

## Intelligent LED Driver (Constant Current)

- Small size and light weight. The housing is made from V0 flame retardant PC materials from SAMSUNG/COVESTRO.
- Support Leading edge (Triac), Trailing edge (ELV).
- With soft-on and fade-in dimming function, enhancing your visual comfort.
- T-PWM™ dimming technology allows continuous and flicker-free images under high-speed photography.
- The whole dimming process is flicker-free with high frequency exemption level.
- Dimming from 0-100%, down to 0.01%.
- Multiple current levels and wide voltage range. Suitable for different power of LEDs.
- Innovative thermal management technology intelligently protects the life of the LED driver.
- Overheat, over voltage, overload, short circuit protection and automatic recovery.
- Up to 50,000-hour life time.
- 5-year warranty (Rubycon capacitor).



**T-PWM™**  
Dimming Technology

**Flicker Free**  
IEEE 1789

Dimmable:  
0.01%-100%

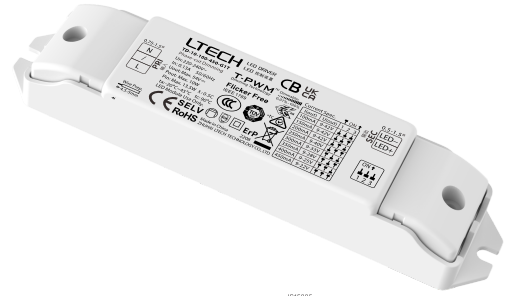

## Technical Specs

Model	TD-10-100-450-G1T	TD-10-350-700-G1T	TD-9-350-700-G1T		
Features	Output Type	Constant Current			
	Dimming Interface	Triac/ELV			
	Output Feature	Isolation			
	Protection Grade	IP20			
	Insulation Grade	Class II (Suitable for class I/ II /III light fixtures)			
OUTPUT	Output Voltage	≤54Vdc	≤35Vdc	≤22Vdc	
	Output Voltage Range	9-42Vdc	9-24Vdc	2-12Vdc	
	Output Current	100-450mA	350-700mA		
	Output Power	Max. 10W		Max. 8.4W	
	Output Power Range	0.9-10W	3.15-10W	0.7-8.4W	
	Dimming Range	0-100%, down to 0.01%			
	LF Current Ripple	<3%			
	Current Accuracy	±5%			
INPUT	Ripple & Noise	≤300mV			
	PWM Frequency	3600Hz			
	DC Voltage Range	200-280Vdc (Dimming is not available)			
	AC Voltage Range	220-240Vac			
	Rated Voltage	230Vac			
	Frequency	50/60Hz			
	Input Current	≤0.13A/230Vac		≤0.12A/230Vac	
	Power Factor	PF>0.5/230Vac, at full load			
	Efficiency (Typ.)	>78%@250mA	>78%@400mA	>72%@700mA	
Inrush Current	Cold start 10A@230Vac (Test twidth=300us tested under 50% Ipeak)				
Anti Surge	L-N: 1KV				
Leakage Current	Max. 0.5mA				
ENVIRONMENT	Working Temperature	ta: -20 ~ 45°C tc: 90°C			
	Working Humidity	20 ~ 95%RH, non-condensing			
	Storage Temperature/Humidity	-40 ~ 80°C/10-95%RH			
	Temperature Coefficient	±0.03%/°C [-20-45°C]			
	Vibration	10-500Hz, 2G 12min/1cycle, 72 min for X, Y and Z axes respectively			
PROTECTION	Overload Protection	Shut down the output and recover automatically once it exceeds 1.02-1.35 times of the rated power			
	Overheat Protection	Intelligently adjust or turn off the current output if the PCB temperature ≥110°C. When the PCB temperature <90°C, automatically recover normal output			
	Short Circuit Protection	When short circuit occurs, shut down the output and recover automatically			
SAFETY & EMC	Withstand Voltage	I/P-O/P: 3750Vac			
	Insulation Resistance	I/P-O/P: 100MΩ/500VDC/25°C/70%RH			
	Safety Standards	CCC	China	GB 19510.1, GB 19510.14	
		CE	European Union	EN 61347-1, EN 61347-2-13, EN 62493	
		KC	Korea	KC 61347-1, KC 61347-2-13	
		TUV	Germany	EN 61347-1, EN 61347-2-13, EN 62493	
		ENEC	Europe	EN 61347-1, EN 61347-2-13, EN 62384	
		CB	CB Member States	IEC 61347-1, IEC 61347-2-13	
		RCM	Australia	AS/NZS 61347.1, AS 61347.2.13	
		BIS	India	IS 15885 (PART 2/SEC 13)	
		EAC	Russia	IEC 61347-1, IEC 61347-2-13	
	EMC Emission	CCC	China	GB/T 17743, GB 17625.1	
		CE	European Union	EN IEC 55015, EN IEC 61000-3-2, EN 61000-3-3	
		KC	Korea	KS C 9815, KS C 9547	
		RCM	Australia	EN IEC 55015, EN IEC 61000-3-2, EN 61000-3-3	
EAC		Russia	IEC 62493, IEC 61547, EH 55015, IEC 61000-3-2, IEC 61000-3-3		
EMC Immunity	EN 61000-4-2,3,4,5,6,8,11, EN 61547				
ErP	Power Consumption	Standby power consumption	No standby mode		
		Networked standby	No networked standby mode (No Phase-cut signal, no power consumption)		
		No-load power consumption	Without no-load mode		
	Flicker/Stroboscopic Effect	IEEE 1789	Meet IEEE 1789 standard/High frequency exemption level		
CIE SVM		Pst LM≤1.0, SVM≤0.4			
DF	Phase factor	DF≥0.9			
OTHERS	Life Time	50000 hours			
	Warranty	5 years			

## LED Current Selection

8 current levels are optional by DIP switch setting

DIP Switch		⬇ ⬇ ⬇	⬇ ⬇ ⬆	⬇ ⬆ ⬆	⬆ ⬆ ⬆	⬆ ⬆ ⬇	⬆ ⬆ ⬆	⬆ ⬆ ⬆	⬆ ⬆ ⬆	ON OFF
TD-10-100-450-G1T	Output Current	100mA	150mA	200mA	250mA	300mA	350mA	400mA	450mA	
	Output Voltage	9-42V	9-42V	9-42V	9-40V	9-33V	9-28V	9-25V	9-22V	
	Output Power	0.9-4.2W	1.4-6.3W	1.8-8.4W	2.3-10W	2.7-9.9W	3.2-9.8W	3.6-10W	4.1-9.9W	
TD-10-350-700-G1T	Output Current	350mA	400mA	450mA	500mA	550mA	600mA	650mA	700mA	
	Output Voltage	9-24V	9-24V	9-22V	9-20V	9-18V	9-16V	9-15V	9-14V	
	Output Power	3.15-8.4W	3.6-9.6W	4.05-9.9W	4.5-10W	4.95-9.9W	5.4-9.6W	5.85-9.8W	6.3-9.8W	
TD-9-350-700-G1T	Output Current	350mA	400mA	450mA	500mA	550mA	600mA	650mA	700mA	
	Output Voltage	2-12V	2-12V	2-12V	2-12V	2-12V	2-12V	2-12V	2-12V	
	Output Power	0.7-4.2W	0.8-4.8W	0.9-5.4W	1-6W	1.1-6.6W	1.2-7.2W	1.3-7.8W	1.4-8.4W	

\* After setting the current via DIP switches, power off and then power on the driver to make the new current setting effective.

\* E.g. LED 3.2V/pcs: 3-24V can power 1-7pcs LEDs in series, 3-14V can power 1-4pcs LEDs, the max quantity of LEDs in series will be subject to the actual voltage of LEDs.

## Product Size

Unit: mm

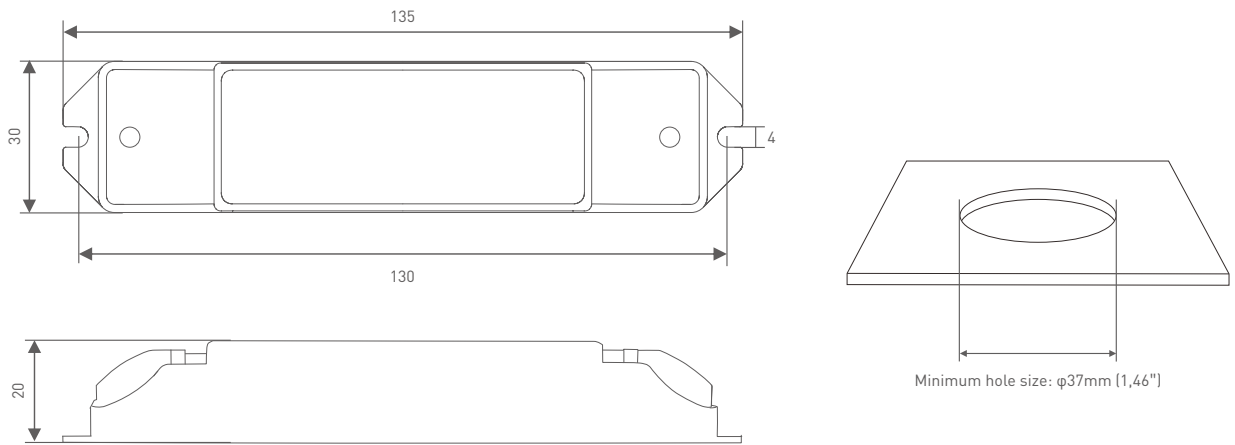

## Wiring Diagram

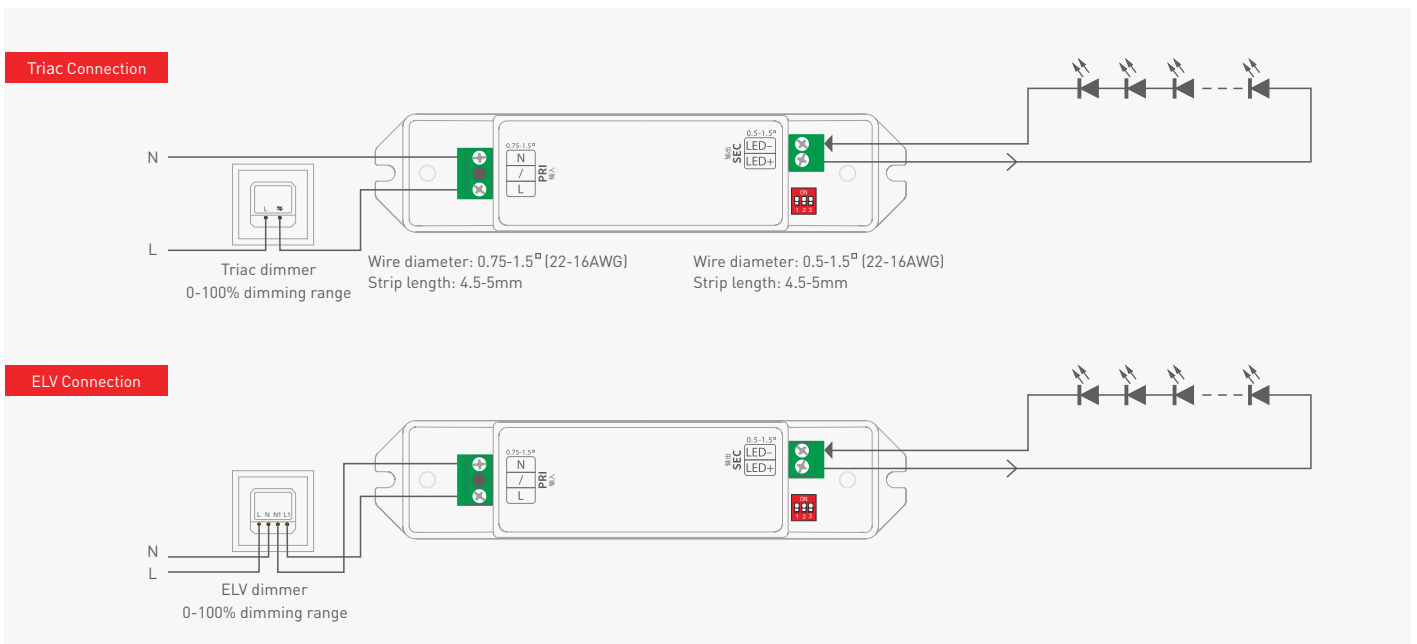

## Installation Precautions

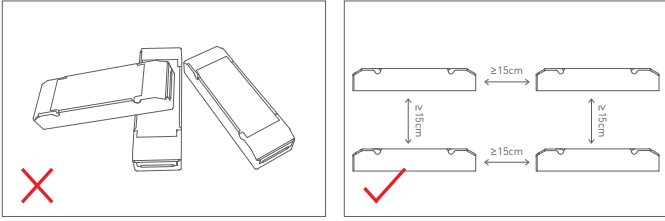

Please do not stack the products. The distance between two products should be  $\geq 15\text{cm}$  so as not to affect heat dissipation and the lifespan of the products.

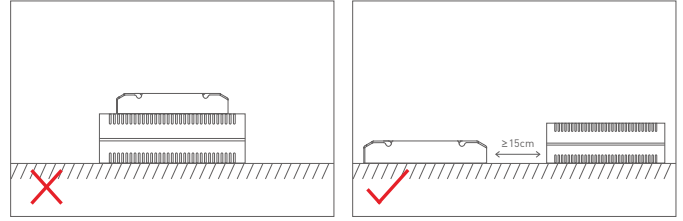

Please not place the products on LED drivers. The distance between the product and the driver should be  $\geq 15\text{cm}$  so as not to affect heat dissipation and shorten the lifespan of the products.

## Relationship Diagrams

Efficiency VS Load

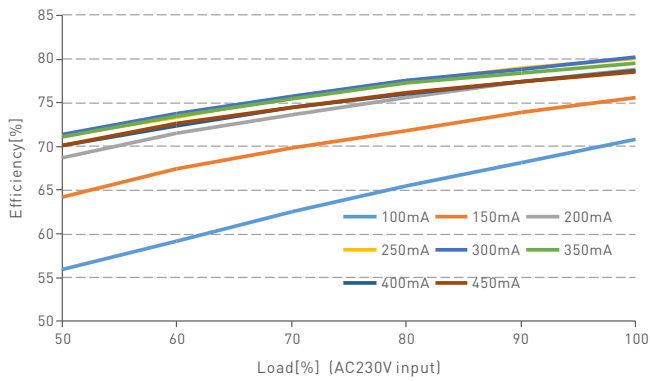

Current VS Voltage

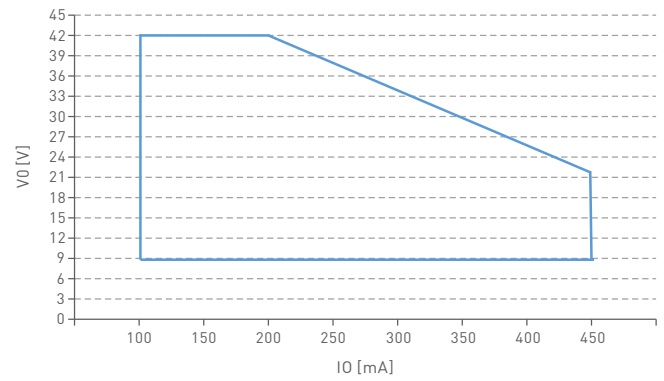

TD-10-100-450-G1T

Efficiency VS Load

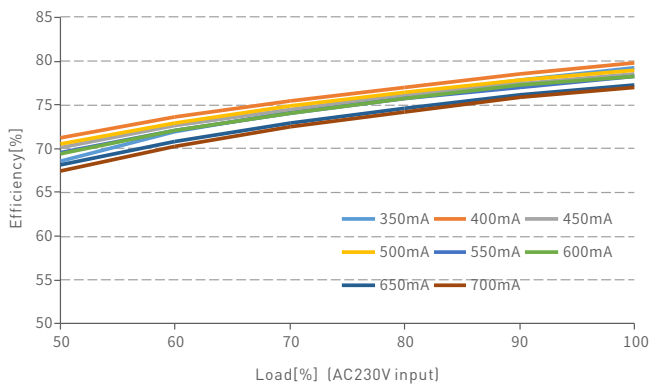

Current VS Voltage

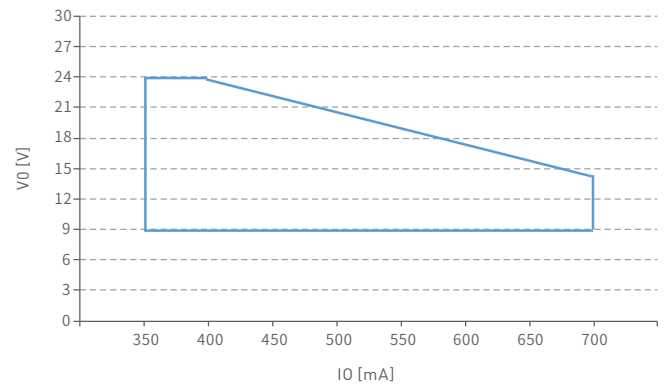

TD-10-350-700-G1T

Efficiency VS Load

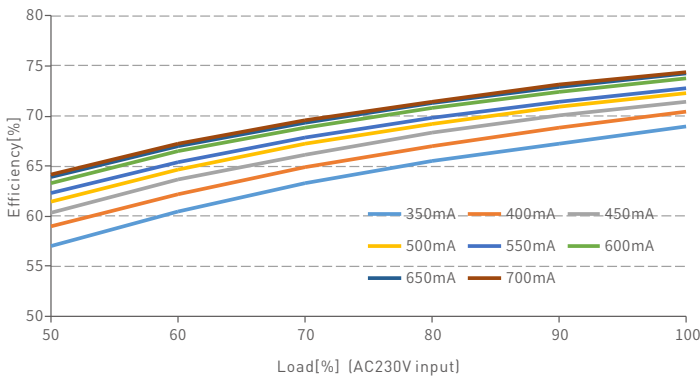

Current VS Voltage

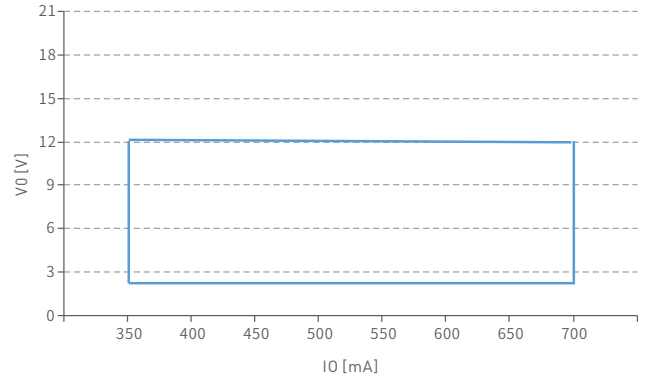

## TD-9-350-700-G1T

## Flicker Test Form

IEEE 1789

Limit of Modulation in low risk area	
Waveform frequency of Optical output	limit [%]
$f \leq 8\text{Hz}$	0.2
$8\text{Hz} < f \leq 90\text{Hz}$	$0.025 \times f$
$90\text{Hz} < f \leq 1250\text{Hz}$	$0.08 \times f$
$f > 1250\text{Hz}$	Exemption assessment
Limit of Modulation in no effect area	
Waveform frequency of Optical output	limit [%]
$f \leq 10\text{Hz}$	0.1
$10\text{Hz} < f \leq 90\text{Hz}$	$0.01 \times f$
$90\text{Hz} < f \leq 3125\text{Hz}$	$[0.08/2.5] \times f$
$f > 3125\text{Hz}$	Exemption assessment (High frequency exemption)

Brightness

- ▲ 0.1%
- ◆ 1%
- ▲ 5%
- ◆ 10%
- 20%
- 30%
- 40%
- ★ 50%
- 60%
- 70%
- ◆ 80%
- ★ 90%
- ◆ 100%

Modulation Area Diagram  
 High Frequency Exemption Area Diagram

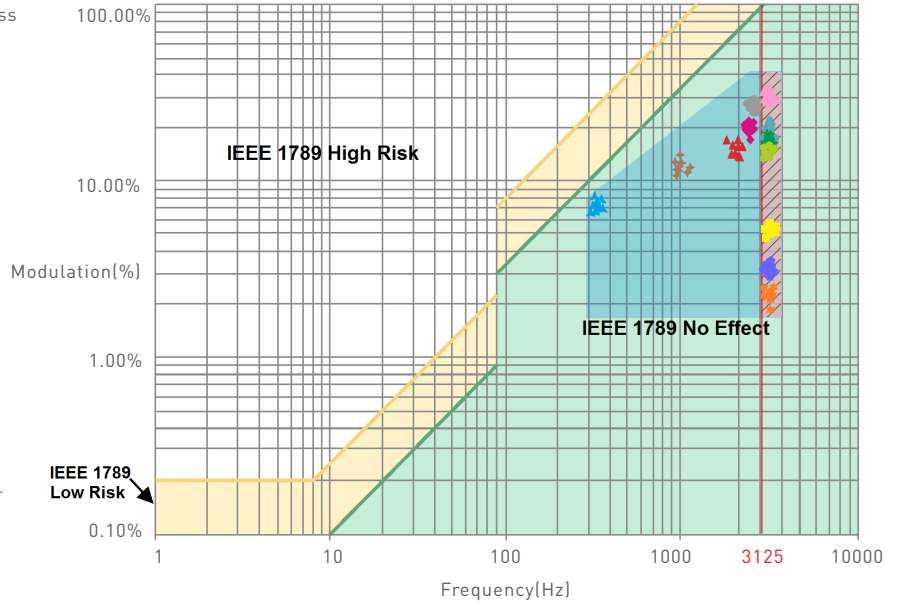

Marks in the right chart were tested results of different current ranges.

The output frequency is 0Hz in 100% brightness and its corresponding modulation is 0%, which could not be shown in the right chart.

## Packaging Specifications

Model	TD-10-100-450-G1T / TD-10-350-700-G1T / TD-9-350-700-G1T
Carton Dimensions	350×285×180mm(L×W×H)
Quantity	30 PCS/Layer; 5 Layers/Carton; 150 PCS/Carton
Weight	0.08 kg/PC; 12.8 kg/Carton

## Packaging Image

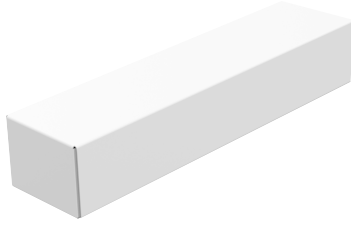

Inner Packaging Box



Carton Packaging

## Transportation and Storage

### 1. Transportation

Products can be shipped via vehicles, boats and planes.

During transportation, products should be protected from rain and sun. Please avoid severe shock and vibration during the loading and unloading process.

### 2. Storage

The storage conditions should comply with the Class I Environmental Standards. The products that have been stored for more than six months are recommended to be re-inspected and can be used only after they have been qualified.

## Attentions

- This product must be installed and adjusted by a qualified professional.
- This product is non-waterproof (special models excepted). Please avoid the sun and rain. When installed outdoors, please ensure it is mounted in a water proof enclosure.
- Good heat dissipation will extend the life the product. Please install the product in a environment with good ventilation.
- Please check whether the working voltage used complies with the parameter requirements of the product.
- Before you power on the product, please make sure all the wiring is correct in case of incorrect connection that may cause a short circuit and damage the components, or trigger a accident.
- If a fault occurs, please do not attempt to fix the product by yourself. If you have any question, please contact the supplier.

\* This manual is subject to changes without further notice. Product functions depend on the goods. Please feel free to contact our official distributors if you have any question.

## Warranty Agreement

- Warranty periods from the date of delivery: 5 years.
- Free repair or replacement services for quality problems are provided within warranty periods.

Warranty exclusions below:

- Beyond warranty periods.
- Any artificial damage caused by high voltage, overload, or improper operations.
- Products with severe physical damage.
- Damage caused by natural disasters and force majeure.
- Warranty labels and barcodes have been damaged.
- No any contract signed by LTECH.

1. Repair or replacement provided is the only remedy for customers. LTECH is not liable for any incidental or consequential damage unless it is within the law.
2. LTECH has the right to amend or adjust the terms of this warranty, and release in written form shall prevail.

## Update Log

Version	Updated Time	Update Content	Updated by
A0	2022.05.19	Original version	Liu Weili