

Electrical installation in on-site mixed and precast concrete.

Boxes, housings and systems.





Service. The easy way.

Innovative brand products from KAISER stand out thanks to the premium, product-orientated service that comes with them. This allows both you and your customers to take advantage of all the benefits they offer.

In simple, intuitive videos, we explain all the benefits of our products and processes. A clever product filter in the online catalogue at www.kaiser-elektro.de helps you to make the right product selection. Tender and specifications, CAD data and BIM data make professional planning easy for you.

- Online product catalogue with many functions for everyday tasks
- Download and request brochures, catalogues, assembly instructions and much more
- Information on seminars, trade fairs and events
- Technical application advice
- Marketing and service numbers
- Product sources of supply
- Article master data, certificates and prices
- Tenders in multiple formats
- BIM data for your planning programme
- CAD data for proper construction

Building Information Modelling. The future in building construction.

Building Information Modelling (**BIM**) opens up a new planning and building culture and is fast becoming the standard in building design. Based on three-dimensional computer models, the planning, execution and operation of a building can be virtually depicted and optimised over its entire life cycle.

In a cooperative planning process with all parties involved, **all geometric and technical data** are successively recorded, supplemented and cross-checked. These data describe, for example, the material, operating life,

environmental or other characteristics such as acoustic or fire protection properties. This allows for the identification and elimination of planning errors, risks, disrupted construction processes, collisions of work sections and unnecessarily high operating costs starting in the early planning stages. This prevents unexpected cost increases during construction and operation.

BIM

For planning, implementation and operation. Support throughout the entire building life cycle with KAISER BIM data.

KAISER provides planners, architects, engineers and specialist firms with extensive support in the planning, implementation and operation of their BIM projects:

The user can directly access the information section on tendering and planning on the KAISER homepage via the link <https://to.kaiser-elektro.de/planung>.

At <https://kaiser.partcommunity.com>, 3D Multi-BIM CAD data are available. Autodesk Revit users can also use the BIMcatalogs.net content plugin. In addition to downloading product data, you can also configure products to suit your specific requirements. After configuring the product, the corresponding CAD model can be generated together with a PDF data sheet and incorporated into the planning and documentation.

All changes in BIM are directly reflected in the orders of magnitude, quantities and costs of the construction project. This allows all project participants to be informed rapidly and also ensures precise cost, schedule, and quality control.

Tenders in all common formats for KAISER products can be found at <http://www.ausschreiben.de/katalog/Kaiser>

KAISER - THE BASIS FOR GOOD INSTALLATION.

Learn more about the
planning tools Scan QR code or visit:
to.kaiser-elektro.de/planung



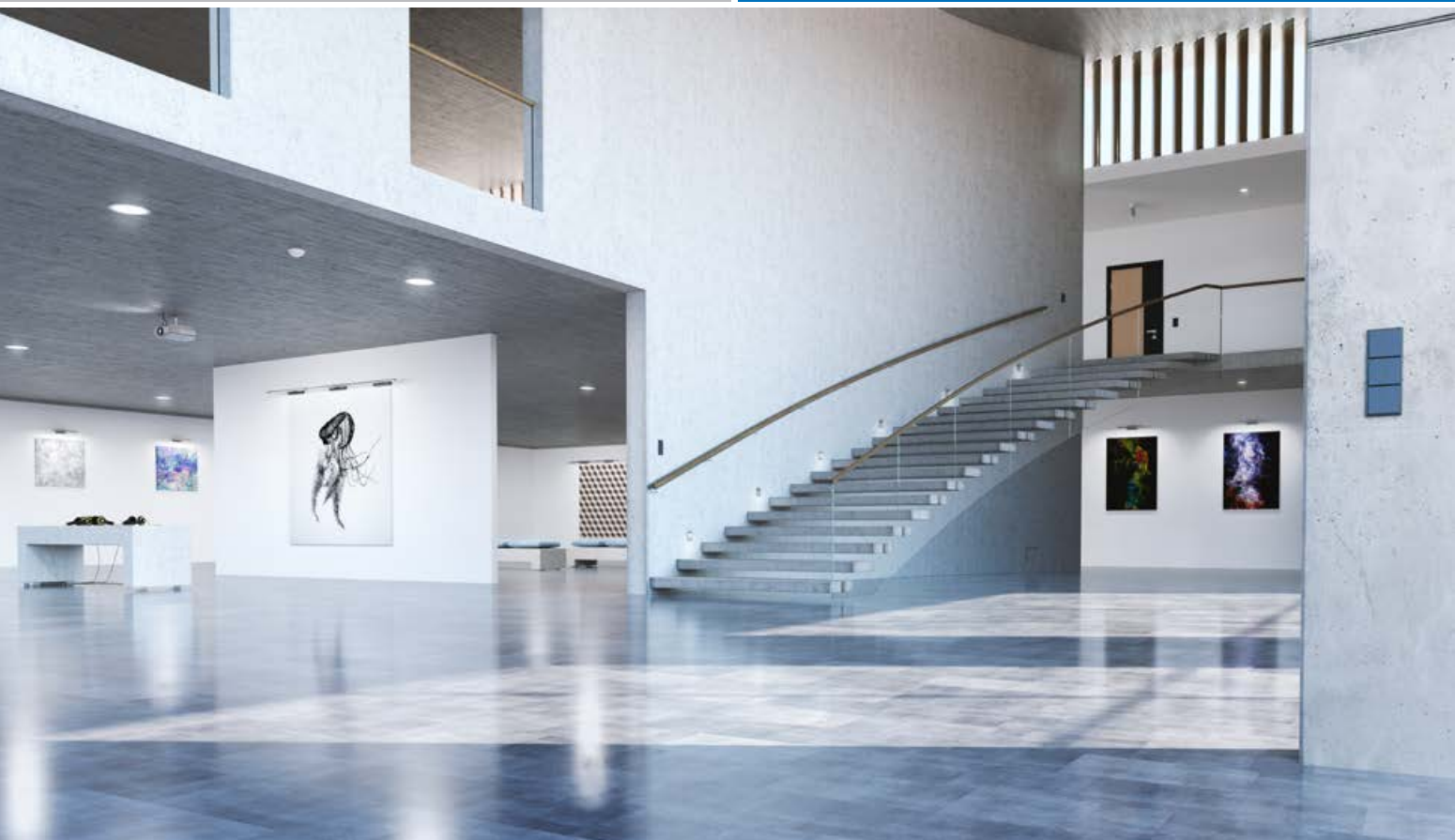

Requirements	Product solutions	
On-site mixed concrete		
The new standard in on-site mixed concrete	On-site mixed concrete	4
One-gang junction box to be fixed to the reinforcement	Prefix® concrete construction box	6
The new standard in on-site mixed concrete	B¹	10
Wall installation	B¹ one-gang and one-gang junction boxes, electronic and two-gang junction boxes, wall exits	12
Practical housing sizes. Robust construction	Junction casings	14
Ceiling installation	B¹ ceiling and ceiling junction boxes, ceiling exits	16
Empty conduit installation	Wall and ceiling transitions, wire-pull and junction casings	18
For continuous empty conduit installation	Wire-pull and junction casings	20
Precast concrete		
The new standard in precast concrete	Precast concrete	22
Simple and efficient concrete construction	System magnet and system magnet PLUS	24
Wall installation	B² one-gang junction boxes also for automated production, conduit connectors, extension element	26
Ceiling installation	Slab ceiling box 115 also for automated production, 105 also for retrofitting	28
Transitions for wall and ceiling	Wall and ceiling transitions	30
Solutions for simplified opposing installation	Prefix® universal support	33
Luminaire and loudspeaker housings		
Solutions for luminaires and loudspeakers	System HaloX®	34
Installation housing for on-site mixed concrete	HaloX® for on-site mixed concrete	38
The solution for a clean ceiling appearance after plastering	Signal cover	42
Installation housing for precast concrete	HaloX® for precast concrete	44
Variable installation compartment for various installation accessories	Universal installation housings for concrete ceilings and walls	48
For retrofitting in slab ceilings and solid concrete ceilings.		50
Facing concrete		
Highest requirements for appearance.	Boxes, housings and transitions for facing concrete	52
Electrical installation in concrete. At a glance.		54
KAISER PRODUCT RANGE. Solutions and systems for professional electrical installation work.		60

On-site mixed concrete.

On-site mixed concrete is typically used for the production of large parts and surfaces. Here, the fresh concrete, delivered or mixed on site, is filled into the formwork prepared with reinforcement and installation components and then compacted. After curing, the formwork is removed and the walls or ceiling slabs are finished.

Wooden formwork is usually used for on-site mixed concrete. These formworks may also be coated with plastics or synthetic resins. The boxes are attached to the formwork by simply nailing them on, thus ensuring a secure hold. Fastening to steel formwork is usually done with expansion anchors, magnets, adhesive foils or hot glue.

The modular KAISER system is universally applicable for all concreting methods and formwork types. The perfectly coordinated individual modules guarantee exact planning and smooth processing with future-proof installation. Robust Prefix® supporting and connecting elements as well as extensive accessories and tools complete the programme in a practice-oriented way. The different colours of the individual components facilitate correct assembly.

The installation of the boxes, housings and systems is carried out with empty conduits for the feed lines. Boxes and conduits form a closed system. All connections of the multi-part products to each other as well as to conduits and cables are precisely matched. The connection openings are made with standard tools, without tools or with KAISER system tools, so that the stability and absolute tightness of the entire system is ensured and no concrete can penetrate into boxes, housings, casings or empty conduits.

- 1 HaloX® 100 multi-conduit entry
- 2 B¹ universal ceiling exit
- 3 HaloX® 250 with tunnel 325 for on-site mixed concrete, HaloX®250 universal front part
- 4 Formwork protection
- 5 B¹ one-gang junction box
- 6 HaloX® 100 for on-site mixed concrete, HaloX® 100 front part, square
- 7 B¹ ceiling junction box
- 8 HaloX® 180 with tunnel 190 for on-site mixed concrete, HaloX® 180 facing concrete front part
- 9 B¹ one-gang junction box, B¹ Prefix®-system wing set
- 10 B¹ one-gang junction box,
- 11 Prefix® concrete building boxes
- 12 Wall and ceiling transition 30°, B¹ Prefix®-system wing set, B¹ Prefix® wall outlet adapter Ø 25 mm
- 13 Equipotential bonding casing 16²



Find out more about the **on-site mixed concrete solution area**.
Scan QR code or visit:
www.kaiser-elektro.org/de94

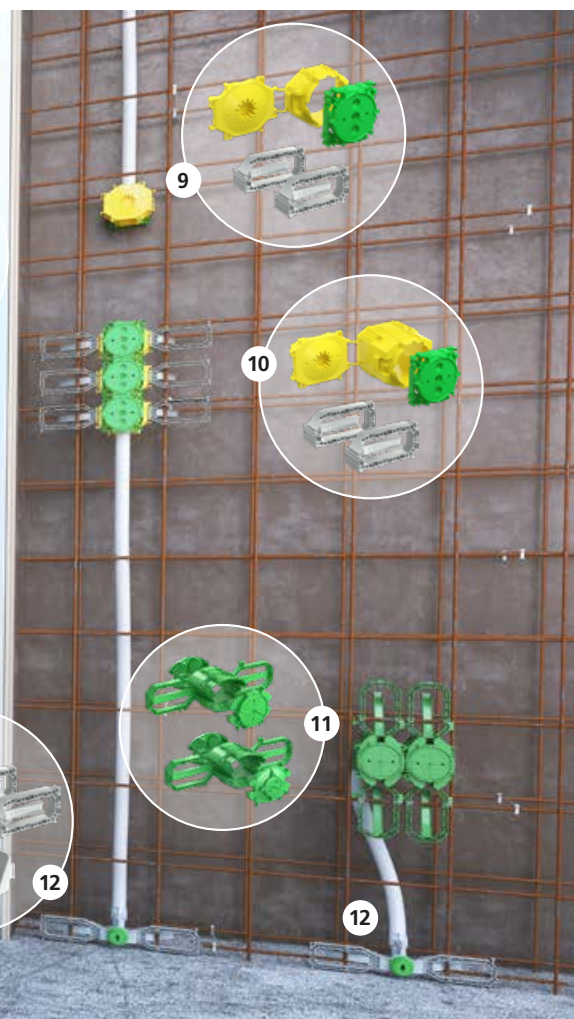

Prefix® concrete construction boxes.

NEW

INSTALLATION



Fixing by means of tie wires or cable ties



Easy opening of the required conduit and line openings



Simple pre-fixing with Prefix® installation technology

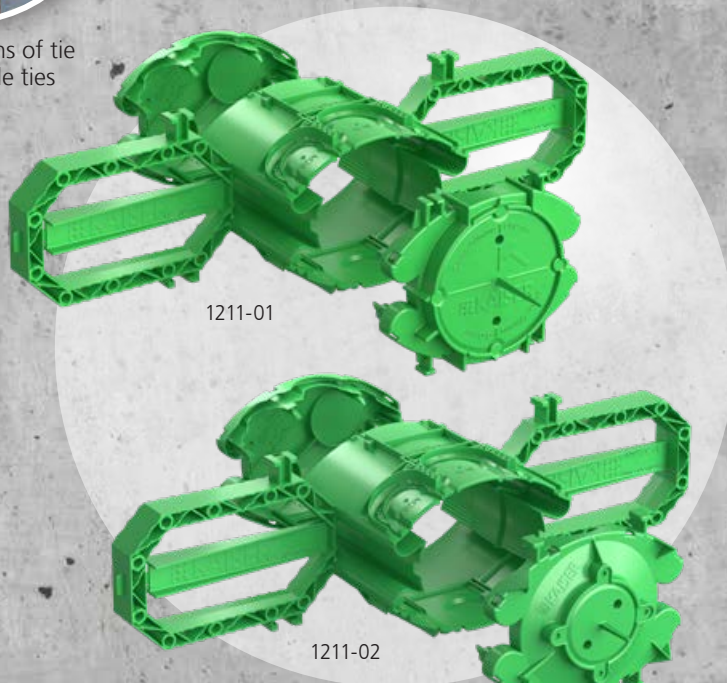

1211-01

1211-02



Centre marking for easy alignment using laser spirit level.



Entry limits at the outer conduit entries
– No subsequent shortening of the conduits required



Sturdy signal bristle and bold colouring for easy retrieval



Stable and secure connections on front part and PREFIX® Wing



The new Prefix® concrete construction boxes.

The new Prefix® concrete construction boxes, in addition to the proven product features such as lateral installation clamps for fastening to the reinforcement, mounting clips for pre-fixing the items and marked wave profile for an exact and secure fit, now also have innovative conduit entries, insertion options in the rear part of the box as well as separators that can be broken out at a later date for connecting devices in combinations.

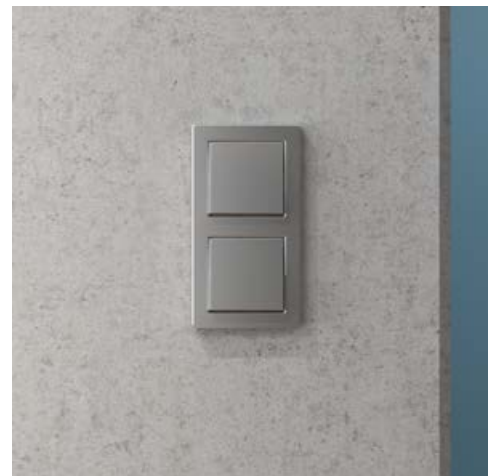
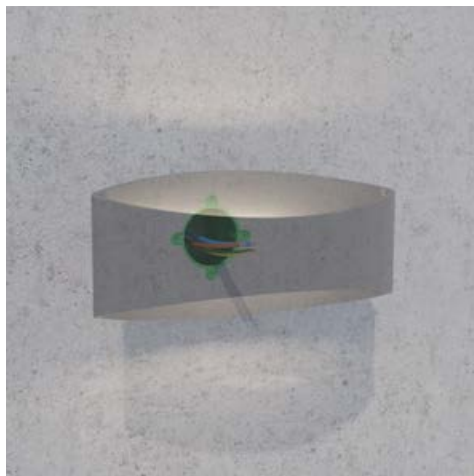

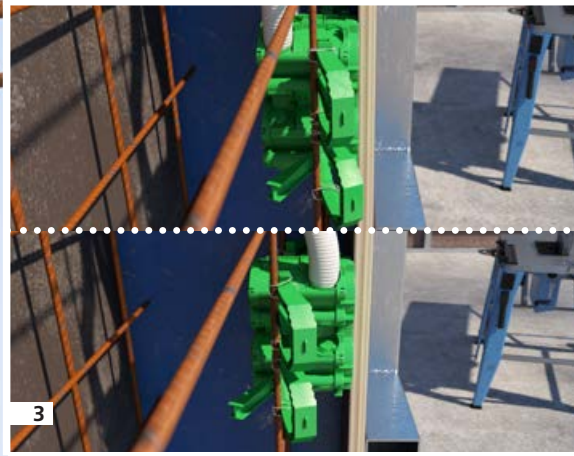
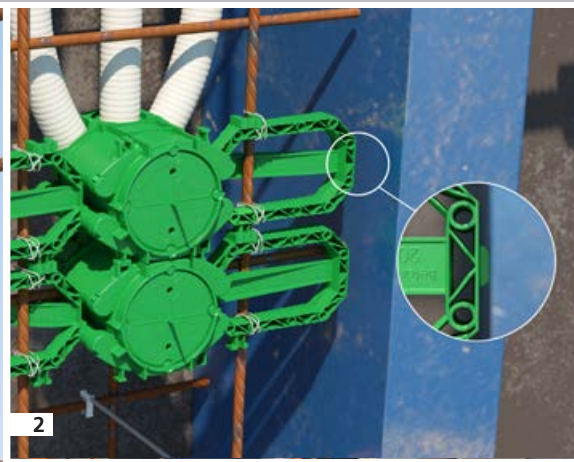

The new Prefix[®] – 10 times better.

- 1 The simple and fast installation for opposing formwork without support element and abutment ...
- 2 ... as well as lateral spacers ensure complete flow around the concrete and allow facing concrete installations even in passage and edge areas
- 3 Suitable for 20 - 60 mm concrete covers
- 4 Innovative conduit entries \varnothing 25/32 mm and \varnothing 20/25 mm, for fast processing on the construction site
- 5 Insertion options up to \varnothing 25 mm on the rear base of the box
- 6 Easy assembly by hand
- 7 Stable signal bristle and strong colouring for easy retrieval in the concrete surface
- 8 Large assembly and installation clearance
- 9 Convenient installation of pre-wired installation accessories in multiple combinations by ...
- 10... means of a subsequently breakable bridge

Adjustment to the respective concrete cover

Concrete cover 20 - 40 mm



The assembly of the box for a concrete cover of **20 to 40 mm** is carried out by installing the conduit entries at the bottom of the box.

This means that the conduit entries are located behind the first reinforcement layer and that time-consuming and destabilising reinforcement cuts are no longer necessary.

Concrete cover 40 - 60 mm



A concrete cover of **40 to 60 mm** is also possible by simply turning the box upside down. For this purpose, the conduit entries must be arranged on the front part.

Thus, the conduit entries are located in front of the first reinforcement layer and also remain usable without restrictions. The conduits are to be routed behind the reinforcement at the earliest opportunity.



4

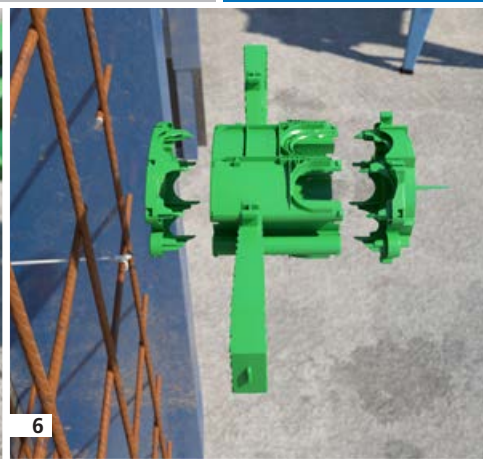

6

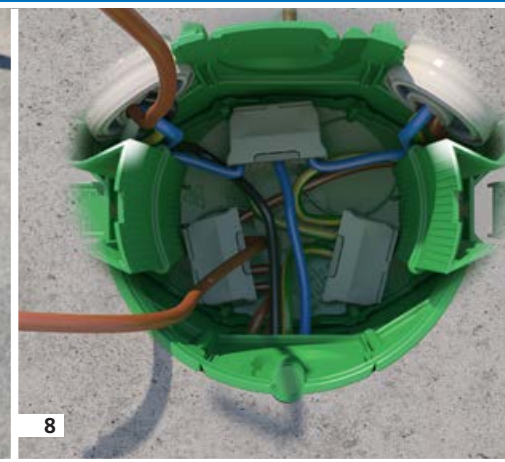

8

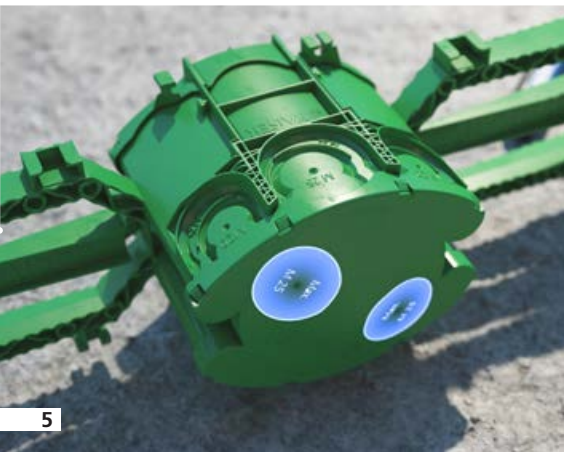

5



7



9

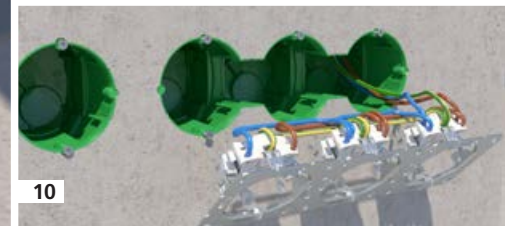

10

Packed full of innovative functions, the new **Prefix® one-gang junction boxes** and **Prefix® wall light connection boxes** offer new market-orientated product features, noticeably easier handling as well as improved efficiency on the construction site.

The Prefix® concrete construction boxes allow a simple and quick installation to the opposing formwork without support element and abutment, with safe concrete tightness.



VDE certified



Product video
Insertion work



Product video
Installation

Prefix® concrete construction box 60
One-gang junction box
Art. No. 1211-01

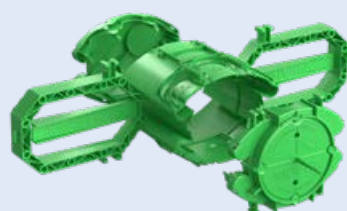

Prefix® concrete construction box 35
Wall light connection box
Art. No. 1211-02

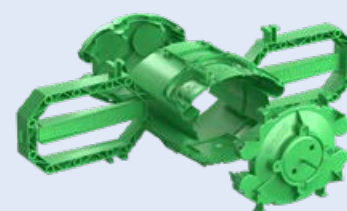

Universal opening cutter for creating exact openings for cable and conduit entries in plastics
Step drill Art. No. 1284-32

B1

The new standard in on-site mixed concrete.

INSTALLATION

INSTALLATION



Installation of pre-wired sockets



Bridges are easy to break out



Innovative conduit opening



All B1 wall applications have 2 stable slots for Prefix® system wings



Firmly combined on the front part and box body

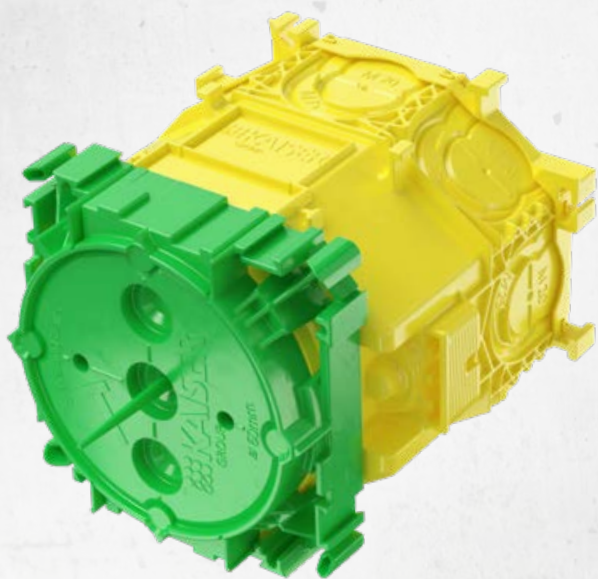

... and for the **Wall.**

INSTALLATION

The first choice for the Ceiling ...

Precisely break out the pipe connection opening



Latch the rear part onto the front part



Simply close the cover by hand



Simply insert the conduits into the prepared openings



Signal bristles for easy location of the boxes after removing the formwork

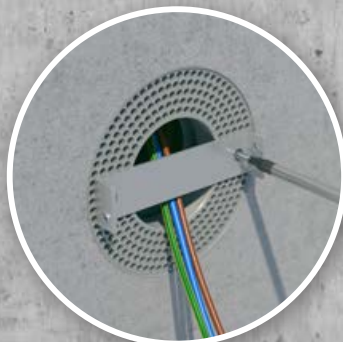

Easy and quick unit installation without drilling

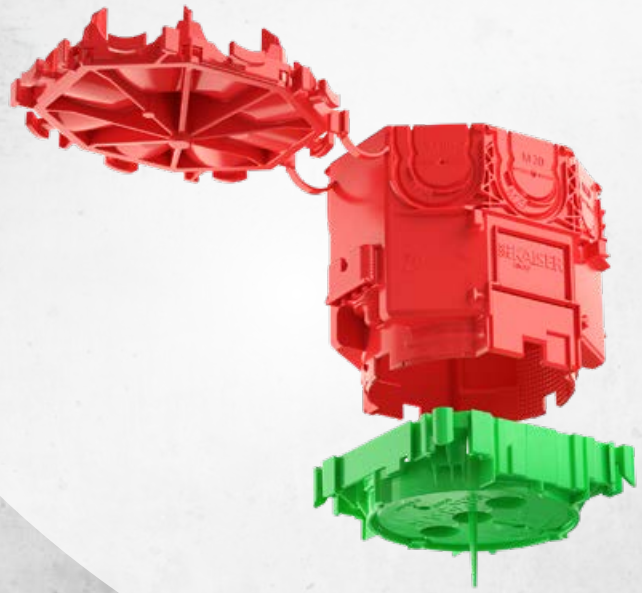

Product video Installation



Product video Installation/Insertion work

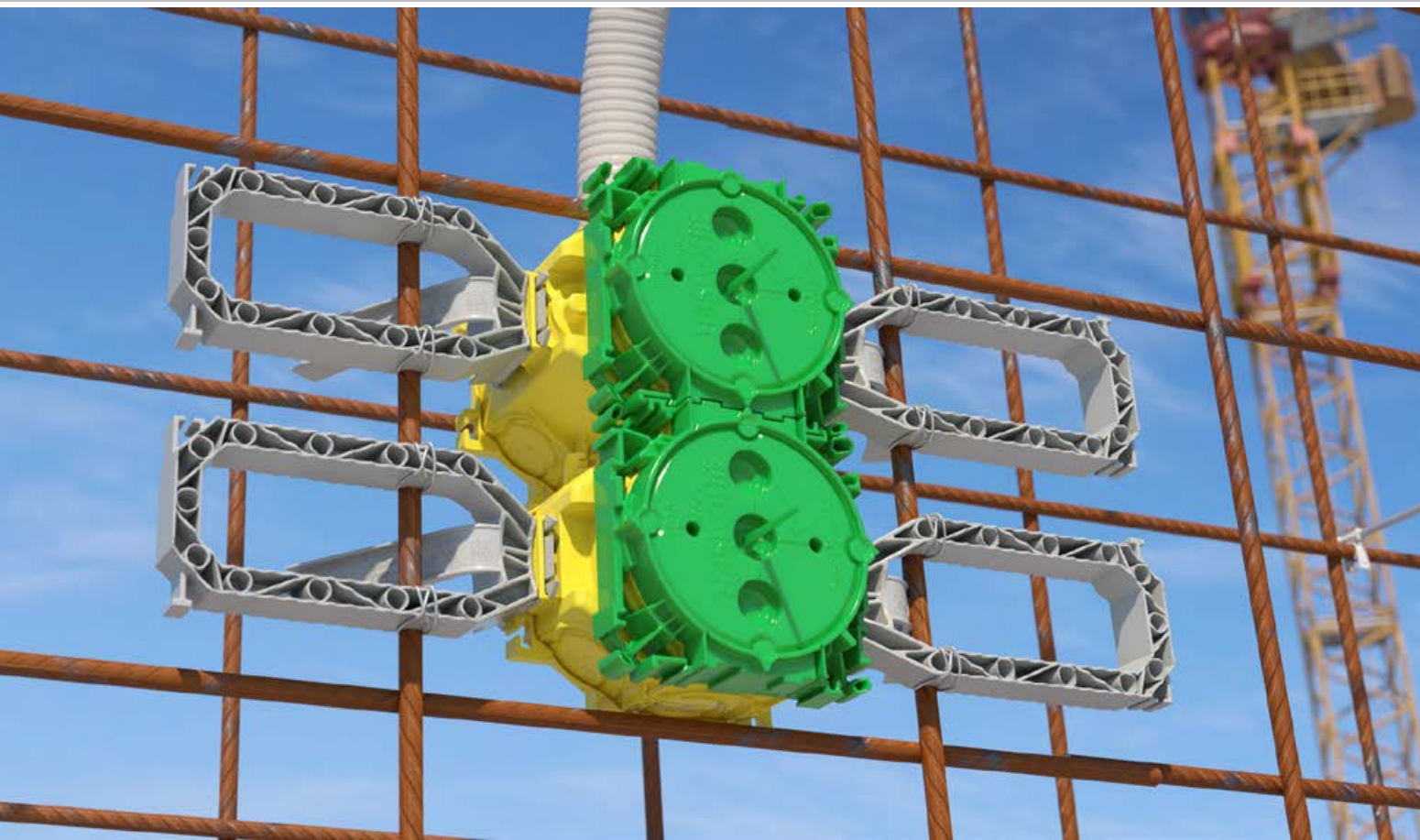

On-site mixed concrete: B¹ Wall installation.

NEW

The new B¹ concrete construction programme is optimally tailored to the construction site and installation practice. The insertion and installation work is based on the latest technology in handling and function. The electrical installation in the wall performed after removal of the formwork is also equipped with many innovative features and functions for a modern installation. Thus, a comprehensive range of boxes is available, e.g. one-gang boxes, one-gang junction boxes and electronic boxes. This allows you to quickly and precisely prepare the installation for all types of flush-mounted inserts such as switches, sockets or LED luminaires as well as the associated wiring. With the new stable connector system, you can connect the front part and the box body securely, making it easy to create any combination.

The improved support system gives the components a secure hold in the vertical formwork. One-gang boxes that are mounted to the working formwork with dowels or nails do not require any further securing except in anticipation of extreme loads. Boxes or housings that are fastened with magnets or hot glue must be supported on the second side of the formwork. If no boxes or housings are provided on the working formwork (e.g. on an outside wall), but rather on the opposing formwork side, abutments can be mounted on the working formwork and the required spacing can be created with support elements or conduits.



The new Prefix[®] system wings can be attached to all box bodies. Each B¹ box is equipped with two slots for Prefix[®] system wings to allow easy installation without support.



1

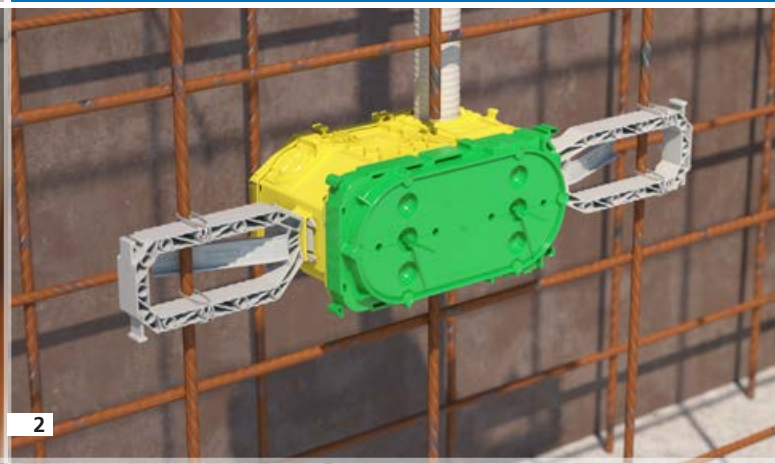

2

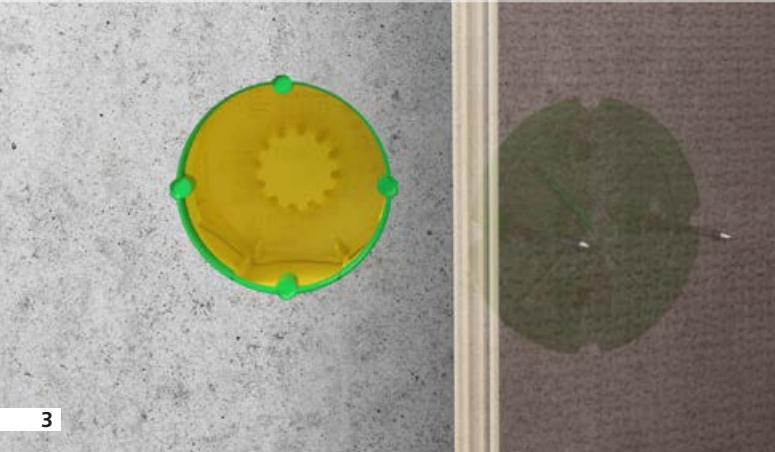

3

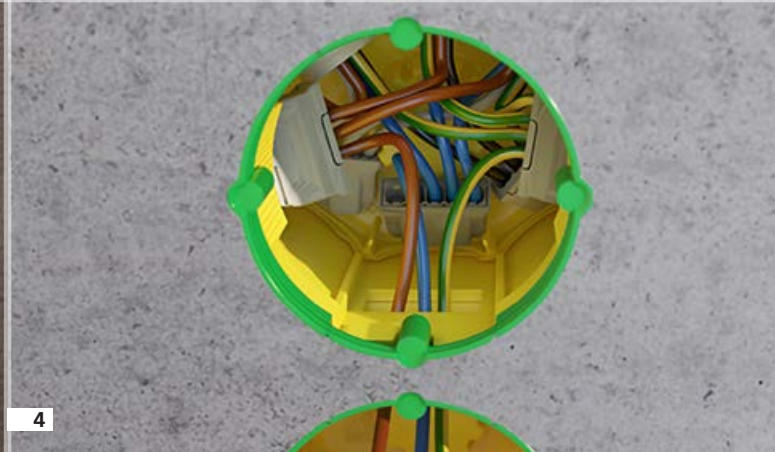

4

- 1 Conduits can be inserted into the innovative conduit opening in a controlled manner. The box bottom can be closed securely by hand.
- 2 All box bodies are equipped with slots for Prefix® system wings to allow easy installation to the opposing formwork.
- 3 The plaster skin tears when the formwork is removed or can be opened with a hammer blow.
- 4 With a large installation space and various possibilities for cable feed-through in combinations, the boxes offer maximum convenience during accessory installation.

B' device box

Art. no 1255-01

B' connecting box

Art. No. 1265-01

B' large-conduit one-gang junction box,

Art. No. 1260-01

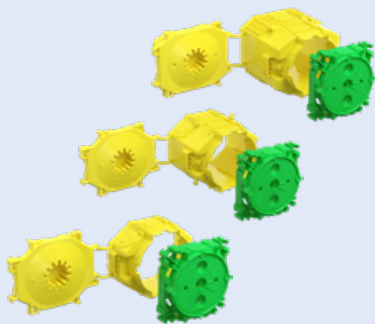

B' Wall light connection box

Art. No 1248-01

B' Universal wall exit

Art. No 1248-03

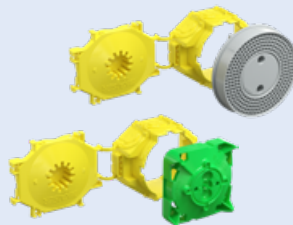

Distance piece 91

Art. No. 1259-04

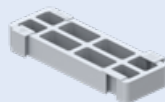

B' Electronics box

Art. No 1268-01

B' Two-gang junction box

Art. No 1269-01

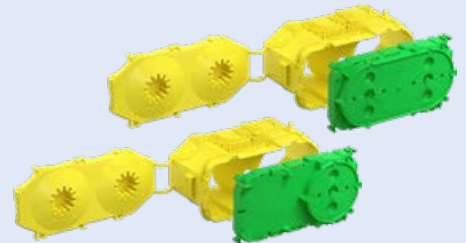

B' Prefix® system wing set

Art. No. 1211-00

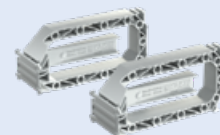

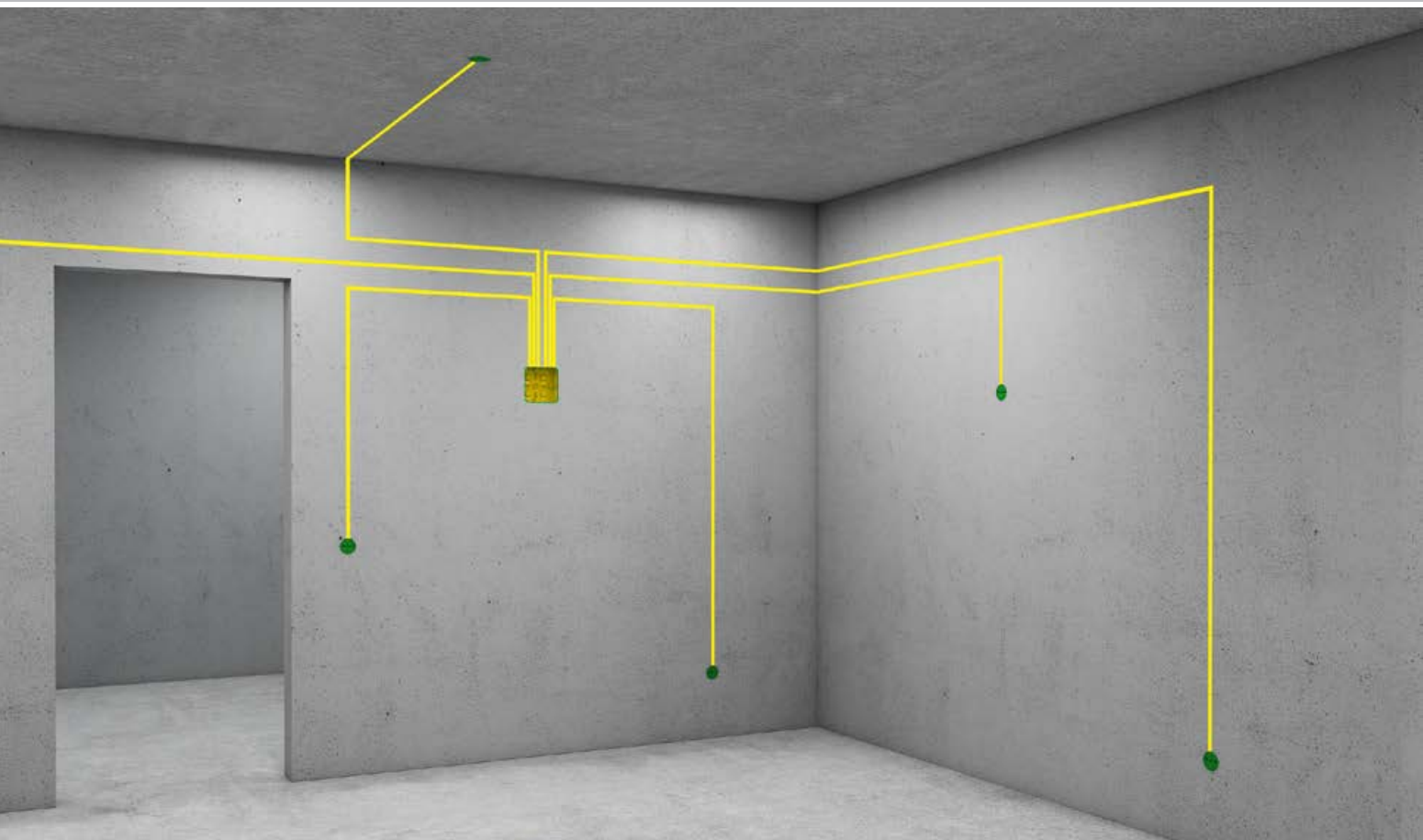

Junction casings in all sizes and for all purposes. Practical housing sizes. Robust construction.

Using junction casings for the electrical installation offers a lot of flexibility and freedom for future modifications to the electrical system. The complete wiring for this type of installation is done according to DIN 18015-3 in a central junction casing from which all supply lines are routed radially to switch and light sources. Pulling the cables through the empty conduit system is also easier to manage when using junction casings.

In case of changes of use of spaces at a later time, lighting groups, for example, can be re-assigned to a circuit quickly and easily by changing the wiring in the junction casing. To accommodate different electrical circuits, the junction casings can be wired separately in a standardized manner by using separator walls. Depending on the junction casing size, cable cross-sections of up to 16 mm² can be inserted and wired.

Once the wiring work is complete, all junction boxes can be closed by means of an end cap with a screw fastening in accordance with VDE regulations.



1

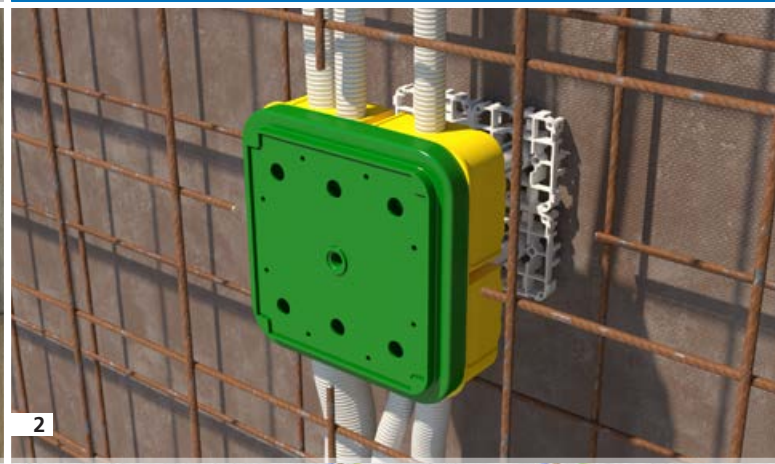

2

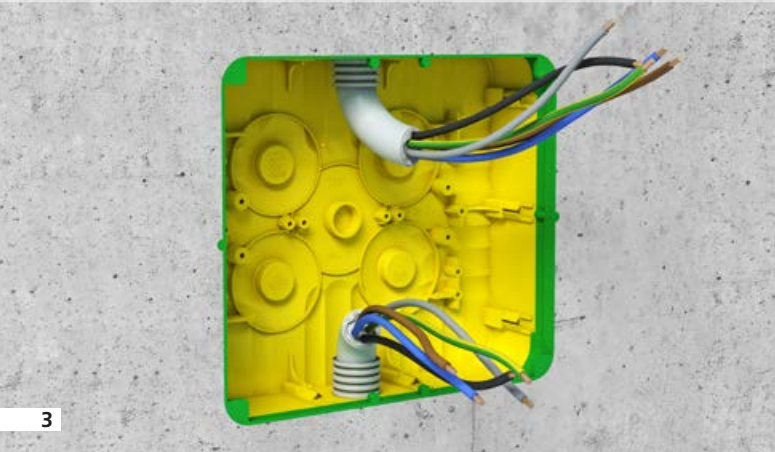

3

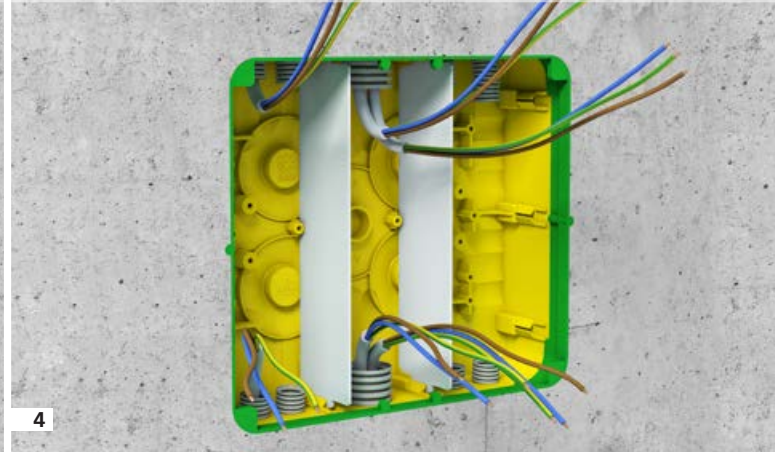

4

- 1 Junction casings have a generous surface area to accommodate installation conduits up to Ø 40 mm
- 2 For installation on the opposing formwork side, the rear part of the junction casing has slots for support with one or more support elements with abutments
- 3 KAISER junction casings offer plenty of space for professional electrical installation according to DIN 18015-3
- 4 Separator walls ensure that electrical circuits are safely separated

Junction casing
128 x 128 x 80 mm
Art. No. 1295-02



Junction casing
180 x 180 x 84 mm
Art. No. 1296-02



Junction casing
250 x 220 x 82 mm
Art. No. 1297-02



For more junction casings, see page 21.

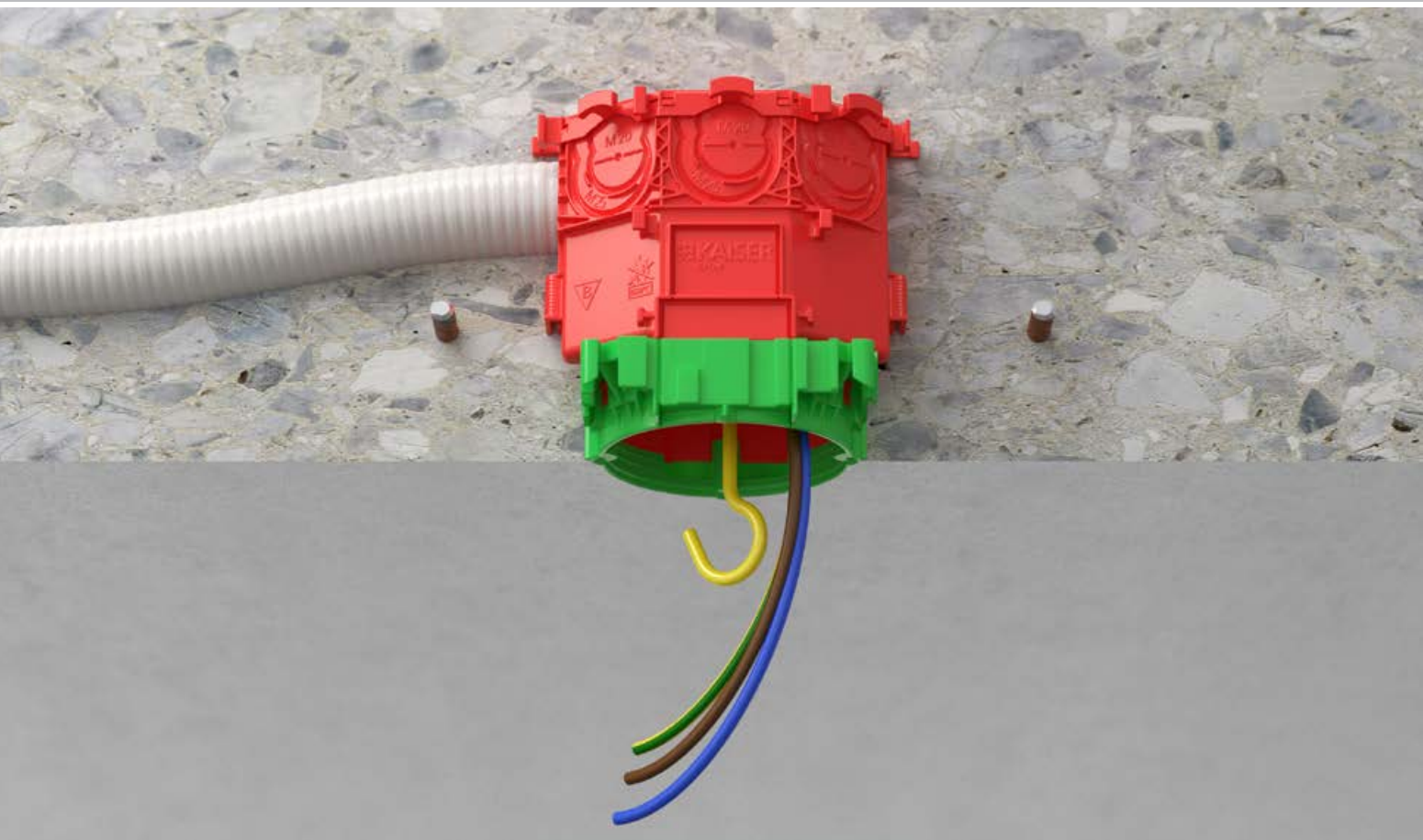

On-site mixed concrete: B¹ Ceiling installation.

NEW

The new ceiling boxes and proven ceiling elements guarantee stable and accurate installation openings with high installation comfort. The KAISER range offers installation boxes with flexible conduit entry options up to M40 for all ceiling applications. Screw-in, fully insulated light hooks provide a secure fit. Exits with openings of Ø 35 or Ø 60 mm always offer sufficient space for convenient installation and, if required, a universal screw-on surface for quick and easy installation.

The new B¹ ceiling boxes with innovative conduit entries enable conduits to be easily inserted into several ceiling boxes arranged in a row without having to cut them during the laying work. Due to the conduit entries located higher up, additional cut-outs of the reinforcement bars are unnecessary, ensuring fast insertion of the empty conduits on the ceiling.

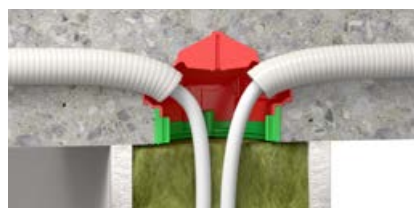

The small ceiling boxes, for example, are suitable as domed boxes for partition walls.



Universal mounting surface:

The screws used to attach the accessory can be simply screwed into the universal mounting surface.

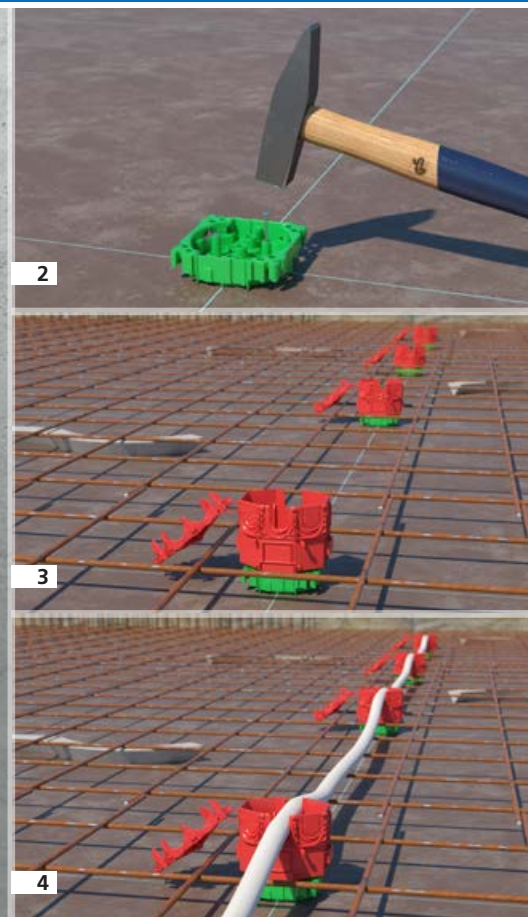
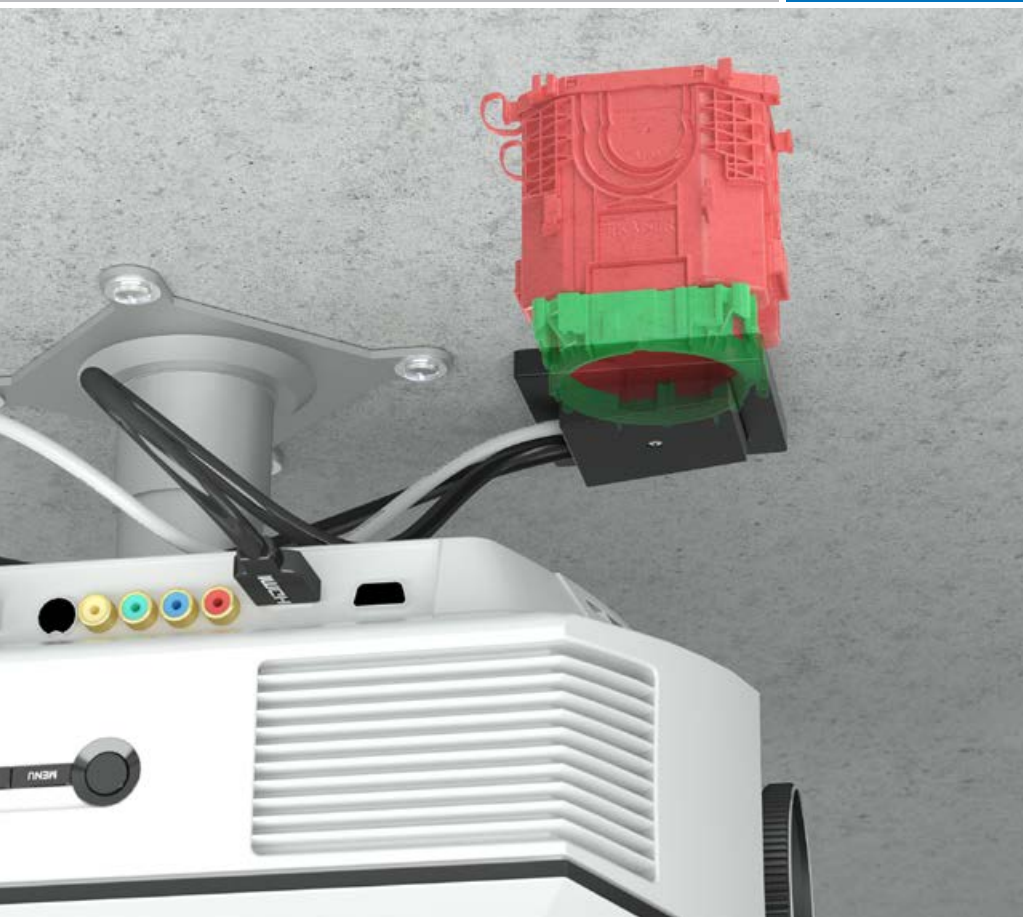

B¹ large conduit ceiling junction box with conduit entry options up to M40. Ideal for pre-assembled cables.

- 1 The shallow front part allows easy fixing to the ceiling formwork before the reinforcement bars are added.
- 2 The conduit entries are above the lower reinforcement layer, so that no cutting of the reinforcement bars is necessary.
- 3 The advantage of the new conduit entry is that empty conduits can be inserted in several ceiling junction boxes without cutting the conduit beforehand.

B¹ ceiling junction box
Art. No. 1265-11
Art. No. 1265-12

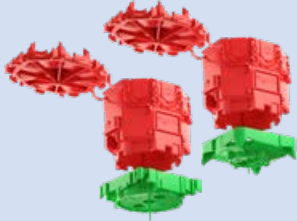

B¹ large conduit ceiling junction box
Art. No. 1260-11

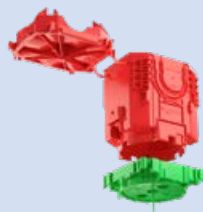

B¹ universal ceiling exit
Art. No. 1249-13
Art. No. 1265-13



B¹ 45° domed box
Art. No. 1249-11
Art. No. 1249-12



Large slab ceiling box 115
Art. No. 1227-50



Slab ceiling box for retrofitting
Art. No. 1247-01



Universal ceiling and wall exit
Art. No. 9959



Ceiling exit
Art. No. 9955



Light hook
Art. No. 1225-.../1226-...





Wall and ceiling transitions.

For empty conduit installation in on-site mixed concrete.

End and transition bushes as well as wall and ceiling transitions ensure a continuously functioning empty conduit system at transition points. The particularly compact design of the end and transition bushes enables conduit outlets to be easily arranged - even between closely spaced reinforcement bars and without needing to adjust the bars. The optimum elbow radius of the wall and ceiling elbow fittings, and their precisely fitting conduit entries, avoids the occurrence of protruding edges at interfaces, thus ensuring that cables can be freely inserted from both ends.

- Small design for easy installation between closely spaced reinforcement bars
- Easy cable entry due to optimal transition radius
- Installation on the opposing formwork with support element and abutment
- 2-part design with secure catch mechanism
- Easy removal of the plaster skin
- Small visible surface, clean wall or ceiling appearance

Wall and ceiling transition 30°

B¹ Prefix® system wing set

B¹ Prefix® wall exit adapter

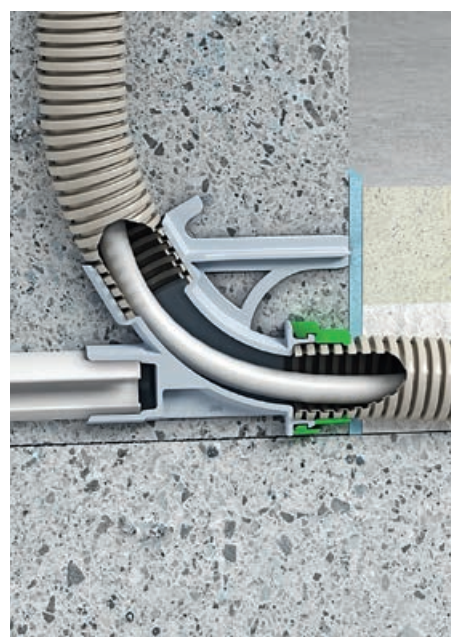
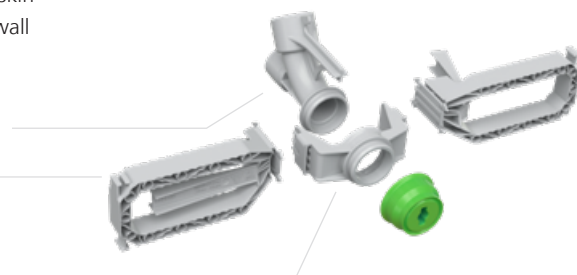

The optimal radius of the transitions ensures flexibility when pulling cables in.

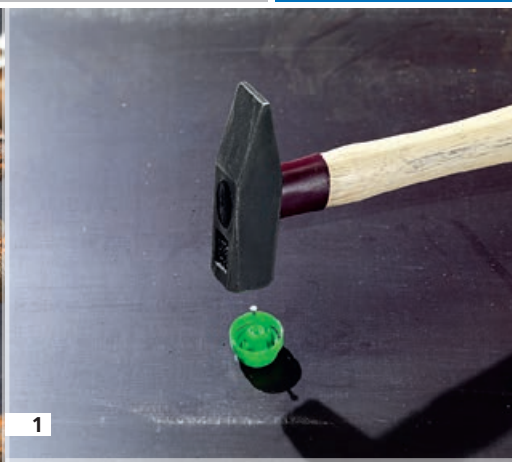

The particularly compact design of the end and transition bushes enables conduit outlets to be easily arranged - even between closely spaced reinforcement bars and without needing to adjust the bars.

- 1 The flat front part allows easy fixing with only one nail.
- 2 The new snap-in connection offers a secure connection between the front and rear parts.
- 3 Installation on the opposing formwork with an adapter and a Prefix® system wing set.
- 4 Quick and easy wall exit attachment to the reinforcement with Prefix® installation technology.



Product video

End and transition bush
Art. No. 1204-24/34/29



End and transition bush
Art. No. 1203-28

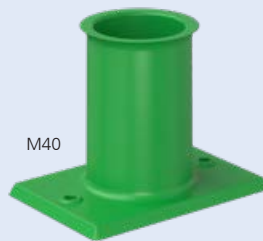

Wall and ceiling transition 30°
Art. No. 1202-04/34/29



B1 Prefix® wall exit adapter
Art. No. 1211-20/25/32

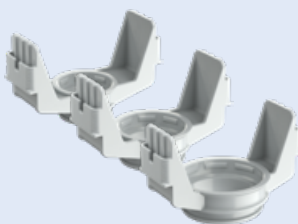

B1 Prefix® system wing set
Art. No. 1211-00



Ceiling strip / Formwork protection
Art. No. 4551 / 1283-... / 4558 / 4552

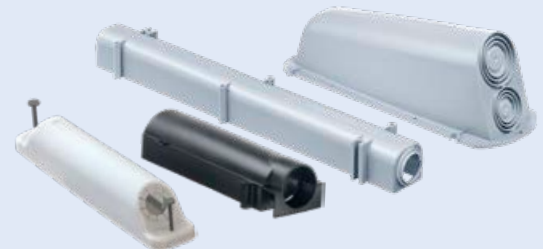



Wire-pull and junction casings.

For continuous empty conduit installation.

KAISER wire-pull casings ensure professional cable routing through conduit networks. According to DIN 18015-1, conduit lengths of more than 15 m as well as more than two bends require wire-pull casings which allow for the re-tightening or retrofitting of cables at any time.

Wire-pull casings provide multiple conduit entry options and maximum free space to ensure a continuous cable network, including with subsequent changes to the electrical installation.

- Quick and secure installation due to pre-assembled nails
- Simple mounting in the wall using Prefix® installation technology
- High dimensional stability, no internal support required
- Versatile conduit entry options
- In case of sub-ceiling insulation, it can be extended via intermediate frames
- Clean stripping where facing concrete is required
- Maximum space for pulling cables through and for cable retrofitting





1



2



3



4

- 1 Fastening to the ceiling formwork occurs by means of 8 pre-installed nails. The nail domes have a predetermined breaking point, so that the nails are also removed together with the formwork removal.
- 2 Tie lugs attached to the back wall provide additional security during fixing if extreme loads are expected.
- 3 The conduit entries can be easily opened using a step drill or a hammer and screwdriver. If multiple different conduits are to be connected, the side walls can be removed using a hammer.
- 4 Also suitable for wall mounting - to be fastened to the reinforcement via Prefix® installation technology.

Wire-pull casing
Art. No. 9916



Wire-pull casing
Art. No. 9916.21



Wire-pull casing
Art. No. 9917



Wire-pull casing
Art. No. 9917.21



Upper frame
Art. No. 9917.68 / 9916.68

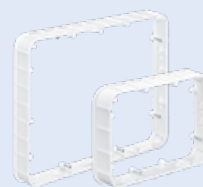

Plaster cover
Art. No. 9917.06 / 9916.06



Screw-on cover
Art. No. 9917.02 / 9916.02



Waterproof cover
Art. No. 9917.03 / 9916.03



Prefix® wing set
Art. No. 9940..



Precast concrete.

Prefabricated elements (precast concrete) are well suited for the series production of individual elements. They are manufactured completely or partially in concrete factories. This type of construction is characterised by high efficiency due to short installation times, weather-independent production and the consistent quality of the ceiling and wall elements.

The high degree of automation in horizontal production on steel formwork tables ensures high-precision and fast production runs. Mounting and fixing an installation system on the steel formwork must be carried out precisely, securely and rapidly. For this operation, where every minute counts, magnets, hot glues or adhesive films are used. For precast concrete, too, KAISER provides a practical system with various fixing and supporting options in order to guarantee trouble-free production.

A crucial factor for maximum efficiency for concrete construction in precast concrete is the production lead times. The set-up times for reinforcement and electrical installation play a significant role here - especially in computer-controlled factories with circulation systems. A decisive factor for further processing on the on-site mixed concrete construction site is the quality of the pre-installation and therefore the cost-reduced further processing (installation) in walls and ceilings.

The KAISER programme for precast concrete consists mainly of the B² system with one-gang junction boxes as well as special slab ceiling boxes and housings. This programme is supplemented for precast concrete with intelligent products for conduit installation such as wall to ceiling transitions and oval funnels for faster wall installation. In addition to these products, which have been specially developed for precast concrete, all KAISER on-site mixed concrete products can also be used in precast concrete.

- 1 Wall to ceiling transition 90°, oval funnel
- 2 Large slab ceiling box 115 for magnet attachment
- 3 HaloX® 250 with tunnel for precast concrete for magnet attachment
- 4 B² device junction boxes for magnet attachment
- 5 One-gang junction box without plaster skin with 68.5 mm depth
- 6 One-gang junction box with plaster skin, universal extension element 175 to 300 mm
- 7 Wall and ceiling bend 30° for magnet attachment
- 8 HaloX® 180 for precast concrete for magnet attachment
- 9 HaloX® 180 / 250 for precast concrete for magnet attachment
- 10 HaloX® 180 with tunnel for precast concrete for magnet attachment
- 11 Universal installation housing with mineral fibreboard
- 12 One-gang junction box without plaster skin with 48.5 mm depth

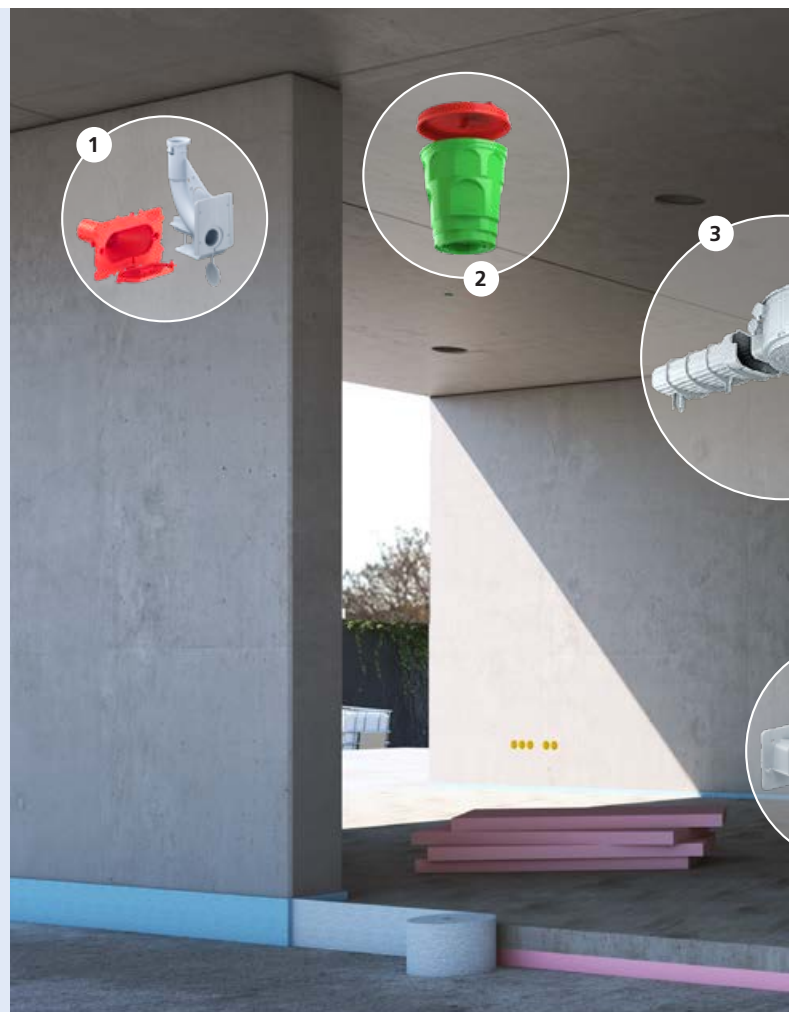

Find out more about the
precast concrete solution area.
Scan QR code or visit:
www.kaiser-elektro.org/de98





NEW

Simple and efficient concrete construction.

System magnet and system magnet PLUS.

The system magnets are suitable for all installation parts required in wall and ceiling production to prepare the electrical installation in-factory. The system magnets can be used for correct positioning in both manual and automated production. In automated production, the magnets can be placed on the formwork table by machine and in the correct position using the multifunction gripper. The system magnet PLUS (1299-70) can also be automatically removed and magazined.

The high adhesive force of 500 N ensures that the magnets remain exactly where the installation parts have been placed in their correct position.

Installation parts, such as one-gang boxes and one-gang junction boxes, are aligned via lateral notches on the system magnets and system magnets PLUS. This ensures that the vertical and horizontal alignment is dimensionally accurate, even when multiple combinations are used. The precisely fitting connection between the system magnets / system magnets PLUS and the installation parts with surrounding seal ensures that the ingress of concrete is prevented.

After removal of the formwork, the magnets remain on the formwork table and can then be returned to production.

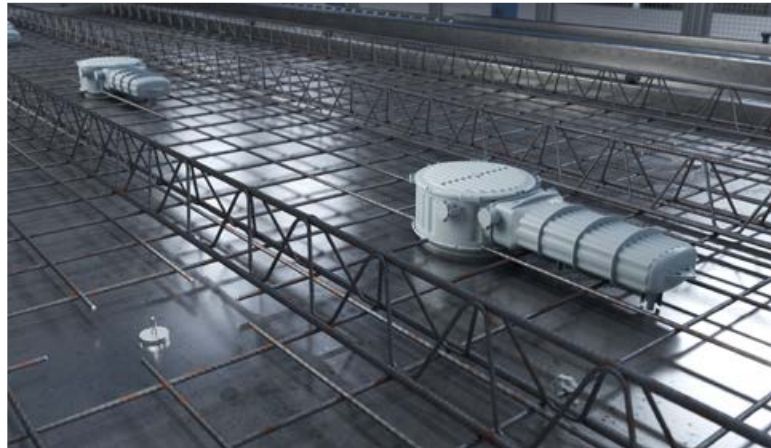
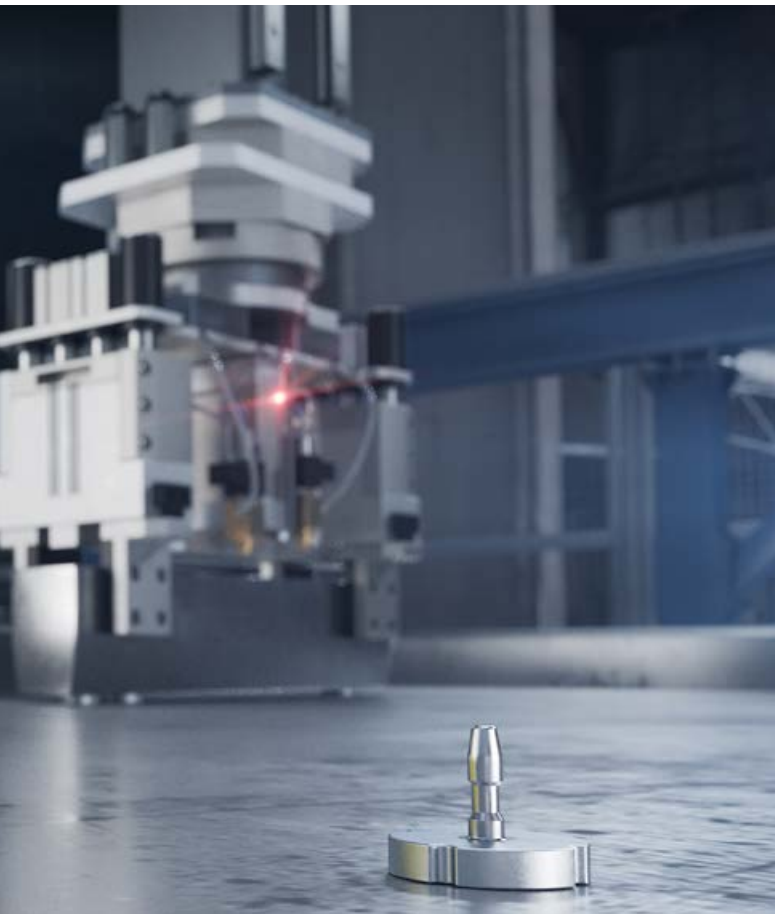

The **system magnet** and **system magnet PLUS** are used to hold B² one-gang boxes and one-gang junction boxes, large slab ceiling boxes, wall and ceiling transitions, and HaloX[®] luminaire and loudspeaker housings.



System magnet
Art. No. 1299-69



System magnet PLUS
Art. No. 1299-70

- The complete installation requires only one type of magnet.
- For automated setting (system magnet Art. No. 1299-69) or setting and removal (system magnet PLUS Art. No. 1299-70)
- Four sideway notches ensure torsion-proof installation of the one-gang boxes
- Adhesive force of 500 N
- Reusable



Precast concrete: B² wall installation.

The **B² concrete construction system** was specially developed for the requirements of production in horizontal steel formwork. B² is designed to be simple and practice-oriented so that it saves both time and money.

With B² almost every imaginable combination can be realized with the help of the individual components. This allows you to accommodate any wall thickness - in 5 or 10 mm increments - and insert the one-gang junction boxes with a perfect fit. Even single boxes that are to be installed on top of the formwork table can be positioned in a stable and torsion-proof manner with the aid of the extension elements and the abutment. Using distance piece 142 (Art. No 1261-18), combinations for the separate covering of different voltage types or to avoid wall weakening can be realised by a recessed installation (e.g. for sound, stability or fire protection reasons).



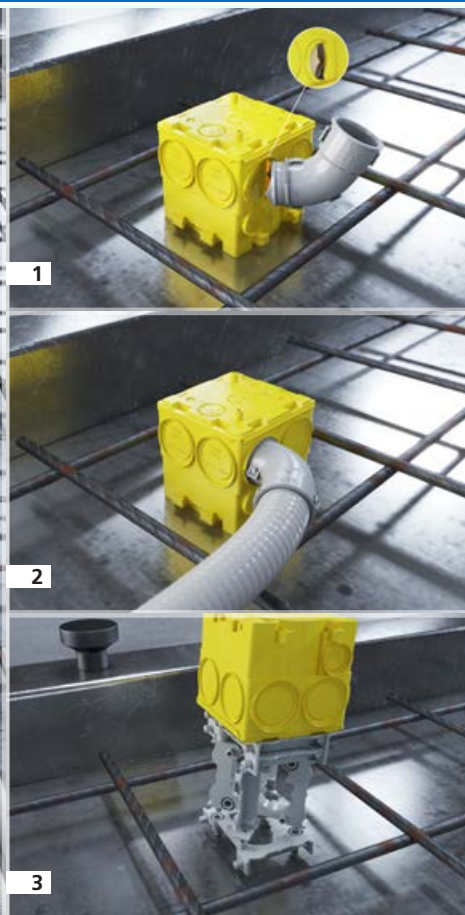

B² system for installation in horizontal precast concrete. All installation requirements can be met with just a few components. The one-gang junction boxes are adhesive and the accessories provide a practice-oriented product range.

- 1 Conduit connectors can be attached by simply locking them in.
- 2 Conduits are inserted into the locked-in conduit connector.
- 3 Extension elements are used to bridge the wall thickness and support one-gang boxes when installed on the opposing formwork.



Product video

B² one-gang junction boxes with recess

Art. No. 1262-06 / 1263-06 / 1264-06

NEW

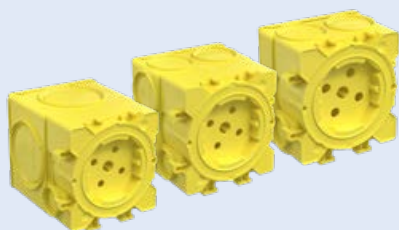

B² one-gang junction boxes with plaster skin

Art. No. 1262-60 / 1263-60 / 1264-60



B² one-gang junction boxes without plaster skin

Art. No. 1262-61 / 1263-61 / 1264-61

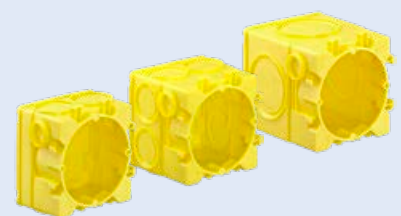

Conduit connector
Art. No. 1261-20/25/32/40



Extension element 10 to 50 mm
Art. No. 1261-10



Conduit connector 60°
Art. No. 1266-25

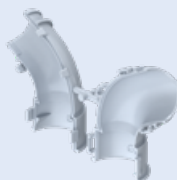

System magnet
Art. No. 1299-69

NEW



System magnet PLUS
Art. No. 1299-70

NEW



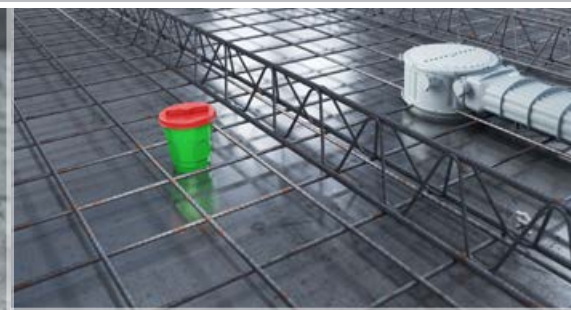

Slab ceiling boxes.

NEW

The **large slab ceiling box 115** is suitable for in-factory installation in prefabricated ceilings. The version with a slot for the system magnets (Art.-Nr. 1299-69) or system magnet PLUS (Art. No. 1299-70) is perfect for quick attachment to system magnets that have already been set automatically. The large slab ceiling boxes are already a part of the ceiling when they reach the construction site and enable the quick insertion of empty conduits. The resealable quick-release cover can be opened with a quarter turn and so enables the quick and exact creation of conduit entries using punch pliers (Art. No. 1286-33/-34).

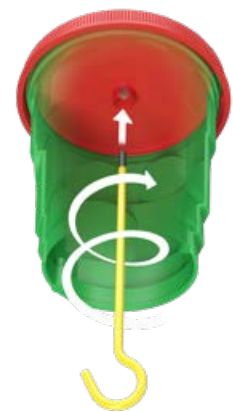

System magnet
Art. No. 1299-69



System magnet PLUS
Art. No. 1299-70

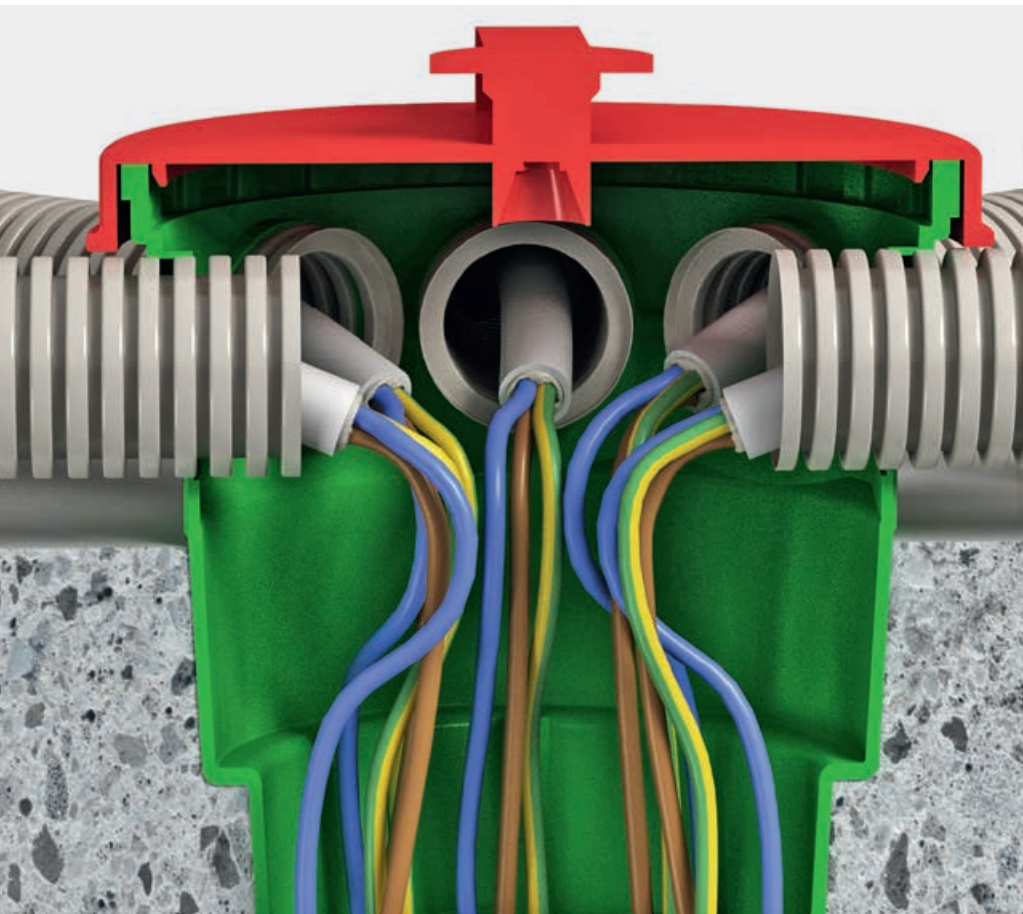

Large slab ceiling boxes are already a part of the ceiling when they reach the construction site and enable the quick insertion of empty conduits.

- 1 The conduits are installed at the construction site.
- 2 Slab ceiling boxes are easily opened with KAISER punch pliers.
- 3 The conduit is inserted tightly and accurately and the box is sealed with the cover.

Large slab ceiling boxes were specially designed for industrial manufacturing. With two different installation heights of 105 and 115 mm, they are precisely tailored to the requirements of factory installation and the different heights of the lattice girders and/or designed for maximum installation space. The boxes are secured and molded on the formwork table with hot adhesive or double-sided adhesive foils in the concrete plant. The conduits are installed after the slab ceiling elements are laid by crane at the construction site. To do so, the box screw-on covers are removed so that KAISER punch pliers can be used to make exact openings in the upper part of the box for the conduit and then the conduit is connected to the box. This can be done even if an installation box was not inserted during industrial production or when additional installation boxes are desired later on. The slab ceiling box for subsequent installation can be retrofitted into a cut drilling hole of Ø 65 mm in the prefabricated ceiling.

Large slab ceiling box 105
Art. No. 1227-54



Large slab ceiling box 115
Art. No. 1227-16



NEW **Large slab ceiling box 115**
Art. No. 1227-55



Slab ceiling box for retrofitting
Art. No. 1247-01



Light hook
Art. No. 1226-97 / 1226-98 / 1226-99



105 mm 115 mm 125 mm



Wall and ceiling transitions.

NEW

For the first time, the new end and transition bushes as well as wall and ceiling transitions 30° allow the automated positioning and fastening of conduit connections in precast concrete elements. The integrated slot for the system magnets (Art. No. 1299-69) and system magnet PLUS (Art. No. 1299-70) enables a safe, formwork-flush fit on the horizontal steel formwork for the circulation systems used in the concrete plants. The new articles also provide alternative options for fixing to formwork. They can be fixed using hot glue, steel nails and even for overhead installation in solid wall elements using Prefix® Universal supports (Art. No. 1261-00).

- Slot for system magnet (Art. No. 1299-69) and system magnet PLUS (Art. No. 1299-70) for use in automated production lines
 - For conduit sizes of 20 mm, 25 mm and 32 mm diameters
- All end and transition bushes and wall and ceiling transitions 30° can be combined with each other
- Resealable closing cover to protect the empty conduit system from concrete when installed on top, during transport and when erected on site
 - Signal bristle and strong colouring for easy retrieval in the concrete surface
 - Easy cable entry due to optimal transition radius
 - 1-piece design, immediately ready for use





3



4

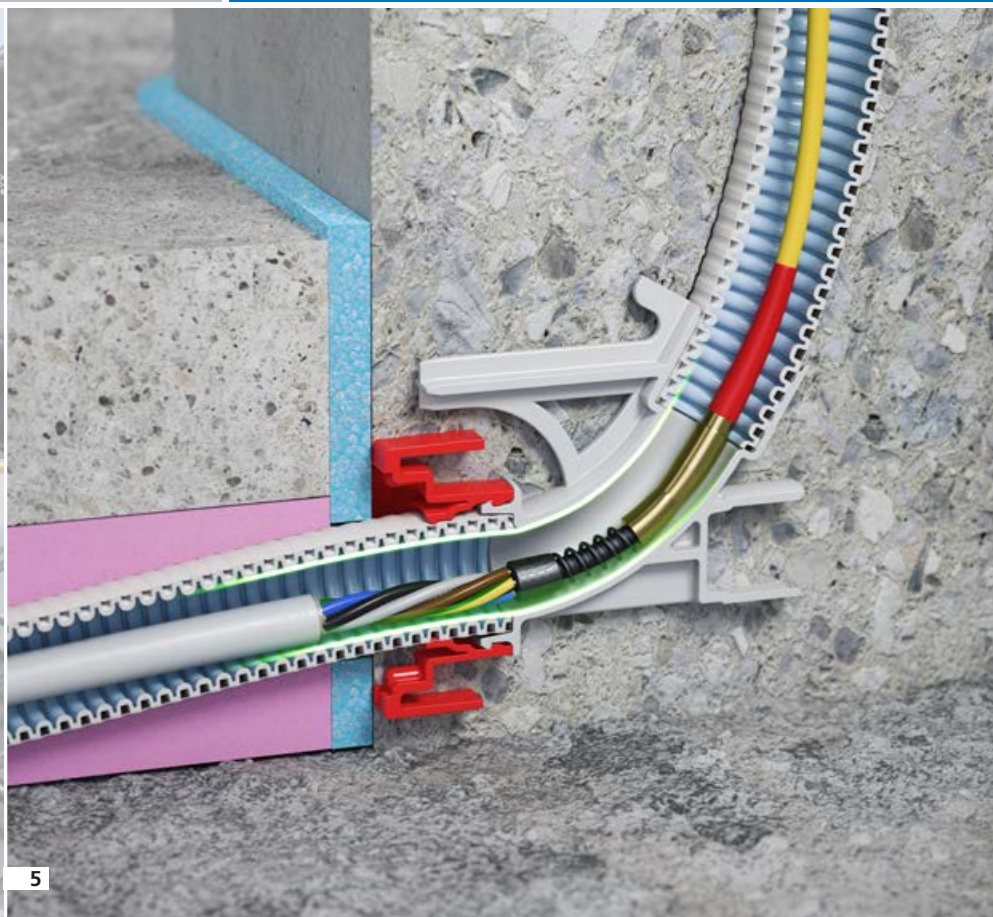

5

- 1 Wall and ceiling transitions with slot for the KAISER system magnet (Art. No. 1299-69) and system magnet PLUS (Art. No. 1299-70).
- 2 Perfect connections for automated production.
- 3 Wall and ceiling transitions for fixing by means of hot glue.

- 4 Prefix® universal support (Art. No. 1261-00, page 35) - Simple and fast processing for overhead installations.
- 5 The optimal elbow radius of the new unit facilitates flexible and easy cable insertion.

End and transition bushes, Ø 20/25/32 mm
Art. No. 1261-82/-83/-84



Wall and ceiling transition 30°, Ø 20/25/32 mm
Art. No. 1261-92/-93/-94

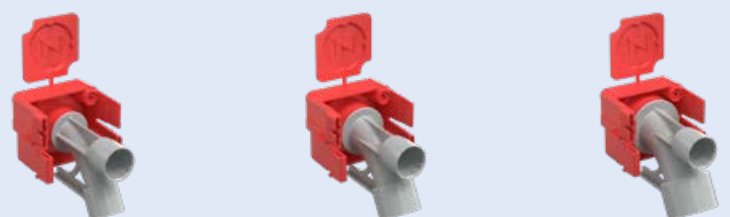

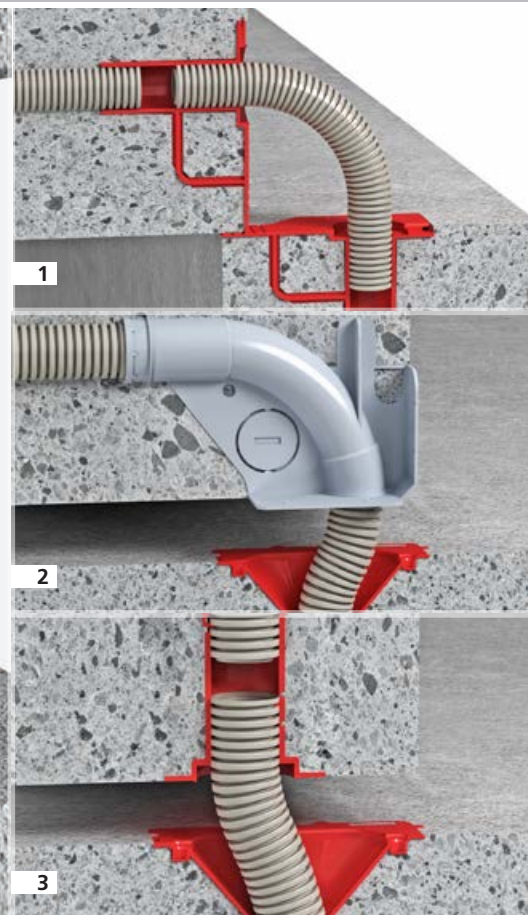
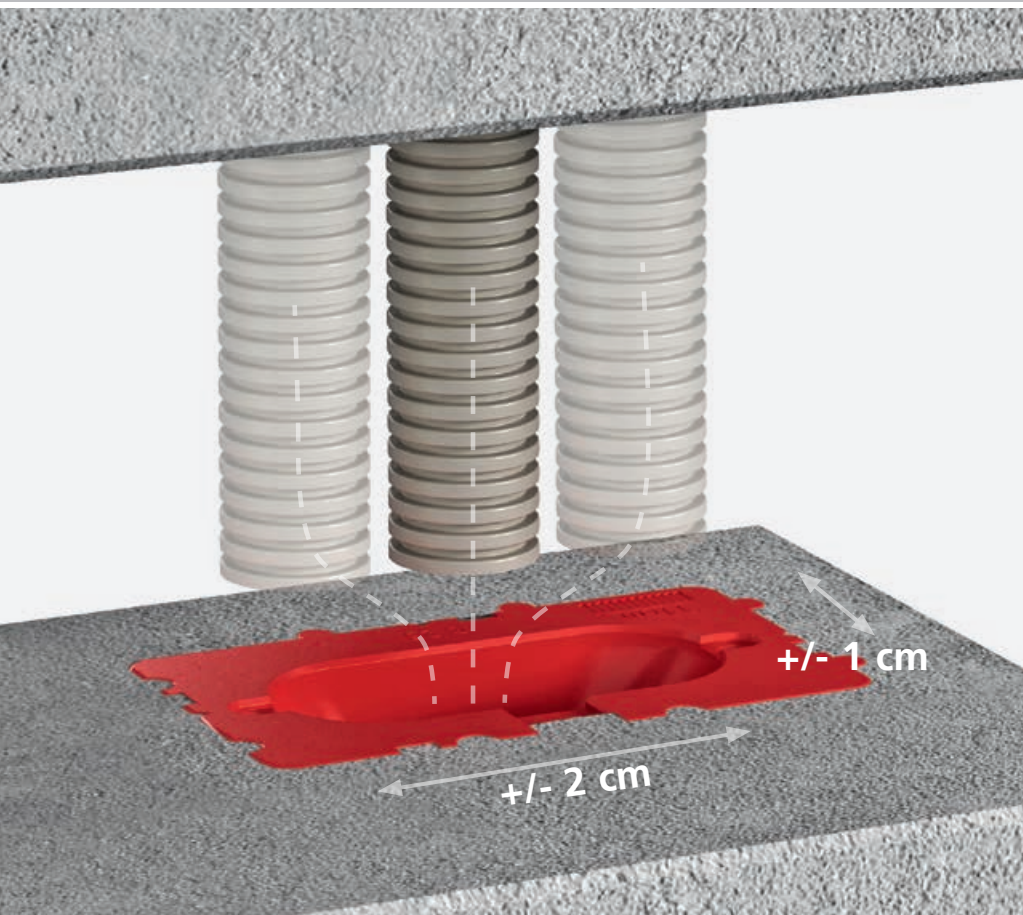

With the help of the oval funnel, a tolerance compensation of 2 or 1 cm is possible. The secure conduit entry is thus maintained.

- 1 Wall to ceiling transitions serve as wall exits or as connecting elements between prefabricated concrete elements.
- 2 The 90° wall to ceiling transition is ideal for slab ceilings.
- 3 Tolerance compensation of 2 or 1 cm possible.

Transitions for precast concrete.

KAISER offers several variants for **wall and ceiling transitions**. The 90° bend makes it easier to pull in the cables and is suitable for exits above the plain concrete ceiling or for suspended ceilings. Due to its design height, the 90° wall to ceiling transition is ideal for slab ceilings. The straight variant has an integrated measurement strip. The required distance to the formwork can be fixed in increments of 5 mm. The 90° wall to ceiling transition is available for Ø 20 and Ø 25 mm conduits, the straight version for Ø 25 mm conduits with protective covers and with or without adhesive.

The oval funnel simplifies the assembly of individual prefabricated parts. It offers a tolerance compensation of 2 or 1 cm and ensures secure conduit entry for M20 and M25 conduits. On steel formwork, the oval funnel can be fixed with hot glue and, on wooden formwork, it can be fixed to the auxiliary formwork or perimeter formwork with nails or wood screws. During installation, the oval opening is closed with a hinged cover to prevent concrete from flowing in during pouring.

Wall to ceiling transition
Art. No. 1261-12/73



Wall to ceiling transition 90°
Art. No. 1261-16 / 1261-14



Oval funnel
Art. No. 1261-42 / 1261-43



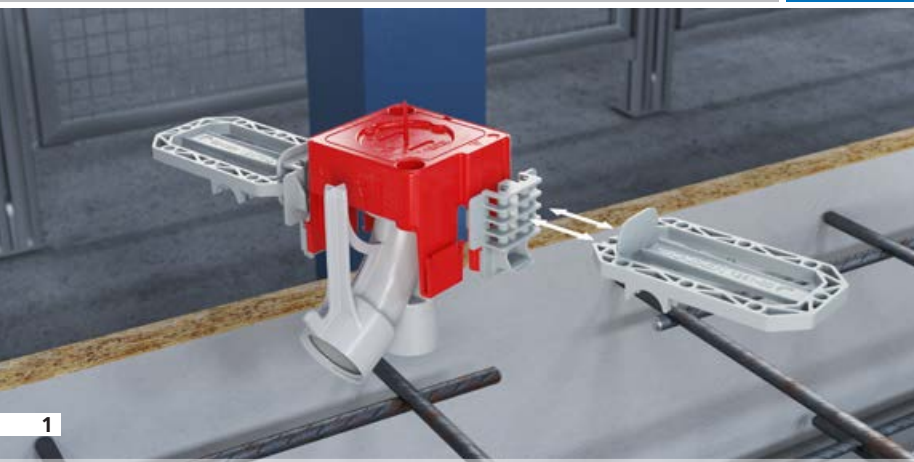

1

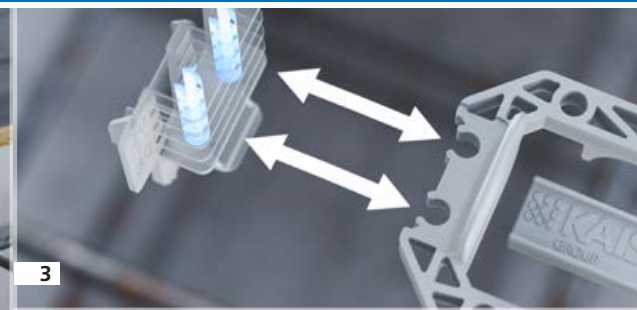

3

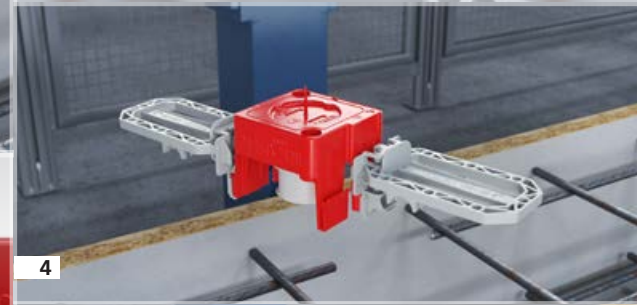

4

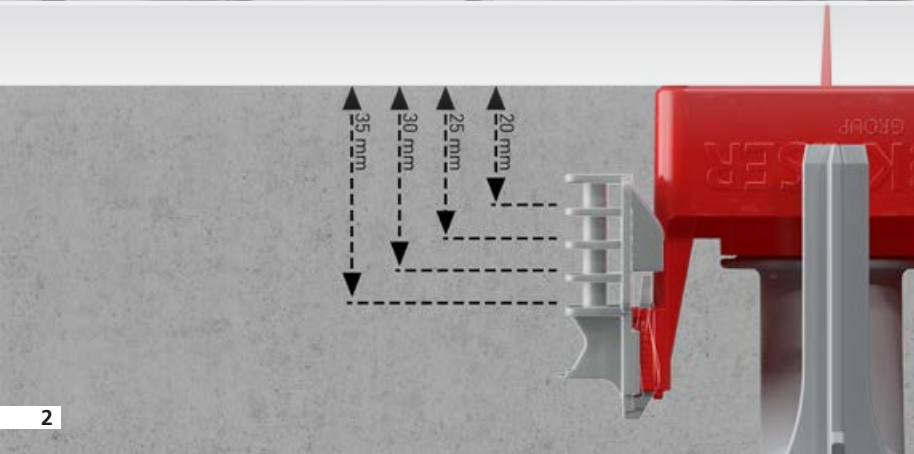

2

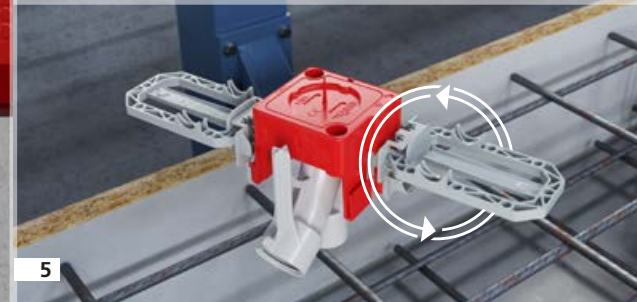

5

- 1 The new wall and ceiling transitions each have two opposing stable slots for the new Prefix® universal support.
- 2 The required concrete ceiling can be quickly read off and precisely set using the dimensional scale.

- 3 The supports have a stable snap-in connection. If the concrete cover is set incorrectly, these can be loosened again and repositioned.
- 4 With the Prefix® universal support allows all end and transition bushes ...
- 5 ... as well as the wall and ceiling transitions 30° to be installed without support on top.

The Prefix® universal support.

Solutions for a simplified opposing installation.

NEW

The Prefix® universal support enables simple, fast fitting of electrical installations in solid wall elements on the opposing formwork side without a support element for the steel formwork table. The support can be easily adjusted to the required concrete ceiling by means of a snap-in connection and attached to the new end and transition bushes and wall and ceiling transitions 30° by means of a snap-in connection. The previously customary and costly in-house constructions using timber blanks can thus be dispensed with, disruptions to the further production process are a thing of the past and production of a good wall surface quality is guaranteed without restriction.

- For opposing electrical installations in prefabricated solid walls without support elements
- With integrated dimension indication, easily adjustable to the common concrete ceilings 20 mm, 25 mm, 30 mm or 35 mm
- Generous tolerance compensation for fixing to the reinforcement
- Prefixing using Prefix® installation technology leaves both hands free for fixing with tie wires

Prefix® universal support
Art. No. 1261-00

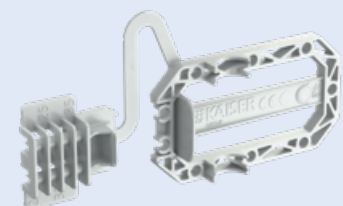

HaloX[®] system.

For precast and on-site mixed concrete.

Pressure-resistant tunnel to accommodate operating devices. Minimal effect on the statics – no cuts to the reinforcement required in the tunnel area.

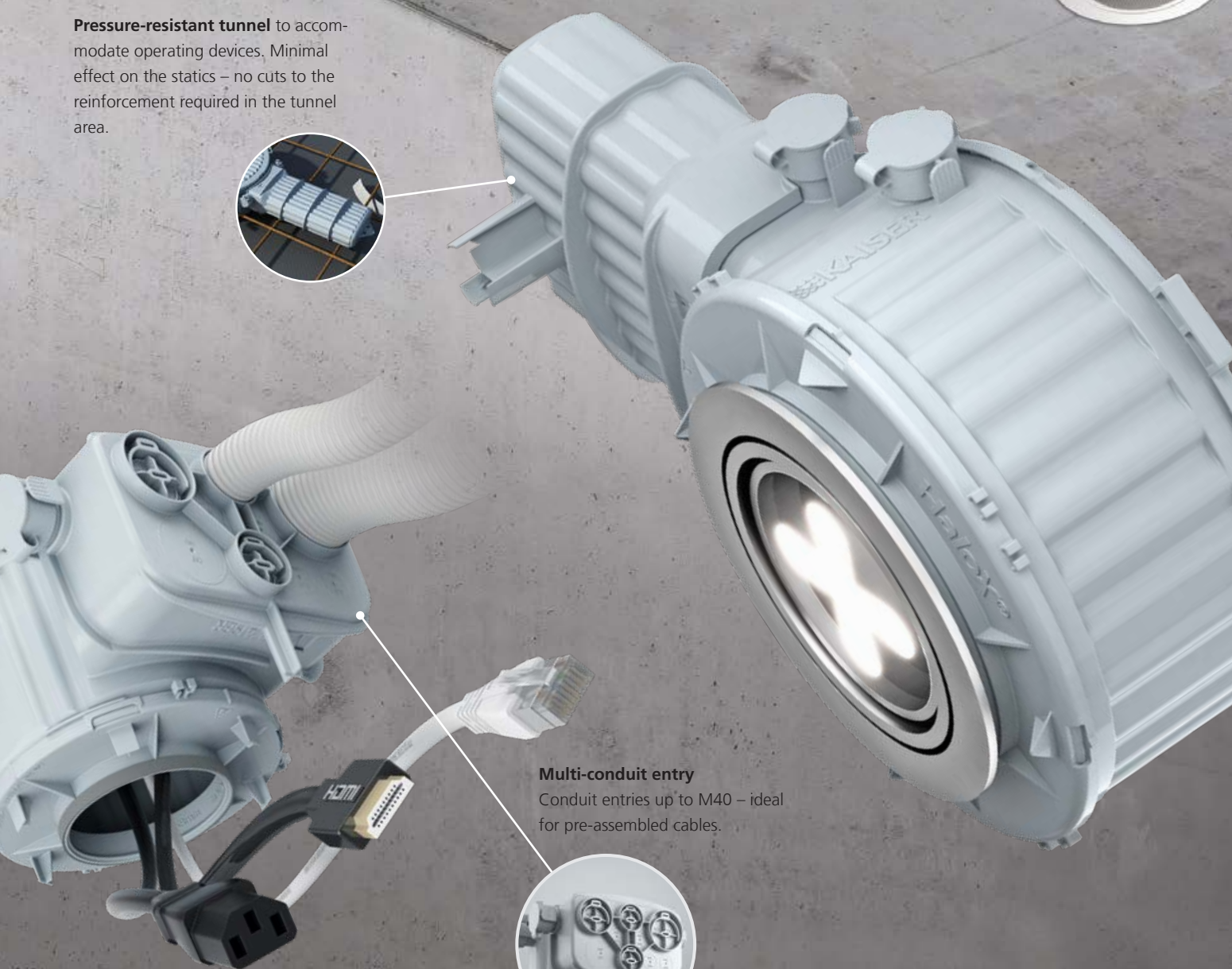

Multi-conduit entry
Conduit entries up to M40 – ideal for pre-assembled cables.



Continuous housing system – modular, flexible for all installation diameters, heights and installation openings of luminaires and loudspeakers up to a 250 mm diameter.



Combination entry for conduits M20/ M25 – toolless opening technology with secure conduit retention. Resealable for installation changes.



Wave-shaped surface profile ensures maximum housing surface for optimum heat dissipation via the concrete.



Shape-retaining and resilient.

Compact housing with stabilizing wave profile provides the necessary stability during the concreting process – even under extreme loads.



For ceiling and wall installation.



Easy to find after stripping -
Signal cover.





1



2



3



4

There are many types of luminaires and loudspeakers. HaloX® fits them all.

The new generation of concrete installation housing offers secure installation space for loudspeakers and luminaires with LED, halogen or compact fluorescent lights and their operating devices in ceilings and in walls. HaloX® creates the space required for modern lighting and sound solutions. Due to its modular and flexible structure, the system offers a solution for virtually all installation diameters and installation depths.

Choosing the appropriate housings and accessories is extremely simple. The HaloX® housing system is available in three basic types - HaloX® 100, HaloX® 180 and HaloX® 250 - together with a tunnel for the secure fastening of operating devices (e.g. LED drivers).

- 1 HaloX® system 100 with multi-conduit entry
- 2 HaloX® system 180 with tunnel 190
- 3 HaloX® system 250 with tunnel 325
- 4 HaloX® creates a secure installation compartment for luminaires and loudspeakers in concrete ceilings and walls

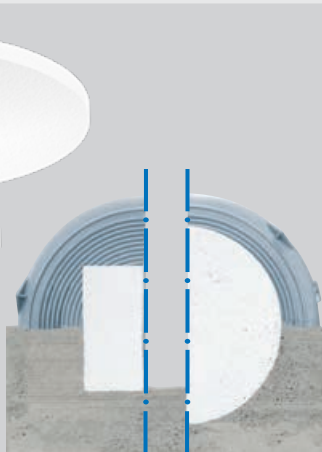
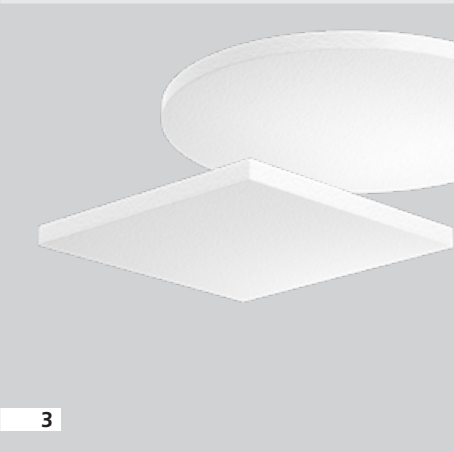
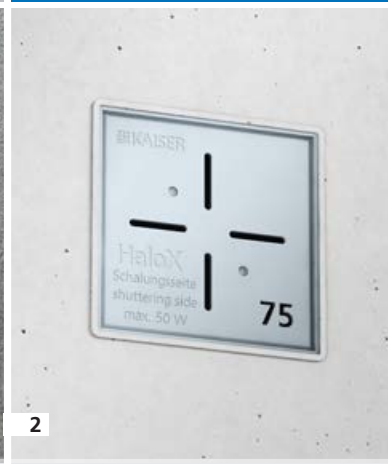

Forms and functions.

Front sections with defined installation diameters are available for all enclosure sizes - also for the facing concrete versions. An additional elastomer sheathing prevents the dry concrete from cracking in this case. Styrofoam moulded parts are available for individual installation diameters in almost any shape and thickness, and universal front parts are suitable for variable or as-yet-undefined ceiling exits.

- 1 Round front parts with and without an elastomer seal.
- 2 Square front parts with and without an elastomer seal.
- 3 Styrofoam moldings for individual cut-outs in any shape and size (with and without an elastomer seal).
- 4 Universal front parts for variable or not yet defined ceiling cut-outs.

HaloX® 100/180/250 front parts
1281-01..07
1282-01..06
1283-01..06



HaloX® 100 front parts, square
1281-08/09



HaloX® 100/180/250 front parts for facing concrete
1281-61..67
1282-61..66
1283-61..66



HaloX® 100 front parts, square for facing concrete
1281-68/69

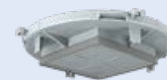

HaloX® 100/180/250 universal front parts with plastic panels
1281-10
1282-10
1283-10



HaloX® 100/180/250 universal front parts with mineral fibreboard
1281-11
1282-11
1283-11



HaloX® Styrofoam moulded parts
1292-90



Processing of on-site mixed concrete.

The shape-retaining HaloX® system has a modular design for processing of on-site mixed concrete. Three housing diameters with a large number of round and square and universal front parts make possible integration of all built-in luminaires with LED, halogen or compact fluorescent lamps and loudspeakers up to a ceiling exit of 250 mm, including in facing concrete. With a tunnel, the system provides sufficient space to house operating devices such as LED drivers. Optional extension rings to increase the installation depth.

All front parts are moisture-repellent and can be positioned exactly and nailed-on even before the first reinforcement is laid. Housings and front parts are firmly and stably latched together and can still be aligned as required afterwards.

After casting, front parts with a defined installation diameter can be opened with a targeted hammer blow. The front parts for universal opening sizes can be plastered locally or plastered over. The desired installation opening is then created with conventional milling tools such as the Multi 4000.

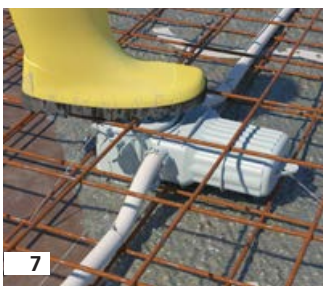
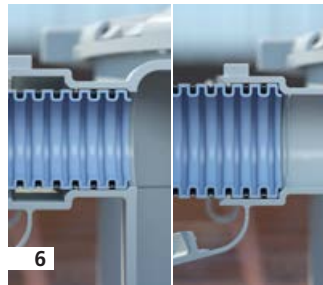
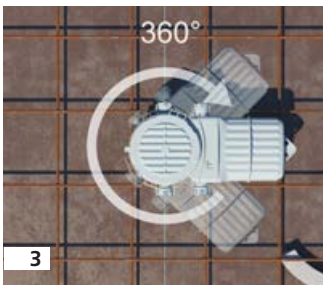
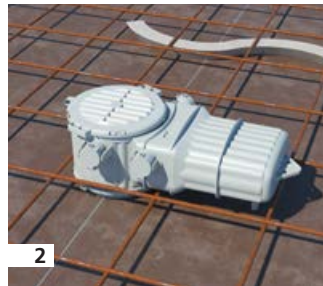
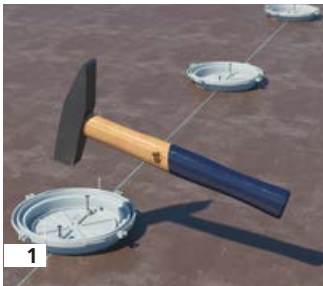

Installation on the ceiling formwork

- 1 The shallow front part (20 mm) lies below the lower reinforcement layer, thus not hindering any subsequent works, and can be precisely aligned using the centre marking.
- 2 After inserting the reinforcement, the required reinforcement cuts can be made and the casings can be latched to the front parts.
- 3 After locking the casing, it can be rotated 360° for better conduit connection or to avoid collisions with the reinforcement.
- 4 The combination conduit entry can easily be opened by hand. If necessary, conduit entries that have already been opened can simply be closed again.
- 5 The combination conduit entry provides a secure connection for both jacketed and non-jacketed pipes ...
- 6 ... and can be used individually for conduit sizes of 20 mm or 25 mm diameter. It offers a high degree of pull-out safety and, thanks to the integrated depth stop, makes subsequent internal shortening of the conduits superfluous.
- 7 All HaloX® installation housings are robustly designed and meet the requirements of the harsh conditions at the construction site and in the concrete factory.
- 8 After formwork removal, the HaloX® system ensures a clean ceiling appearance and the optimum condition for installing luminaires and loudspeakers.



Product film

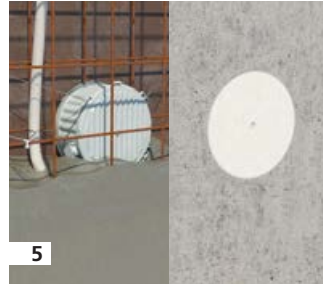

Wall installation, installation on the working formwork

- 1 Thanks to the stable nail domes arranged in the plaster skin and the centre marking on the side, the front parts can be precisely aligned and securely fixed.
- 2 After inserting the reinforcement, the required reinforcement cuts can be made and the casings can be latched to the front parts. In the case of housings with a tunnel, this must be aligned vertically downwards.
- 3 When using HaloX® 180 or HaloX® 250, the wall installation kit (Art. No. 1299-xx) must be used for additional stabilisation of the housings.
- 4 To further secure the HaloX® housing, this can be additionally fixed to the reinforcement by means of tie wires through the tie lugs.
- 5 After formwork removal, the HaloX® system ensures a clean wall appearance and the optimum condition for installing luminaires and loudspeakers.
- 6 The wall installation kit (Art. No. 1299-xx) must be used for wall installation of the HaloX® 180 or HaloX® 250 housings. This ensures a maximum installation compartment even with high concrete pressure.

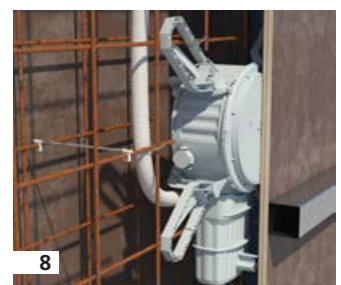
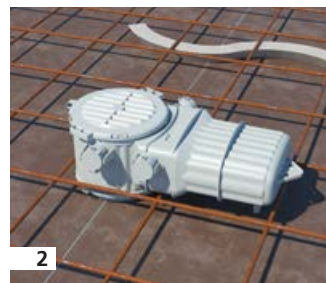
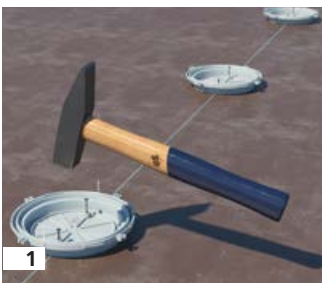

Wall mounting, mounting to opposing formwork by means of Prefix® installation set

- 1 Prefix® installation sets (Art. No. 1299-65) for HaloX® 100 and for HaloX® 180/250 (Art. No. 1299-66) are available as an option for mounting to the opposing formwork.
- 2 When mounting HaloX® 180/250, also use the wall installation kit (Art. No. 1299-60).
- 3 The Prefix® installation clamps can be latched-on on both sides and are suitable for concrete covers measuring 20 - 40 mm...
- 4 ...and 40-60 mm.
- 5 Following pre-fixing by using Prefix® installation clamps, both your hands are free to carry out fast, secure fixing to the reinforcement using tie wires.
- 6 Now the housing can be populated with 20/25-mm diameter conduits without using tools.
- 7 Concrete cover after installation with catch mechanism Prefix® installation clamps for 20-40 mm concrete covering.
- 8 Concrete cover after installation with catch mechanism Prefix® installation clamps for 40-60 mm concrete covering.

Extension rings

To enlarge the installation compartment.



HaloX® 100: front side extension 10, 25 or 50 mm (Art. No. 1281-21, -25, -50).



HaloX® Ø 180: front-side extension 25 or 50 mm (Art. No. 1282-25, -50)



HaloX® Ø 180: rear-side extension 25 or 50 mm (Art. No. 1282-25, -50)



HaloX® Ø 250: extension 25 or 50 mm front or rear (Art. No. 1283-25, -50)



1



2



3



4



5



6



7

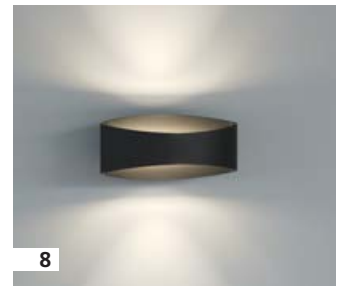

8

Electrical installation (after formwork removal)

- 1 After formwork removal, the front part (e.g. Art. No. 1281-01) can be opened with a blow of the hammer.
- 2 The optimal foundation for modern ceiling lighting.
- 3 With KAISER MULTI 4000 turbo cutters (e.g. Art. No. 1083-10), the required installation openings can be created easily and precisely in universal plastic front parts (e.g. Art. No. 1281-10).
- 4 Design freedom for creative, modern lighting systems.
- 5 With the KAISER VARIOCUT (e.g. Art. No. 1089-00), the required installation openings can be made with millimetre precision in the universal mineral fibre front parts (e.g. Art. No. 1281-11).
- 6 Optimal sound volume for modern multi-room systems.
- 7 Individual opening dimensions (e.g. rectangular cut-outs) can be made in the universal front parts as required using a commercially available jigsaw.
- 8 The perfect installation compartment for individual orientation lighting.



Product film

System overview: HaloX® 100, HaloX® 180 and HaloX® 250 for on-site mixed concrete

The HaloX® system for on-site mixed concrete consists of different components, which are put together individually depending on the use. Follow the steps below to choose the required components:

1 Installation space for luminaires/loudspeakers and operating devices

without additional space for operating devices



Additional space for operating devices



up to 150 x 90 x 50 mm

Additional space for larger operating devices



up to 280 x 90 x 50 mm

Exit for pre-assembled cables

Conduits up to M40



max. 100 mm

HaloX® 100
1281-00



HaloX® 100
with tunnel 190
1281-30

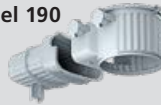

HaloX® 100
multi-conduit
entry
1281-15



max. 180 mm

HaloX® 180
1282-00



HaloX® 180
with tunnel 190
1282-30



HaloX® 180
with tunnel 325
1282-40



max. 250 mm

HaloX® 250
1283-00



HaloX® 250
with tunnel 325
1283-40



* the max. dimensions for operating devices must be checked in relation to the installation opening

2 Luminaire/loudspeaker installation diameters



round

- Front parts round
- Front parts round (facing concrete)

Ø 68 - 100 mm



square

- Front parts square
- Front parts square (facing concrete)

68x68 - 75x75 mm



universal

- Universal front part plastic (a)
- or mineral fibreboard (b)

Ø max. 100 mm

specific

individual Styrofoam moulded parts
(optional for facing concrete)

•

Ø 100 - 180 mm

-

Ø max. 180 mm

•

Ø 180 - 250 mm

-

Ø max. 250 mm

•

3 Installation depth



Installation
height
> 110 mm



Extension rings
10/25/50 mm
1281-21/25/50



Extension rings
25/50 mm
1282-25/50



Extension rings
25/50 mm
1283-25/50

4 Accessories



Wall installation in
vertical formwork



Prefix® installation set
for fixing to the rein-
forcement
1299-65

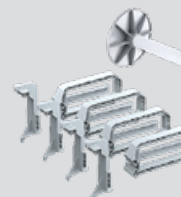

Wall installation kit for installa-
tion in vertical formwork
1299-60...64

Prefix® installation kit for
fixing to the
reinforcement
1299-66

Easy to find after
formwork removal



Signal cover
1281-31...33



Signal cover. The solution for a clean ceiling appearance after plastering.

NEW

The new signal cover ensures a clean ceiling appearance and avoids time-consuming reworking of the installation opening after plastering. As an accessory item for the KAISER HaloX® concrete installation housings, the signal cover is simply inserted into the already opened front part after formwork removal from the rough ceiling or wall. Thus, the installation opening is securely closed and protected against penetration of plaster. Three signal bristles, in combination with the bright red colour, ensure that the installation opening in the plastered rough ceiling or wall can be found quickly and easily. The installation opening can be opened with one targeted blow of the hammer without destroying the surrounding plaster pattern. With one turn of the knife edge, cleaning residues are removed effortlessly. The flexible signal cover can then be removed easily and cleanly. Its specially serrated edge structure preserves the plaster edge.

- Stable and robust clamping in installation diameters of 68 mm, 75 mm and 80 mm,
- For use in fixed HaloX® front parts, universal HaloX® front parts and other installation openings
- Stable signal bristles and strong colouring for easy retrieval from the plaster surface
- Reusable, easy to clean





1

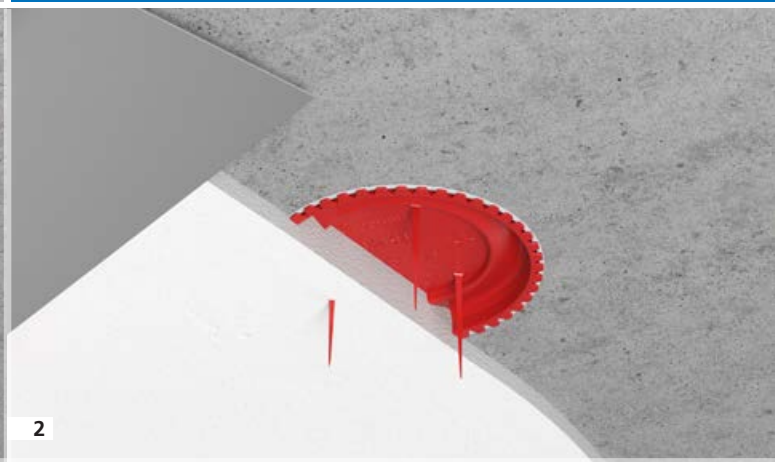

2

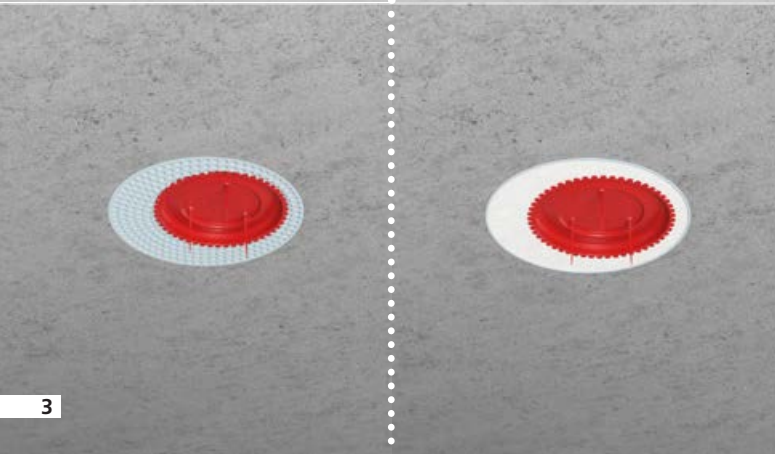

3



4

- 1 After formwork removal and pull-in of the supply conduits, the signal cover is inserted into the installation opening.
- 2 The red signal bristles are flexible during the smoothing process and do not hinder this work step but, at the same time, are stable enough to keep the position in the plaster surface recognisable.

- 3 In addition to being able to use the HaloX® front parts with fixed exit opening, these can also be inserted into the universal HaloX® front parts.
- 4 In the case of factory-fitted HaloX® housings for one of the system magnets (e.g. 1299-69 / 1299-70), the signal covers allow the recess to be smoothed or filled over the entire surface.

Signal cover

Art. No. 1281-31/ .. 32/ ..33



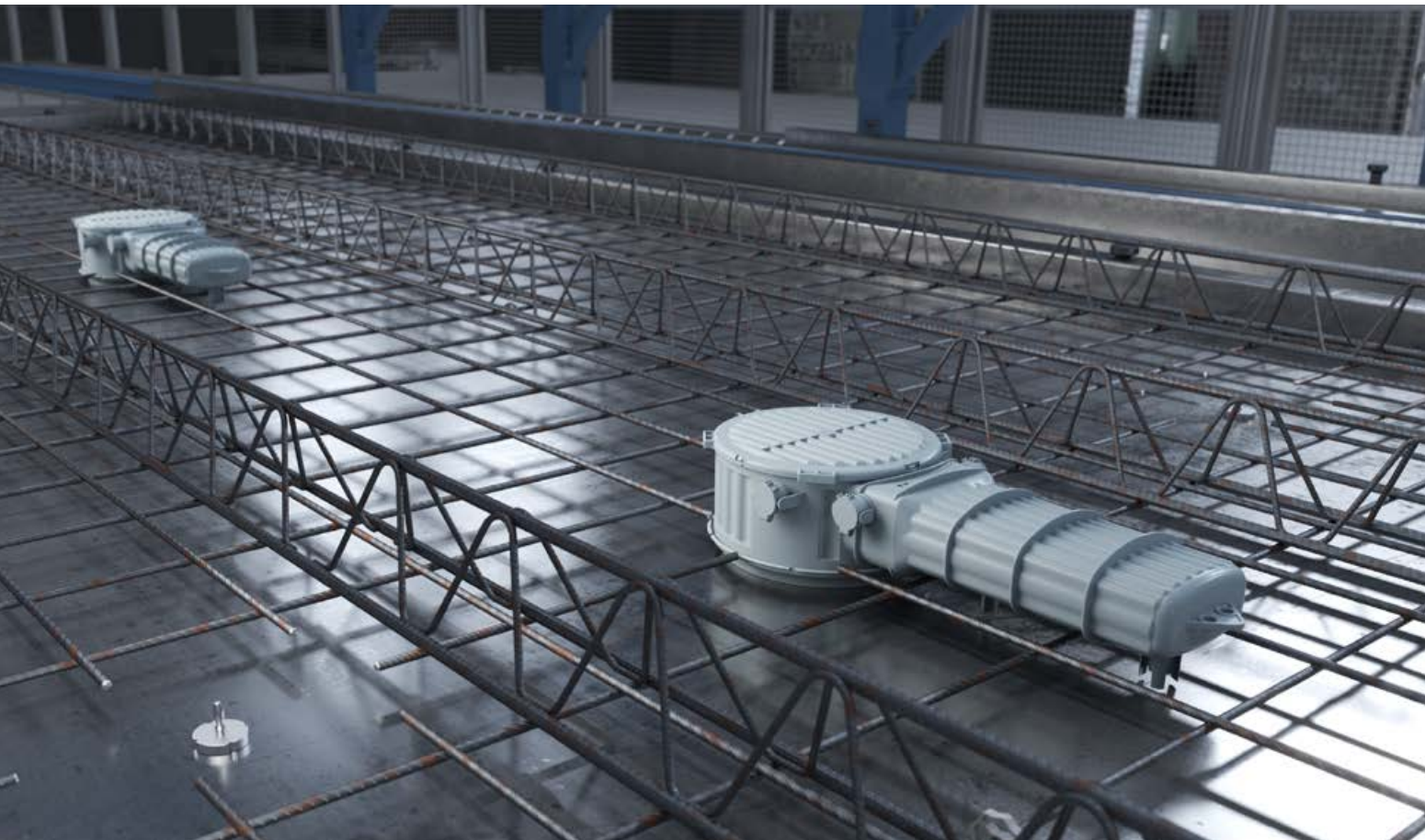

Processing in precast concrete.

The HaloX® system is designed as a single element for fitting in precast concrete. Markings on the housing facilitate alignment on the formwork table. The housing with pre-fitted mineral fibre-board allows easy glueing and the housings can be turned by 360° on the formwork table even after glueing. For the magnet attachment, enclosures are available with pre-fitted front parts to accommodate the system magnet (Art. No. 1299-69 / 1299-70). Laying tolerances which may occur during the fitting of panel elements are compensated for via the housing sizes in connection with a variable cut-out area. Because of the compact dimensions of the housings, the reinforcement can easily be placed around the housing. For luminaires or loudspeakers with installation depths equal to or greater than 110 mm, the installation compartment of the HaloX® housings can be increased on the on-site concrete building site by means of extension rings. The fitting of conduits on the on-site mixed concrete construction site is toolless for M20/M25 conduits without any internal shortening of the conduits.

HaloX® 180
Art. No. 1282-71



HaloX® 250
Art. No. 1283-71



**HaloX® 180
for magnet attachment**
Art. No. 1282-74



**HaloX® 250
for magnet attachment**
Art. No. 1283-74





1

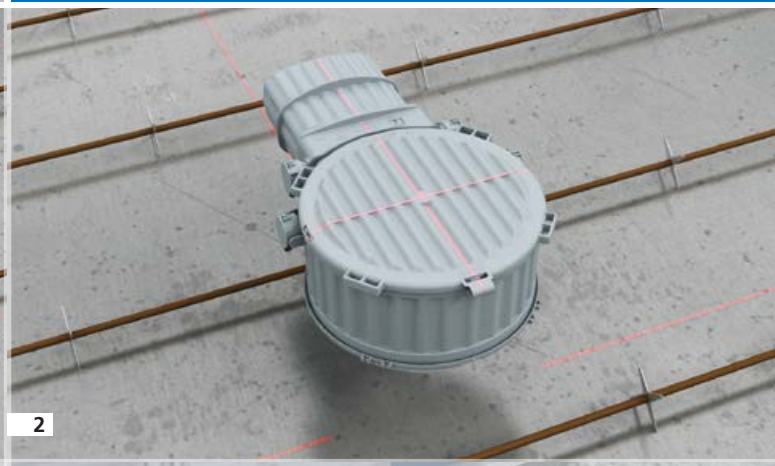

2



3



4

- 1 Mounting of the single-piece housing with mineral fibreboard.
- 2 Alignment marks for exact positioning on the formwork table.
- 3 Fitting of the one-piece housing by means of a magnet (Art No. 1299-69).
- 4 Precise and level fixing of the housing.



Product video

**HaloX® 180
with tunnel 190**
Art. No 1282-72



**HaloX® 180
with tunnel 325**
Art. No 1282-73

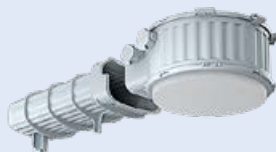

**HaloX® 250
with tunnel 325**
Art. No 1283-73



**Replacement
mineral fibre-
board
for HaloX® 180,
HaloX® 250**
Art. No 1282-27
Art. No 1283-27



**HaloX® extension
rings**
Art. No. 1282-25/50
Art. No. 1283-25/50



**HaloX® 180
with tunnel 190
for magnet attachment**
Art. No. 1282-75



**HaloX® 180
with tunnel 325
for magnet attachment**
Art. No. 1282-76



**HaloX® 250
with tunnel 325
for magnet attachment**
Art. No. 1283-76



**System magnet /
System magnet PLUS**
Art. No. 1299-69/1299-70



Signal cover
Art. No. 1281-31/..32/..33



NEW

NEW

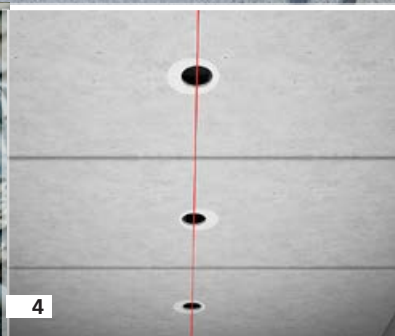
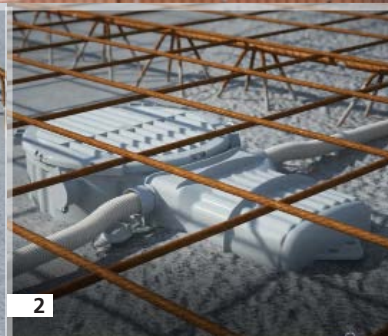

Further processing in prefabricated elements at the construction site.

Further processing of HaloX® housings is quite simple. The housing sizes in combination with the universal front parts allow the compensation of tolerances, which may arise when laying the panel elements. After laying the panel elements, the conduits can be fitted. The toolless opening of the M20/M25 combination entries enables fast and secure conduit insertion. At the same time, the depth stop obviates the need for subsequent internal shortening of the conduits.

For luminaires or speakers with greater installation depths (> 100 mm), the installation compartment of the HaloX® housing can be subsequently raised with extension rings at the on-site mixed concrete construction site.

- 1 Toolless conduit entry for M20/M25 conduits with depth stop.
- 2 Finished conduit installation of the HaloX® housing.
- 3 Increase of the installation depth by means of extension rings.
- 4 Making the ceiling cut-outs (e.g. with Art. No 1083-10) in compliance with the laying tolerance.



Product video

System overview: HaloX® 180 and HaloX® 250 for precast concrete

The HaloX® system for precast concrete consists of various elements, which are configured individually as required. Follow the steps below to choose the required components:

1 Installation compartment for luminaires/loudspeakers and operating devices



max. 140 mm
(with tolerance compensation)
max. 180 mm
(without tolerance compensation)



max. 210 mm
(with tolerance compensation)
max. 250 mm
(without tolerance compensation)

Adhesive attachment
one-piece housing with universal mineral fibre-board

Magnet attachment
one-piece housing with universal plastic panel for holding the magnet

Adhesive attachment
one-piece housing with universal mineral fibreboard

Magnet attachment
one-piece housing with universal plastic panel for holding the magnet

System magnet
1299-69
System magnet PLUS 1299-70

System magnet
1299-69
System magnet PLUS 1299-70

without additional space for operating devices



HaloX® 180
1282-71



HaloX® 180
1282-74



HaloX® 250
1283-71



HaloX® 250
1283-74

Additional space for operating devices



up to max. 150 x 90 x 50 mm



HaloX® 180 with tunnel 190
1282-72



HaloX® 180 with tunnel 190
1282-75

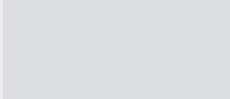

HaloX® 250 with tunnel 190
1283-73

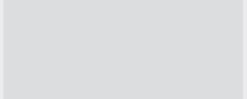

HaloX® 250 with tunnel 190
1283-76

Additional space for larger operating devices

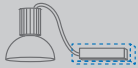

up to max. 280 x 90 x 50 mm



HaloX® 180 with tunnel 325
1282-73



HaloX® 180 with tunnel 325
1282-76



HaloX® 250 with tunnel 325
1283-73



HaloX® 250 with tunnel 325
1283-76

2 Installation depth



Installation height
> 110 mm



Extension rings
25 / 50 mm
1282-25/50



Extension rings
25 / 50 mm
1283-25/50

3 Accessories



Wall installation in vertical formwork



Wall installation kit for installation in vertical formworks
1299-60...64

Easy to find after formwork removal



Signal cover
1281-31...33

Tolerance compensation

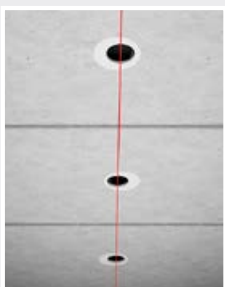

Depending on the installation diameter, inaccuracies arising during installation of the slab ceilings can subsequently be corrected. Variable installation diameters can be cut out precisely in the front parts with the KAISER VARIOCUT universal hole cutter.

HaloX® 180

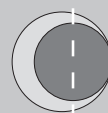

HaloX® 250

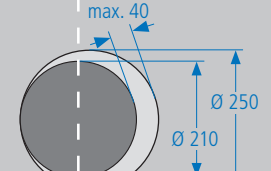
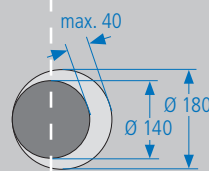



Universal installation housings for concrete ceilings and walls. Variable for various installation accessories.

Universal installation housings allow easy and secure installation of many applications for which no concrete installation solutions are commercially available. For example, accessories such as touch panels for smart home applications can be optimally installed via the installation opening that can be made in the mineral fibreboard.

Universal installation housings also provide the perfect solution for other applications used for control, lighting or sound systems of rooms and buildings.

The processing of the universal installation housings is similar to that of the junction boxes, so that both the planning and the installation can be carried out just as easily.

The housing system is equally suited for installations in on-site mixed concrete and in precast concrete elements, as well as for use in walls and ceilings, so that the system has no restrictions here either.

The universal mineral fibreboard can be easily and precisely opened for the relevant applications using a jigsaw. A peripheral groove in the mineral fibreboard determines the maximum possible cut-out.



1



2



3



4

- 1 The housing in the concrete is flush-mounted with the mineral fibreboard.
- 2 The support prevents it from being pressed inward while the concrete is being cast.
- 3 The front panels are easy to process, ensuring the ability to create flexible cut-outs.
- 4 The groove in the mineral fibreboard marks the maximum fitting area.

Universal installation housing with mineral fibreboard
Art. No. 1223-22



Universal installation housing with mineral fibreboard
Art. No. 1224-22



Universal installation housing with mineral fibreboard
Art. No. 1295-22



Universal installation housing with mineral fibreboard
Art. No. 1296-22



Universal installation housing with mineral fibreboard
Art. No. 1297-22



Universal installation housing with mineral fibreboard
Art. No. 1297-../1298-..



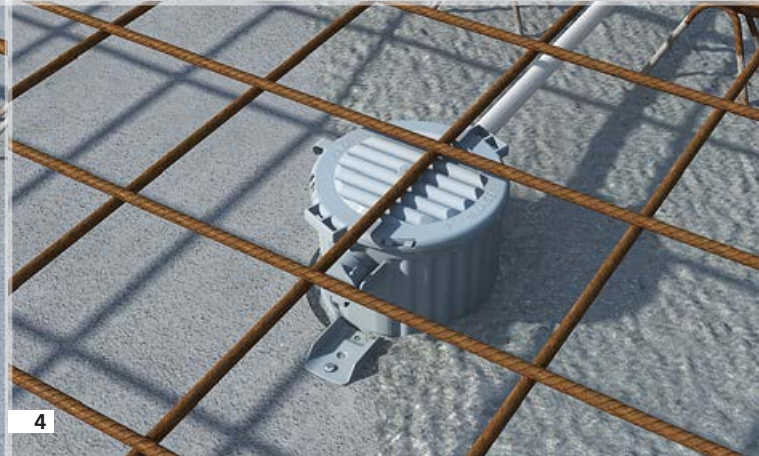

- 1 A drilling hole (\varnothing 150 - 160 mm) is cut into the slab ceiling.
- 2 Front parts and extension rings are combined according to the ceiling thickness and installation depth.
- 3 Place the housing in the drilling hole and fasten.
- 4 The housing attached to the reinforcement now sits firmly and precisely in place.

HaloX[®] installation kit.

For retrofitting in slab ceilings.

The HaloX[®] installation kit can be retrofitted in existing slab ceilings (from thickness 50 mm) with or without a transformer tunnel. Be sure to take into account the ceiling thickness and the structural alteration of the ceiling (e.g. fire protection and statics).

- For retrofitting in filigree ceilings
- Minimal effect on statics
- Enables convenient short-term planning changes
- Large selection of opening dimensions up to \varnothing 100 mm
- Extension rings for bridging the slab ceiling element and for increasing the luminaire installation depth





1

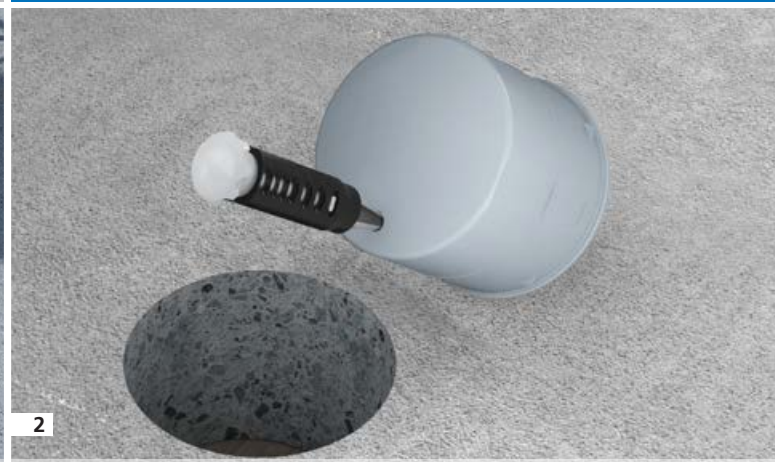

2



3



4



5

- 1 Cut drilling hole in the solid ceiling with a diameter \varnothing 150 - 160 mm.
- 2 The universal opening cutter is used to create precisely fitting conduit entries for the corresponding conduit sizes.
- 3 Front parts and extension rings are combined according to the ceiling thickness and installation depth.
- 4 The complete housing with the installed conduit is inserted into the drilling hole.
- 5 Then the free space is filled with concrete and compacted.

HaloX[®] for solid concrete ceilings. For retrofitting.

HaloX[®] concrete installation housing for solid concrete ceilings can be inserted into existing and retrofitted drilling holes.

- For retrofitting in solid ceilings
- Minimal effect on statics
- Quick installation with snap-in connections
- Robust construction, ideal for use on building sites
- Large selection of opening dimensions up to \varnothing 100 mm

HaloX[®] housing for drilling holes in solid ceilings
Art. No. 1290-30





Products for facing concrete. Highest requirements for appearance.

Facing concrete is a very popular architectural feature that is used for walls, stairs and specially-shaped elements. This is basically normal concrete. However, as the components are not processed any further after stripping the formwork, the visual appearance differs significantly from normal concrete. Facing concrete is a part of architectural and interior design, which requires very precise advance planning to achieve the desired appearance.

The electrical installation also has some extra requirements when installed in facing concrete. KAISER offers various solutions for installation in facing concrete. Innovative product properties ensure that the installed products are safely moulded in the concrete and that the equipment can be installed without any problems.



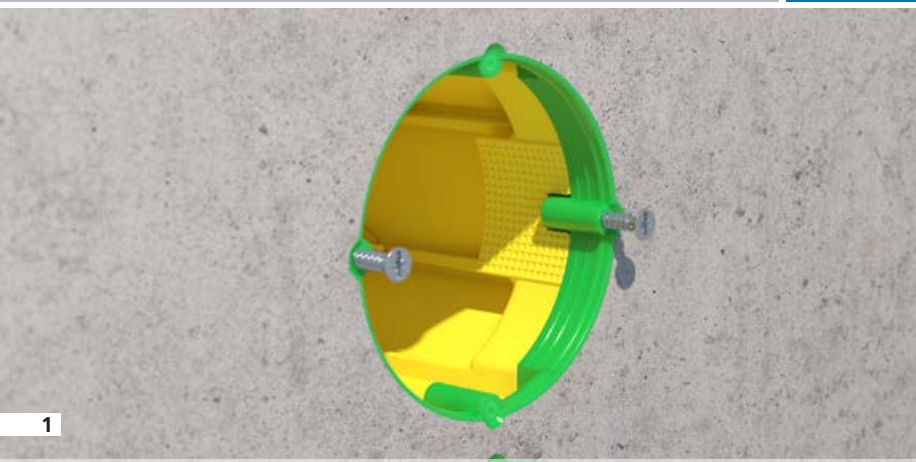

1



3

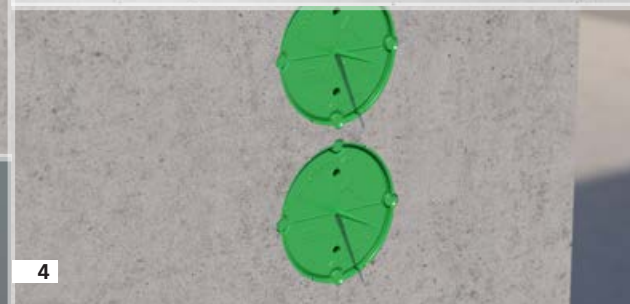

4

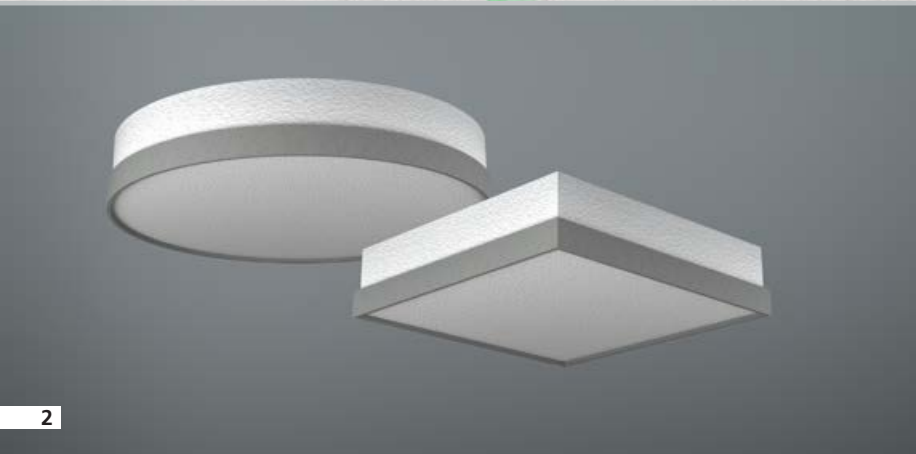

2

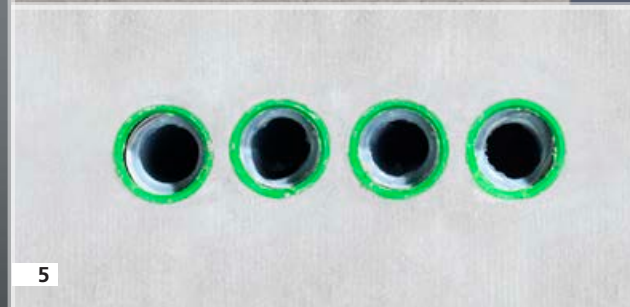

5

- 1 The products of the B' programme are suitable for use in facing concrete.
- 2 Styrofoam moulded parts with an elastomer seal for individual cuts-outs are available in any shape and size.
- 3 The HaloX® system includes a variety of front parts with elastomer seals for use in facing concrete.
- 4 Prefix® concrete building boxes also for use in facing concrete.
- 5 Wall and ceiling transitions can be used as cable exits with a minimal visible surface.

B' one-gang boxes / one-gang junction boxes / large-diameter conduit connector boxes
Art. no 1255-01 / 1265-01 / 1260-01

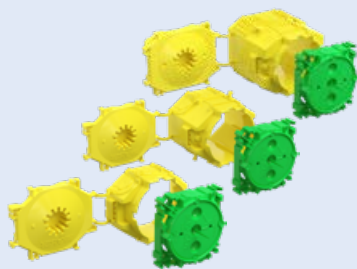

Prefix® concrete construction box 60 / 35
Art. No. 1211-01/1211-02

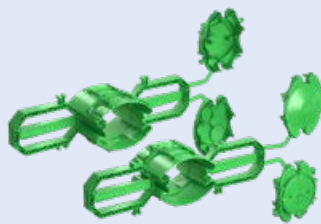

B' 45° domed box
Art. No. 1249-11
Art. No. 1249-12



B' ceiling junction box
Art. No. 1265-11 / 1265-12 / 1260-11

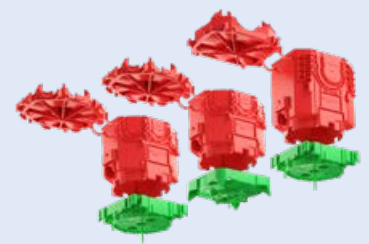

End and transition bush
Art. No. 1204-24/34/29



Wall and ceiling transition 30°
Art. No. 1202-04/34/29



HaloX® 100/180/250 front parts for facing concrete
1281-61...67 / 1282-61...66 / 1283-61...66 / 1281-68/69



HaloX® Styrofoam moulded parts for facing concrete
1292-90

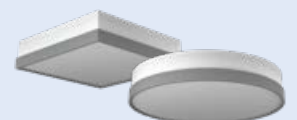

Electrical installation in concrete. At a glance.

The KAISER colour system.

The different colours of the individual components facilitate correct assembly.

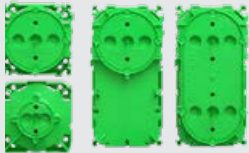

Green
Front parts for fixing to the formwork.

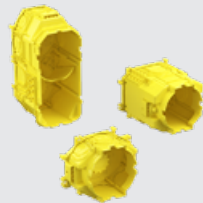

Yellow
Box and casing rear parts for wall installation.



Red
Box rear parts for ceiling installation.

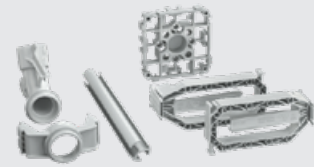

Grey
Intermediate parts and attachment accessories.

Installation in on-site mixed concrete.

www.kaiser-elektro.org/ortbeton



Concrete construction boxes for fixing to the reinforcement



Prefix® 60
1211-01 | P. 6



Prefix® 35
1211-02 | P. 6

Installation in walls



B1 one-gang box
1255-01 | P. 13



B1 one-gang junction box
1265-01 | P. 13

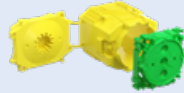

B1 large conduit one-gang junction box
1260-01 | P. 13



B1 wall light connection box
1248-01 | P. 13

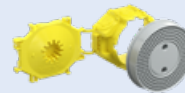

B1 universal wall exit
1248-03 | P. 13



One-gang box
1255-43



Junction box
1276-70



Junction box
1276-71



PERILEX® one-gang box
1276-40



CEE one-gang box
1275-40

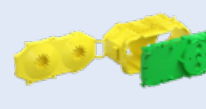

B1 electronics box
1268-01 | P. 13



B1 two-gang junction box
1269-01 | P. 13

Accessories



B1 Prefix® system wing set
1211-00 | P. 13



Abutment for adhesive foil
1205-02



Abutments
1210-02



Support element
Ø 20 mm
1212-...



Adhesive foil
1219-00



Distance piece 91
1259-04 | P. 13

Junction casings



Junction casing
115 x 115 x 76 mm
9909.01



Junction casing
115 x 115 x 101 mm
9908.01



Junction casing
115 x 115 x 150 mm
9908.21



Junction casing
115 x 115 x 105 mm
9907



Junction casing
128 x 128 x 80 mm
1295-02 | P. 15



Junction casing
180 x 180 x 82 mm
1296-02 | P. 15



Junction casing
250 x 220 x 82 mm
1297-02 | P. 15



Equipotential bonding casing
250 x 220 x 82 mm
1297-75



Equipotential bonding casing
128 x 128 x 80 mm
1295-73

Installation in ceilings



B¹ ceiling junction box
1265-11 | P. 17



B¹ ceiling junction box
1265-12 | P. 17



B¹ large conduit ceiling junction box
1260-11 | P. 17



B¹ universal ceiling exit 45°
1249-13 | P. 17



B¹ universal ceiling exit
1265-13 | P. 17



Ceiling exit
9955 | P. 17

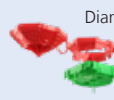

B¹ domed box 45°
1249-11 | P. 17



B¹ domed box 45°
1249-12 | P. 17



Large slab ceiling box 115
1227-50 | P. 17



Slab ceiling box for retrofitting
1247-01 | P. 17



Universal ceiling and wall exit
9959 | P. 17



Ceiling junction box
1245-63



Ceiling junction box
1245-62



Light hook
1225-../1226-... | P. 17



Signal cover
1181-35

Wall to ceiling transitions

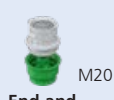

End and transition bush
1204-24 | P. 19

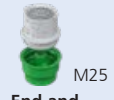

End and transition bush
1204-34 | P. 19

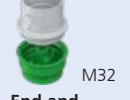

End and transition bush
1204-29 | P. 19



End and transition bush
1203-28 | P. 19

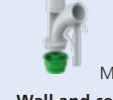

Wall and ceiling transition
1202-04 | P. 19



Wall and ceiling transition
1202-34 | P. 19



Wall and ceiling transition
1202-29 | P. 19

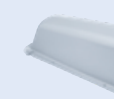

Ceiling strip
4552 | P. 19



Ceiling strip (Ceiling exit)
1283-33 | P. 19



Ceiling strip (Ceiling exit)
1283-34 | P. 19

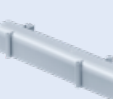

Formwork protection
4558 | P. 19



Speedy formwork protection
4551 | P. 19



B¹ Prefix® wall exit adapter
1211-20 | P. 19



B¹ Prefix® wall exit adapter
1211-25 | P. 19



B¹ Prefix® wall exit adapter
1211-32 | P. 19



B¹ Prefix® system wing set
1211-00 | P. 19



Wire-pull casings.











Wire-pull casings

						
Wire-pull and junction casings 175 x 120 x 64 mm 9912.01	Wire-pull and junction casings 170 x 115 x 95 mm 9911.01	Wire-pull casing⁴ 250 x 180 x 120 mm 9916 P. 21	Wire-pull casing⁴ 250 x 180 x 185 mm 9916.21 P. 21	Wire-pull casing⁴ 400 x 300 x 120 mm 9917 P. 21	Wire-pull casing⁴ 400 x 300 x 220 mm 9917.21 P. 21	
						
Upper frame 9917.68 / 9916.68 P. 21	Plaster cover 9917.06 / 9916.06 P. 21	Screw-on cover 9917.02 / 9916.02 P. 21	Waterproof cover 9917.03 / 9916.03 P. 21	Prefix® wing set 9940.. P. 21	Telescope support 9957	Wire-pull casing 250 x 105 x 94 mm 9914.01



Precast concrete.











Installation in walls

					
One-gang junction boxes with recess (48.5 mm) 1262-06 P. 27	One-gang junction boxes with recess (68.5 mm) 1263-06 P. 27	One-gang junction boxes with recess (83.5 mm) 1264-06 P. 27	One-gang junction box (48.5 mm) 1262-60 P. 27	One-gang junction box (68.5 mm) 1263-60 P. 27	One-gang junction box (83.5 mm) 1264-60 P. 27
					
One-gang junction box (48.5 mm) 1262-61	One-gang junction box (68.5 mm) 1263-61 P. 27	One-gang junction box (83.5 mm) 1264-61 P. 27	Conduit connector 60° 1266-25 P. 27	Conduit connector 1261-20/25/32/40 P. 27	

Accessories

						
Distance piece 142 1261-18	System magnet 1299-69 P. 25	System magnet PLUS 1299-70 P. 25	Plaster compensation ring 1261-60	Extension element 10 to 50 mm 1261-10 P. 27	Abutments 1261-11	Universal Extension element 1261-06/07/08/09

Installation in ceilings

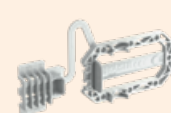
						
Large slab ceiling box 115 1227-16 P. 29	Large slab ceiling box 105 1227-55 P. 29	Large slab ceiling box 105 1227-54 P. 29	Slab ceiling box for retrofitting 1247-01 P. 29			
						
End and transition bush, Ø 20 mm 1261-82 P. 31	End and transition bush, Ø 25 mm 1261-83 P. 31	End and transition bush, Ø 32 mm 1261-84 P. 31	Wall and ceiling transition 30° Ø 20 mm 1261-82 P. 31	Wall and ceiling transition 30° Ø 25 mm 1261-83 P. 31	Wall and ceiling transition 30° Ø 32 mm 1261-84 P. 31	Prefix® universal support 1261-00

Installation in ceilings



Wall to ceiling transition
1261-12 | P. 32



Wall to ceiling transition
1261-73 | P. 32



Wall to ceiling transition
1261-16 | P. 32



Wall to ceiling transition
1261-14 | P. 32



Oval funnel
1261-42 | P. 32



Oval funnel
1261-43 | P. 32

www.kaiser-elektro.org/ortbeton



Installation housing for on-site mixed concrete.

Installation dimension up to Ø 100 mm



HaloX® 100 for on-site mixed concrete
1281-00 | P. 34



HaloX® 100 with tunnel 190 for on-site mixed concrete
1281-30 | P. 34



HaloX® 100 multi-conduit entry
1281-15 | P. 34



HaloX® 100 front parts
1281-01..07 | P. 37



HaloX® 100 front parts for square CE
1281-08/09 | P. 37



HaloX® 100 front parts for facing concrete
1281-61..67 | P. 37



HaloX® 100 front parts for square CE, for facing concrete
1281-68/69 | P. 37



HaloX® 100 universal front part, plastic
1281-10 | P. 37



HaloX® 100 universal front part with mineral fibreboard
1281-11 | P. 37



HaloX® Styrofoam moulded parts
1292-90 | P. 37



HaloX® 100 extension rings
1281-21/25/50 | P. 34



Prefix® installation set
1299-65 | P. 33

Installation dimension up to Ø 180 mm



HaloX® 180 for on-site mixed concrete
1282-00 | P. 41



HaloX® 180 with tunnel 190 for on-site mixed concrete
1282-30 | P. 41



HaloX® 180 with tunnel 325 for on-site mixed concrete
1282-40 | P. 41



HaloX® 180 front parts
1282-01..06 | P. 37



HaloX® 180 front parts for facing concrete
1282-61..66 | P. 37



HaloX® 180 universal front part, plastic
1282-10 | P. 37



HaloX® 180 universal front part with mineral fibreboard
1282-11 | P. 37



HaloX® Styrofoam moulded parts
1292-90 | P. 37



HaloX® 180 extension rings
1282-25/50 | P. 41



Installation set for wall installation
1299-60...64 | P. 41



Prefix® installation set
1299-66 | P. 41



Signal cover Ø 68 mm
1281-31 | P. 43



Signal cover Ø 75 mm
1281-32 | P. 43



Signal cover Ø 80 mm
1281-33 | P. 43

Installation dimension up to Ø 250 mm



HaloX® 250 for on-site mixed concrete
1283-00 | P. 41



HaloX® 250 with tunnel 325 for on-site mixed concrete
1283-40 | P. 41



HaloX® 250 front parts
1283-01..06 | P. 37



HaloX® 250 front parts for facing concrete
1283-61..66 | P. 37



HaloX® 250 universal front part, plastic
1283-10 | P. 37



HaloX® 250 universal front part with mineral fibreboard
1283-11 | P. 37



HaloX® Styrofoam moulded parts
1292-90 | P. 37



HaloX® 250 extension rings
1283-25/50 | P. 41



Installation set for wall installation
1299-60...64 | P. 41



Prefix® installation set
1299-66 | P. 41



Installation housing for precast concrete.

Installation size up to Ø 180 mm | adhesive attachment



HaloX® 180
1282-71 | P. 45



HaloX® 180 with tunnel 190
1282-72 | P. 45



HaloX® 180 with tunnel 325
1282-73 | P. 45



HaloX® 180 extension rings
1282-25/50 | P. 45



HaloX® 180 replacement mineral fibreboard
1282-27 | P. 45

Installation size up to Ø 180 mm | magnet attachment



HaloX® 180
1282-74 | P. 45



HaloX® 180 with tunnel 190
1282-75 | P. 45

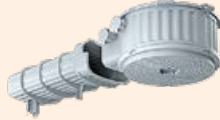

HaloX® 180 with tunnel 325
1282-76 | P. 45



HaloX® 180 extension rings
1282-25/50 | P. 45



System magnet
1299-69 | P. 25



System magnet PLUS
1299-70 | P. 25

Installation size up to Ø 250 mm | adhesive attachment



HaloX® 250
1283-71 | P. 45



HaloX® 250 with tunnel 325
1283-73 | P. 45



HaloX® 250 extension rings
1283-25/50 | P. 45



HaloX® 250 replacement mineral fibreboard
1283-27 | P. 45

Installation size up to Ø 250 mm | magnet attachment



HaloX® 250
1283-74 | P. 45



HaloX® 250 with tunnel 325
1283-76 | P. 45



HaloX® 250 extension rings
1283-25/50 | P. 45



System magnet
1299-69 | P. 25



System magnet PLUS
1299-70 | P. 25



Signal cover Ø 68 mm
1281-31 | P. 43



Signal cover Ø 75 mm
1281-32 | P. 43



Signal cover Ø 80 mm
1281-33 | P. 43



Universal installation housing.



Universal installation housing 90 x 90 x 70 mm
1223-22 | P. 49



Universal installation housing 150 x 90 x 70 mm
1224-22 | P. 49



Universal installation housing 128 x 128 x 86 mm
1295-22 | P. 49



Universal installation housing 180 x 180 x 90 mm
1296-22 | P. 49



Universal installation housing 250 x 220 x 90 mm
1297-22 | P. 49



Universal installation housing 258 x 188 x 135 mm
1298-37 | P. 49



Universal installation housing 258 x 188 x 200 mm
1298-38 | P. 49



Universal installation housing 408 x 308 x 135 mm
1297-34 | P. 49



Universal installation housing 408 x 308 x 235 mm
1297-35 | P. 49

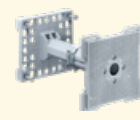

Telescope support
9957

Installation housings for retrofitting.

Installation dimension up to Ø 100 mm



HaloX® 100 installation kit
1281-20 | P. 50



HaloX® housing for drilling holes in solid ceilings
1290-30 | P. 51

Facing concrete.



B¹ one-gang box
1255-01 | P. 53

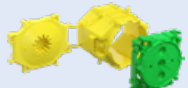

B¹ one-gang junction box
1265-01 | P. 53

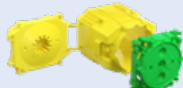

B¹ large conduit one-gang junction box
1260-01 | P. 53



Prefix® 60
1211-01 | P. 53



Prefix® 35
1211-02 | P. 53



B¹ domed box 45°
1249-11 | P. 53



B¹ domed box 45°
1249-12 | P. 53



B¹ ceiling junction box
1265-11 | P. 53



B¹ ceiling junction box
1265-12 | P. 53



B¹ large conduit ceiling junction box
1260-11 | P. 53



End and transition bush
1204-24 | P. 53

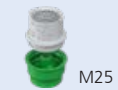

End and transition bush
1204-34 | P. 53



End and transition bush
1204-29 | P. 53



Wall and ceiling transition
1202-04 | P. 53



Wall and ceiling transition
1202-34 | P. 53



Wall and ceiling transition
1202-29 | P. 53



HaloX® 100/180/250 front parts for facing concrete
1281-61..67 / 1282-61..66 / 1283-61..66 | P. 53



HaloX® 100 front parts, square for facing concrete
1281-68/69 | P. 53



HaloX® Styrofoam moulded parts for facing concrete
1292-90 | P. 53

www.kaiser-elektro.org/werkzeuge



Installation in concrete.

Tools



Universal Opening cutter
Art. No 1085-80

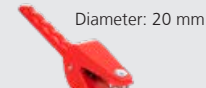

Punch pliers
Art. No. 1286-33

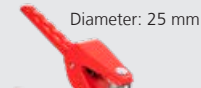

Punch pliers
Art. No. 1286-34



AMZ 2 stripping pliers
Art. No. 1190-02



Reamer
Art. No. 1284-34/35/36



Step drill
Art. No. 1284-32



Hole punch and expanding dowel fitting tool
Art. No. 1284-62/63



Nail inserter
Art. No. 1284-69/68

Systems and solutions for professional electrical installation work.

KAISER has been developing and producing systems and products as the basis for professional installation work since 1904. Planners and fitters all over the world use our practice-oriented solutions for their daily work in all installation areas.



Energy efficiency.

Innovative KAISER products help you to ensure compliance with the requirements of EU Directives and national regulations such as the Energy Savings Regulations (EnEV).



Radiation protection.

The use of the new radiation protection boxes allows the radiation protection of the wall to be maintained without additional shielding measures.



Fire protection.

KAISER fire-protection systems provide reliable solutions for electrical installations in fire-protection walls and ceilings.



Construction.

KAISER has matching product system solutions for safe, durable and practical use in redevelopment, renovation and modernisation projects.



Sound insulation.

KAISER's innovative sound insulation boxes ensure compliance with the construction requirements for sound insulation walls, as well as for built-in installations.



Concrete construction.

Complete systems for on-site mixed concrete and pre-cast concrete. Fully optimised to professional electrical installation work.

Technical information and advice

All further information on products, system solutions and communication media can be found on our website at www.kaiser-elektro.de

For any additional questions or information, please do not hesitate to contact our technical support team who will be happy to assist you: **+49 (0) 23 55 / 809-61** · technik@kaiser-elektro.de

KAISER GmbH & Co. KG

Ramsloh 4 · 58579 Schalksmuehle
GERMANY

Phone: +49 (0) 23 55 8090 · Fax: +49 (0) 23 55 80921
www.kaiser-elektro.de · info@kaiser-elektro.de

