



Application description

KNX thermostat
KNX room controller









- ▲  Manufacturer
- ▲  Berker
- ▲  KNX thermostat
 -  KNX thermostat with display and integrated bus application unit
 -  KNX room controller with display and integrated bus application unit

Application description

KNX thermostat with display and integrated bus application unit
KNX room controller with display and integrated bus application unit



	Order number	Product designation	Application programme	TP product 
	8044 01 00	KNX thermostat with display and integrated bus application unit	S80440100 / 80660100 	
	8066 01 00	KNX room controller with display and integrated bus application unit	S80440100 / 80660100 	

Application description

KNX thermostat
KNX room controller



Table of contents

1. General	5
1.1 General information about this application description	5
1.2 General information about the programming software	5
1.2.1 ETS Programming software	5
1.2.2 ETS Application designation 	5
2. Functional and device description	6
2.1 Device overview	6
2.2 Functional description	7
2.3 Display elements and operating concept	7
2.4 Operating a function	9
2.5 Functional overview thermostat/room controller	9
2.5.1 Settings in the ETS	9
2.5.2 Settings on the display	11
2.6 Display data in normal operation	12
2.6.1 Display of temperatures	12
2.6.2 Display of date and time	12
2.7 Display of user messages and status message	12
3. Selection Room Thermostat Type	12
4. Display	14
4.1 General display settings in the ETS	15
4.1.1 Screen brightness	16
4.1.2 Screensaver	17
4.1.3 Display language	18
4.2 User messages	19
4.3 Time	20
4.3.1 Display setting date/time	21
4.3.2 24 ^h /12 ^h Time format	21
4.4 Setting the page "Basic display"	22
4.5 State of the house	24
4.5.1 Page Status - messages	26
4.6 Blocking function	28
4.7 Push-push-button	29
5. Room thermostats	30
5.1 General	30
5.2 Mode selection	34
5.3 Mode selection changeover	35
5.3.1 Notes on mode selections	39

Application description

KNX thermostat
KNX room controller



5.3.2	Holiday mode	42
5.3.3	Transmission of set temperature	43
5.4	Mode selections and mode selections changeover	43
5.5	Basic heating	45
5.6	Additional heating	47
5.7	Setpoint heating on display	48
5.8	Basic cooling	49
5.9	Additional cooling	51
5.10	Setpoint cooling on display	52
5.11	Heating or cooling mode	53
5.12	Temperature measurement	54
5.13	Ventilation	58
5.14	Transmission settings	62
5.15	Setpoints	63
5.16	Basic display	65
5.17	Scene settings	66
6.	Temperature sensor settings	67
6.1	Internal temperature sensor	67
6.2	External temperature sensor	69
7.	Push-push-button functions	71
7.1	Display mode "Multiple functions" / "Rocker function"	71
7.1.1	Rocker function push-button	72
7.1.2	Multiple function push-button	72
7.2	Toggle switch function	73
7.3	Function switching	74
7.4	Function dimming	76
7.5	Shutter/blind function	78
7.5.1	Shutter function	78
7.5.2	Function blind	79

Application description

KNX thermostat
KNX room controller



7.6	“Timer” function	81
7.7	“Value 1 byte” function	82
7.8	Value 2 bytes function	83
7.9	Priority function	84
7.10	Scene function	86
7.11	Deactivate automatic function	88
7.12	Blocking function	91
8.	Further display settings	92
8.1	Config mode	92
8.2	Reset	92
8.3	Info	93
9.	Page Timer	94
10.	Page No problem	95
11.	ETS software characteristics	96
12.	Technical data	96
13.	Accessories	96
14.	Warranty	97

Application description

KNX thermostat
KNX room controller



1. General

1.1 General information about this application description

This document describes the operation and parameterisation of KNX devices with the aid of the Engineering Tool Software ETS.

The devices thermostat and room controller are parameterised by the ETS during initial installation and the required settings are made. Furthermore, the devices offer the possibility to change settings on display.

Symbol description:

Descriptions which list the display sign , are device settings that can be made via the display.

Descriptions which list the ETS sign , are device settings that can be made in the ETS software only.

1.2 General information about the programming software

1.2.1 ETS Programming software

The application programmes are compatible with ETS5 or ETS4 and are always available in their latest version on our Internet website.

ETS version	File extension of compatible products	File extension of compatible projects
ETS 4 (v 4.18 and higher)	*.knxprod or *.vd5	*.knxproj
ETS 5 (v 5.04 and higher)	*.knxprod	*.knxproj

Table 1: ETS Software version

1.2.2 ETS Application designation

Application	Article order number
S80440100 / 80660100	KNX thermostat with display and integrated bus application unit
S80440100 / 80660100	KNX room controller with display and integrated bus application unit

Table 2: ETS Application designations

Application description

KNX thermostat
KNX room controller

2. Functional and device description

2.1 Device overview

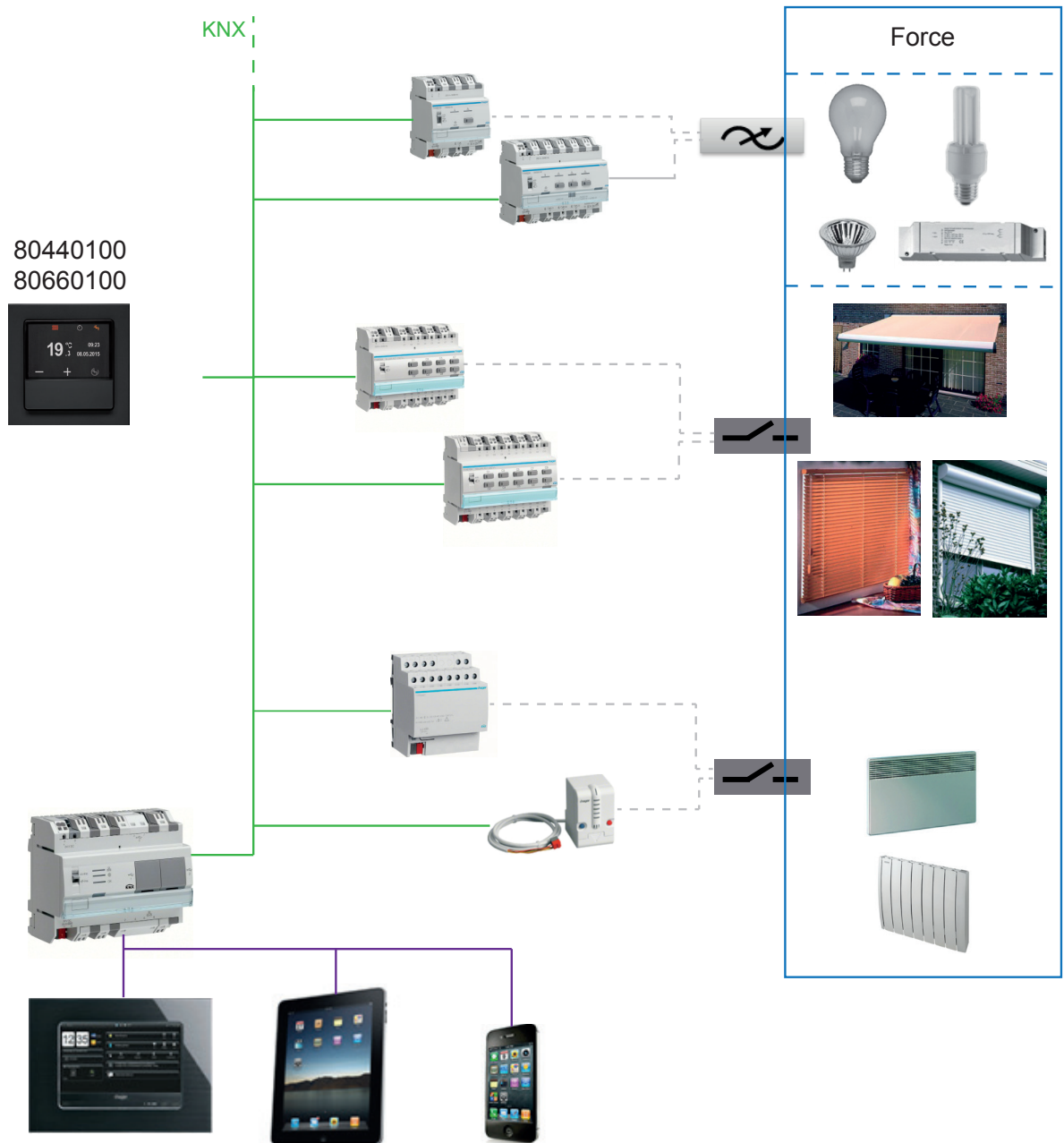

Application description

KNX thermostat
KNX room controller

2.2 Functional description

The KNX thermostat can be used to control the temperature of individual rooms. In the course of this, the command value for the heating or cooling control is sent to the KNX bus depending on the mode selection and room temperature.

Additional functions of the device are e.g. fan coil control, holiday mode, status display , etc..

The device „**KNX thermostat**“ compares the current room temperature with the set temperature and controls heating and cooling devices according to the current requirements.

The device „**KNX room controller**“ also has push-push-button functions. Here, the following functions can be retrieved: ON/OFF, dimming, shutter/blind, light scene activation, priority. The assignment of the various functions is freely selectable and is defined by parameterisation in the ETS. Depending on the parameterised functions, telegrams that trigger ON/OFF, dimming, blind/shutter functions, call up or save light scenes and set dimming, brightness or temperature values in the corresponding actuators are transmitted to the KNX system bus when touch control surface is pressed.

2.3 Display elements and operating concept

The device is subdivided into a display area (1) and a control surface area (2). On the page “Basic display” symbols indicate the set/active parameters in the upper row of the display. The lower row of the display area changes its display depending on the page. Symbols indicate the functions that can be triggered using the touch control surface (2) below. Greyed out symbols indicate a deactivated function.

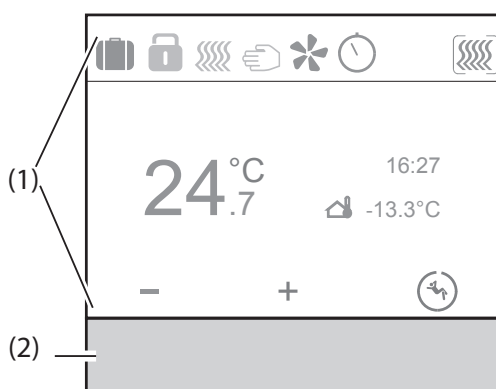

Figure 2: Display elements

- (1) Display area
- (2) Operating area

Application description

KNX thermostat
KNX room controller

– Push-push-button operation:

The stored function is executed by pressing the touch control surface below the displayed symbol (3).

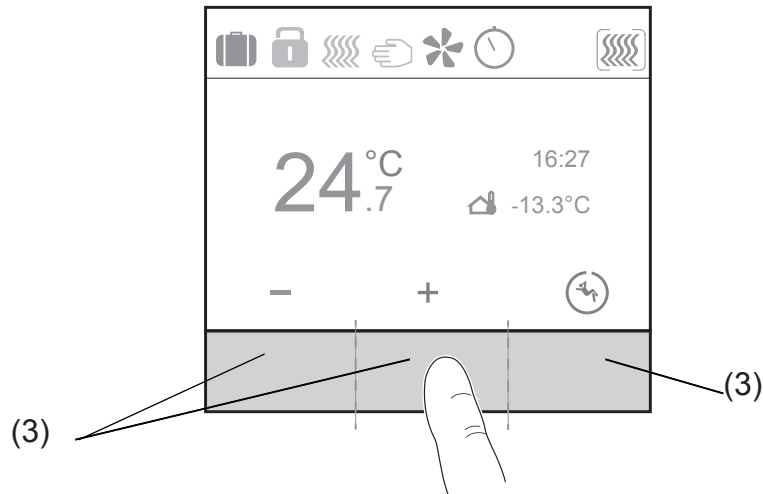

Figure 3: Operating concept "Push-push-button operation"

(3) Push-push-button zones

– Slider operation:

The respective pages are navigated to by "swiping" over the capacitive touch control surface (4). Here, the movement can take place from left to right or reverse direction. The swiping action on a submenu page brings you back to the main page.

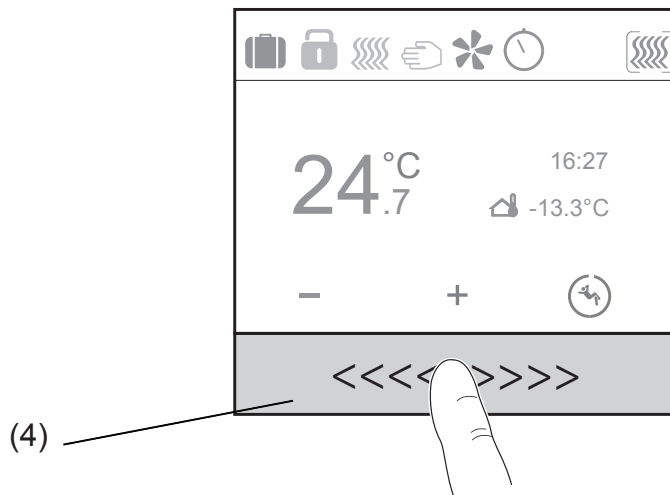

Figure 4: Operating concept "Slider operation"

(4) Slider control surface

Application description

KNX thermostat
KNX room controller

2.4 Operating a function

Loads, such as lighting or blinds, are operated using the touch-sensitive control surface and is dependent on the device configuration.

- Press a touch control surface below the symbols.
The stored function is executed.



The pulse lasts for the duration of the actuation. Depending on the function, short and long touches can trigger different actions, e.g. switching/dimming.

2.5 Functional overview thermostat/room controller

The functions described in the following sections enable the individual operation of the devices. The devices have to be configured in the ETS  for commissioning. Afterwards, defined settings and parameters can also be changed via the display. Settings via the display, such as change display language, or set timer, can already be made before start-up.

-  The settings made on the display prior to programming by the ETS will be overwritten by an ETS download.

2.5.1 Settings in the ETS

-  The application software imported to the ETS is identical for the devices "Thermostat with display and integrated bus coupling unit" and "Room controller with display and integrated bus coupling unit".
-  In the first step, the device variants used must be selected.

Menu Room Thermostat Type

In the menu Room Thermostat Type you have to choose between the thermostat variants or room thermostats.

Menu Display

In the Display menu, the basic parameters for operation of the device must be set, such as language, time, time format, display brightness, screensaver, basic display etc.

Menu Thermostat

In the Thermostat menu, the parameters for heating, cooling operation, fan, temperature setpoints (comfort, standby, night operation, frost/heat protection) and the scene settings must be parameterised.

Menu Internal temperature sensor

The settings for the internal temperature sensor must be performed in the Internal temperature sensor menu.

Menu External temperature sensor

The settings for the external temperature sensor must be performed in the External temperature sensor menu.

Application description

KNX thermostat
KNX room controller

Push-button 1 ... Push-button 9

- i** In addition to the functions of the thermostat, the room controller has the option to create your own display pages. On these pages, it is possible to create switching, dimming and roller shutter/blind functions among other things.

Not active

The "Not active" function means that no function is assigned to the push-button; the push-button is disabled. No further page is generated in the display.

Toggle switch

The "Toggle switch" function switches on the load upon the first key-press and switches it off again upon the second. "Page Push-button function"

Switching

The "ON/OFF" function enables the push-push-button (lighting circuits, for example) to be switched on or off (ON, OFF, ON/OFF, for example).

Dimming

The "Dimming" function enables the push-push-button to increase and decrease the dimming in lighting circuits. This function can either be used as a rocker (for example, left side of the rocker dims up, right side dims down) or as a push-button (first key-press dims up, second dims down (during toggle mode)).

Shutter/blind

The "Shutter/blind" function allows blinds, shutters, awnings or similar hangings to be opened and closed.

This function can either be used as a rocker (for example, left side of the rocker OPENS shutter, left side CLOSES shutter) or as a push-button (first key-press OPENS shutter, second CLOSES shutter (during toggle mode)).

Timer

The "Timer" function enables the actuator output to be switched on or off for an adjustable duration. The switching time can be interrupted before the delay time elapses. An adjustable switch-off warning signals the end of the delay time by inverting the output state for 1 s.

Value 1 byte/2 bytes

The value transmitter (1 byte) function allows values from 0 to 255 or 0 to 100 % to be transmitted to a dim actuator, for example.

The value transmitter (2 bytes) function allows values from 0 to 65535, brightness values from 0 to 1000 lx or temperature values from 0 to 40°C to be configured.

Mandatory control

The Priority function makes it possible to specify a defined state or to force a defined state of the function.

Scene

With this function, a light scene can be called up in a KNX device (scene extension). A scene can have various functions e.g. light circuit 1 ? dimming, lower shutter 1 ?, TV lighting ? ON, merge into a group. A maximum of 64 scenes are available.

Deactivate automatic

This function can be used to interrupt and deactivate ongoing operations (time-controlled lighting).

Application description

KNX thermostat
KNX room controller

2.5.2 Settings on the display

Once the devices have been parameterised via the ETS and put into operation, settings can also be changed on the display. For example, the setpoint temperature for heating/cooling can be changed or a new screensaver can be selected.

Page Settings

On the “Settings” page, the basic functions and parameters of the device are to be set/changed manually. The following parameters are to be configured under Settings:

- Setpoint heating
- Setpoint cooling
- Internal sensor
- External sensor
- Heating or cooling mode
- Date/time
- 24^h/12^h Time format
- Screen brightness
- Screensaver
- Language
- Config mode
- Reset
- Info

Page Timer

On the “Timer” page you have to set on which weekdays or sections of the week and at what times the mode selections Comfort, Standby or Night mode (Night Reduction) should be switched on and off.

Application description

KNX thermostat
KNX room controller

2.6 Display data in normal operation

The following information is displayed in idle mode:

- the current room temperature,
- the current outside temperature,
- date or time,
- screensaver (analogue/digital clock, company logo, etc.)

The following information is displayed on the page "Basic display" of the device:

- Date
- Time
- Outdoor Temperature
- Room temperature
- Temperature setpoint

In the "Display - General" parameter branch the settings must be set for the "basic display" page and standby operation.

The possible display information is described in more detail in the following sections.

2.6.1 Display of temperatures

The following temperatures can be displayed:

- current room temperature (determined via internal temperature sensor, or alternatively, via the connected, external temperature sensor in the case of larger rooms)
- current outside temperature (determined via external temperature sensor)

The temperature display has a resolution of 0.5 °C and covers a range from - 30 °C to + 80 °C.

2.6.2 Display of date and time

The product has an internal timer. Time and date have to be set once in the settings during the initial setup. The time and data can also be set via the bus (timer) for synchronisation with other bus devices if requested. If the time is controlled via the internal clock, the parameter must still be set for changing to daylight saving time. Furthermore, the time format, 24h or 12 AM/PM, can be freely selected in both cases.

The external time signal should be transmitted hourly in order to keep the rate deviation of the clock as small as possible. As long as no time signal or date signal has been received via the objects, "--:--" appears in the display.

2.7 Display of user messages and status message

User or status messages are displayed on the "Status" page. It is possible to display three predefined user messages with a maximum length of 20 characters on the display of the device. General information on the property management or text messages from alarm central units are possible, for example.

To activate when the text display should appear on the display, "Polarity (0/1)" must be set in the parameter branch "Display - user message".

Furthermore, status messages can be depicted in text format. To do this, in the parameter branch "Display - State of the house - Status message" select the object type "1 bit, 1, 2, 4 byte". Depending on the selected object type, status texts with a max. length of 20 characters incl. details of the measuring unit are to be set.

3. Selection Room Thermostat Type

In the first step, the KNX thermostat or KNX room controller device variants used must be selected in the application software. If the KNX room controller is selected, the parameters of push-buttons 1 ... 9 are visible.



Room thermostat type

Application description

KNX thermostat
KNX room controller

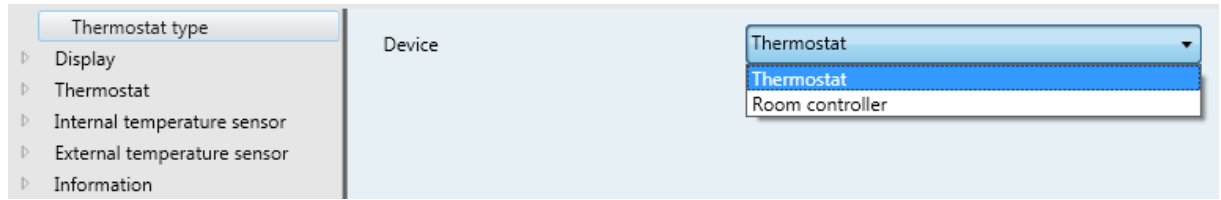

Figure 5: Selection device variant

Parameters	Description	Value
Product	With this parameter, the device type used must be selected at the beginning of the parameterisation	KNX thermostat KNX room controller

Table 3: Selection device variant

Application description

KNX thermostat
KNX room controller

4. Display

In this section, the view and function of the "basic display" page are illustrated and described for both device variants. The device is subdivided into two areas:

- **Display area "A"**
- **Control surface "B"**

i The "basic display" page in the figure below is only shown as an example and may display other parameters depending on the setting.

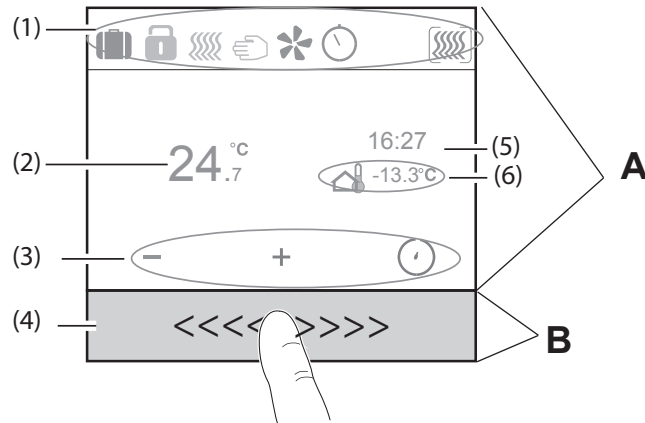

Figure 6: Basic display

- (1) 1 Status line with symbols
- (2) Display of current room temperature
- (3) Function symbols for the touch control surface
- (4) 4 Touch-sensitive control surface (Slider)
- (5) Display of the time
- (6) Temperature display of the external temperature sensor

In the status line (1) the current device settings are represented as a symbol. The function symbols (3) change depending on the page. The displaying of time (5) and temperature value of the external temperature sensor (6) can be set and selected individually.

Application description

KNX thermostat
KNX room controller



4.1 General display settings in the ETS

In the general display settings, you have to set the parameters brightness during daytime or night operation, action if device not operated, authorisation for local operation and choice of device language.

The screen brightness can be adjusted for daytime and nighttime operation.

In the parameter "Action if product not operated after set time", the behaviour is defined that should be displayed or should occur after a selectable time has elapsed.

The settings to "NO ACCESS" in the "access level" parameter must be made in public areas in order to prevent adjustments of the default setting.

i If installed in public areas, such as schools, office buildings, administrative buildings, particular attention should be paid to this parameter in order to avoid unintended use.

i In private areas, this function can be regarded as a child protection lock.

Furthermore, the language must be chosen for the display texts.

Display → General

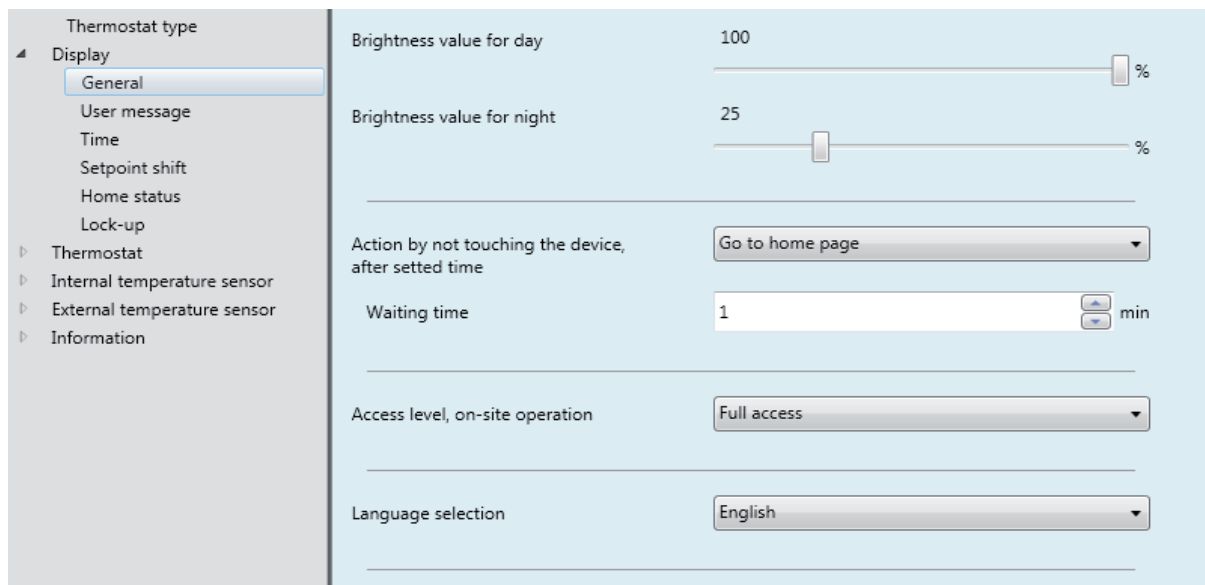

Figure 7: General settings

Parameters	Description	Value
Brightness value daytime operation	The display brightness for daytime operation is set with this parameter.	Day 0 ... 100 % *
Brightness value nighttime operation	The display brightness for nighttime operation is set with this parameter.	Night 0 ... 25% * ... 100 %
Action after set waiting time if product is not operated	With this parameter you can set which information the device should display or which action should be performed once the waiting time has elapsed.	No change Go to start page * Go to start page + switch the display off Go to start page + set screen brightness to night mode Go to start page + screensaver
Waiting time	The parameter defines after which time period the device should change to the above mode.	1 min * ... 255 min

Application description

KNX thermostat
KNX room controller



Screensaver ¹	Here the screensaver type can be set.	Analogue clock * Digital clock Logo Outside temperature + time Room temperature + time Operation help
Access level, local operation	Here, you can set the access authorisation for the device. This parameter is useful in public areas, in which certain device settings are disabled.	Full access * Limited access No access
Choice of language	This parameter presets the device language.	English, French, German, Italian, Portuguese, Spanish, Dutch, Swedish, Danish, Finnish, Norwegian, Turkish, Polish

Table 4: General Settings

¹ This parameter is only visible when selecting "Go to start page + screensaver".

4.1.1 Screen brightness

The display brightness can also be adjusted on the product itself.

On the "Settings" page the brightness value can be readjusted via the "Brightness value" entry.

i The readjusted value is linked to the operation currently active (day / or night operation).

Settings page → Screen brightness

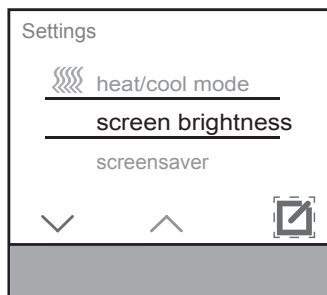

- In the Settings menu, select "Screen brightness" parameter using the arrow buttons \wedge / \vee and confirm with \boxtimes .

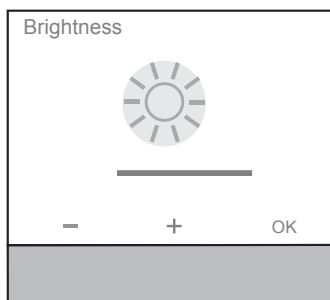

- Use + / - buttons to set the brightness value.
- Press **OK** or swipe your finger over the control surface to confirm.

Figure 8: Screen brightness

* Default value

Application description

KNX thermostat
KNX room controller

4.1.2 Screensaver

In the Screensaver menu you can switch the function on/off and configure the display.

Settings menu → Screensaver

The screensaver display can be selected from six different display types.

- Analogue clock
- Digital clock
- Manufacturer logo
- Outdoor Temperature/time
- Room temperature/time
- Operation help
- Deactivated

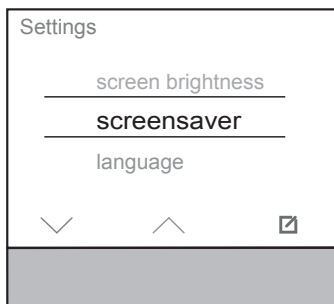

- On the Settings page, select the "Screensaver" parameter using the arrow buttons \wedge / \vee and confirm with .

The "Screensaver" menu opens.

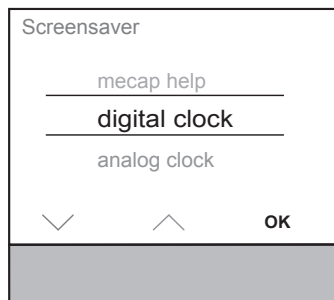

- In the "Screensaver" menu, select the "screensaver type" using the arrow buttons \wedge / \vee .
- Confirm with **OK**.

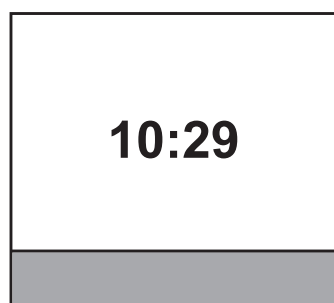

Example:

Screensaver has been selected as digital clock

The current time is displayed.

Figure 9: Screensaver

Application description

KNX thermostat
KNX room controller

4.1.3 Display language

The language is selected under this setting.

Settings menu → Language

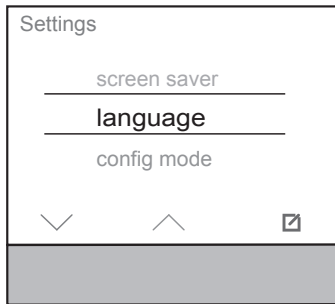

- On the Settings page, select the "Language" parameter using the arrow buttons \wedge / \vee and confirm with . Menu switches.



- In the Language menu, select the desired system language using the arrow buttons \wedge / \vee and confirm with **OK**. The selected system language is set.

Figure 10: Choice of language

Application description

KNX thermostat
KNX room controller



4.2 User messages

Display → User messages

The screenshot shows the configuration interface for user messages. On the left is a navigation tree with 'User message' selected under 'Display'. The main area contains three message configuration blocks. Each block has a text input field for the message (labeled 'Message 1', 'Message 2', and 'Message 3') and a dropdown menu for 'Polarity' (all set to 'ON = 1'). At the bottom, there is a separate dropdown for 'Polarity of reset the alarm message' also set to 'ON = 1'.

Figure 11: User messages

Parameters	Description	Value
Predefined text message x ¹ (max. 20 characters)	This parameter allows you to create a predefined text message with a max. of 20 characters.	Free text x *
Polarity	This setting defines at which value 0/1 the predefined text message is displayed on the corresponding object.	ON = 1* ON = 0
Polarity Reset alarm message	This parameter defines at which value the alarm message is reset on the object.	ON = 1* ON = 0

Table 5: User messages

Communication objects "User messages"

No.	Name	Object function	Length	Data type
3	Display	Reset predefined text message 1	1 bit	1.001 DPT_ON/OFF
4	Display	Reset predefined text message 2	1 bit	1.001 DPT_ON/OFF
5	Display	Reset predefined text message 3	1 bit	1.001 DPT_ON/OFF
6	Display	Alarm message	14 byte	16.000 DPT_Character(ASCII)
7	Display	Reset alarm message	1 bit	1.015 DPT_Reset

¹ A maximum of three messages can be displayed (x = 1;2;3).

The predefined text messages appear on the "Status" page.

* Default value

Application description

KNX thermostat
KNX room controller

4.3 Time

The settings for the time signal (internal or external), change to daylight serving time and time format can be set in this section. The time signal can either be set manually in the display or received via an external source.

 Display → Time

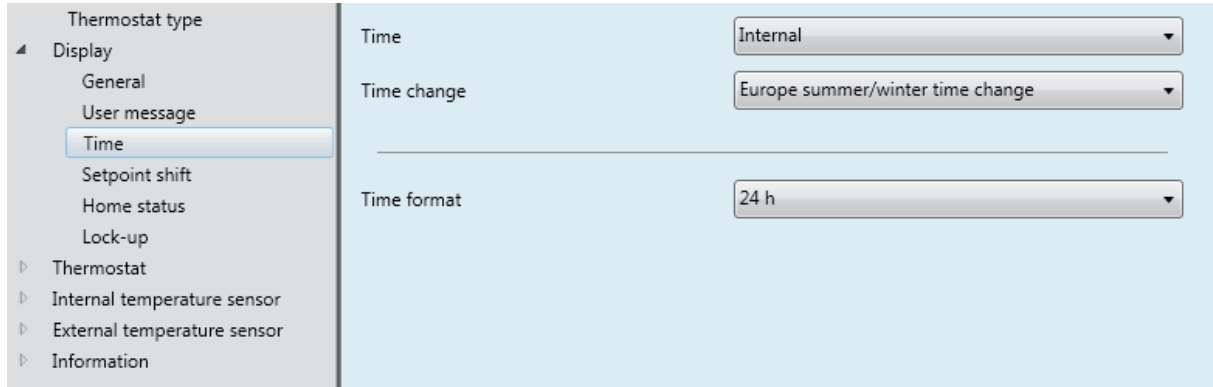

Figure 12: Time

Parameters	Description	Value
Time	With this parameter you choose whether the time is set and started on the display or whether the time signal should be received from an external source (e.g. weather station). ¹	Internal * External
Change to daylight serving time ²	This parameter defines the setting for the summer/wintertime changeover for the respective operating location.	Manual operation Europe summer/wintertime changeover * USA summer/wintertime changeover Australian summer/wintertime changeover
Time format	This parameter sets the time display in the time format appropriate for the operating location.	12h (AM/PM) 24 h *

Table 6: Time

The devices receive the time signal e.g. from a weather station or timer. Two separate communication objects are available for this purpose.

No.	Name	Object function	Length	Data type
91	Date and time	Date	3 byte	11.001 DPT_Date
92	Date and time	Time	3 byte	10.001 DPT_Daytime
93	Date and time	Date and time	8 byte	19.001 DPT_Date/Time
94	Date and time	Date and time	1 bit	1.017 DPT_Trigger

¹ The time signal is generated in the device by a built-in clock. The clock has a power reserve of approx. 4 hours.

² The change to daylight serving time can only be set if the "Internal (Default value)" value is selected. If the "External" value is set, the summer/winter time is changed automatically by the received time signal.

 The communication objects, 91 to 94, are only visible if the time is set to "External" in the parameter branch "Display - time".

* Default value

Application description

KNX thermostat
KNX room controller

4.3.1 Display setting date/time

In the Date/Time menu, the current date and time can be set manually. If the time is to be controlled internally, the time and date are set on the product. To do this, change to the "Settings" page by swiping your finger over the user interface and select the "Date / Time" menu item

 The current date and time are not set in the default state.

Page Settings → Date/time

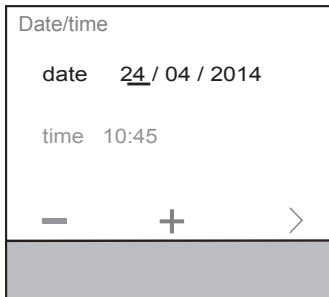

■ In the Date/time menu, first increase/decrease the respective underlined numerical value using + / - buttons in the "Date" parameter.

■ Change to the next adjustable value with >.

 To cancel the operation, simply swipe your finger over the user interface.

 At the last value to be set, the display changes from > to **OK**.

Confirm inputs with **OK**.

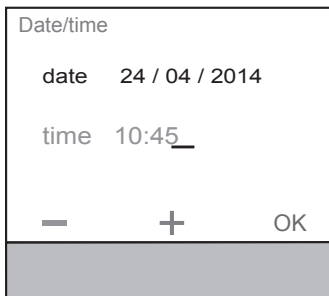
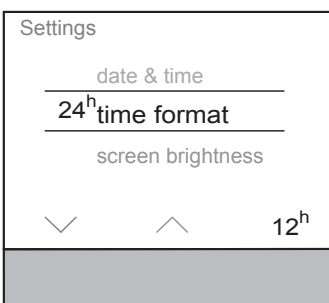

Figure 13: Date/time

4.3.2 24^h/12^h Time format

In the 24^h/12^h menu under Settings, the time can be displayed in 24^h time format or 12^h (AM/PM) time format.

Settings menu → Time format



■ On the Settings page, select the "Time format" parameter using the arrow buttons ^ / v

 The time is set in 24h time format in the default state.

■ Press touch control surface below the display of 12^h.

The time format changes from the 24h to 12h display.

In the function line 24^h appears

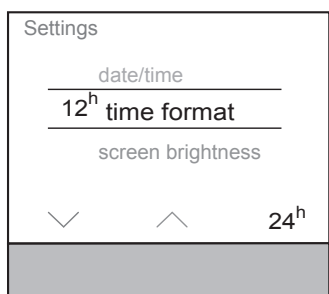

Figure 14: 24^h/12^h Time format

Application description

KNX thermostat
KNX room controller

4.4 Setting the page “Basic display”

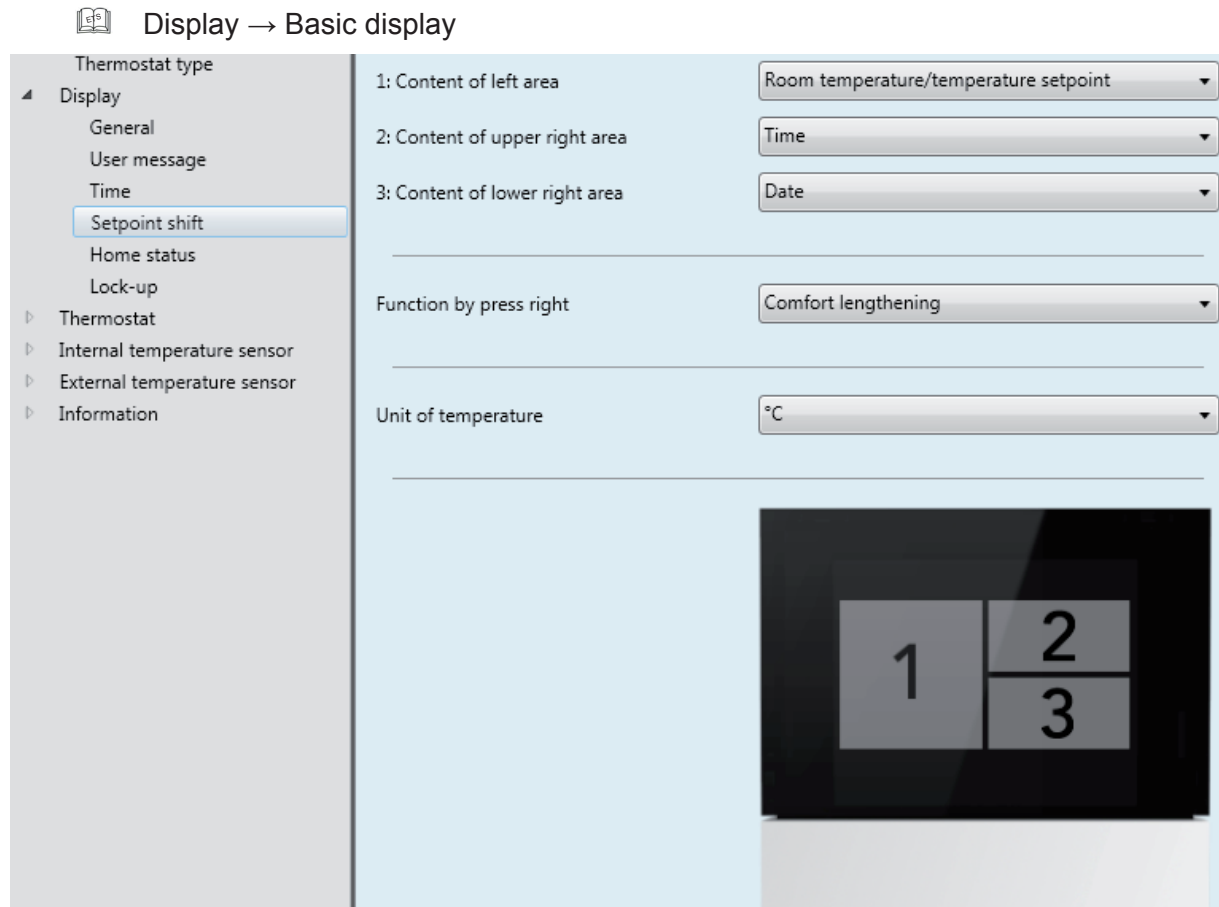

Figure 15: Basic display

Parameters	Description	Value
1: Content of the left surface (also see Figure 16,2)	This parameter sets which value is to be shown on the left display area	Room temperature/Set temperature * Set temperature
2: Content, top right (also see Figure 16, 5)	This parameter sets which value is to be shown on the page “Basic display” on top right	Nothing Date * Time Outside temperature Set temperature
3: Content, bottom right (also see Figure 16, 6)	This parameter sets which value is to be shown on the page “Basic display” on bottom right	Nothing Date * Time Outside temperature Set temperature
Page basic display: Function on right push-button (also see Figure 16, 3)	This parameter sets which functions should be toggled between when pressing the right push-button.	Comfort extension Change-over Comfort/Night-time Temperature Reduction *
Temperature unit	The temperature unit is set with this parameter.	°C * °F  A conversion aid can be found in the ETS under "room temperature → setpoints"

Table 7: Page “Basic display”

* Default value

Application description

KNX thermostat
KNX room controller

Page "Basic display"

In the basic display, the values for inside/outside temperature, time, date and/or set temperature can be displayed depending on the parameterisation.

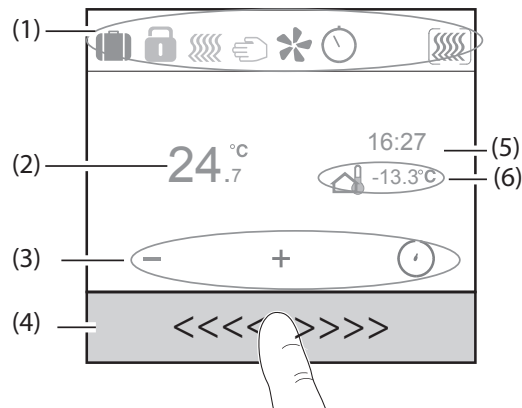

Figure 16: Basic display

- (1) 1 Status line with symbols
- (2) Current room temperature,
- (3) Function symbols for the touch control surface
- (4) 4 Touch-sensitive control surface (Slider)
- (5) Time
- (6) Temperature display external temperature sensor

i The parameters illustrated in Figure 16 are only an example. There are several ways to set the "Basic display" page.

In the status line (1), the current status is represented by symbols. The function symbols (3) change depending on the menu page or function type. The displaying of time (5) current room temperature (2) and temperature value of the external temperature sensor (6) can be set and selected individually.

i A list and description of all symbols can be found in the appendix.

Application description

KNX thermostat
KNX room controller



4.5 State of the house

In the "State of the house" function, depending on the equipment of the entire KNX system, the energy consumption of the heating system can be displayed, for example. Furthermore, it is possible to display the status of the window contacts (window open/closed) and the dew point alarm (controller is switched off). These settings are linked to the "Status" display page.

 Display → State of the house

Figure 17: State of the house

Parameters	Description	Value
Status message	This setting defines which data type, value should be displayed as a status message.	Inactive Value 1 bit * Value 1 bytes Value 2 bytes Value 4 bytes
■ Status value 1 bit switching		
Message if 0	In this parameter, a free text (a maximum of 20 characters) can be entered, which is displayed if a "0" is received.	Free text (a maximum of 20 characters)
Message if 1	In this parameter, a free text (a maximum of 20 characters) can be entered, which is displayed if a "1" is received.	Free text (a maximum of 20 characters)

Application description

KNX thermostat
KNX room controller



■ Status value 1 byte		
Description	In this parameter, a free text (a maximum of 11 characters) can be entered	Free text (a maximum of 11 characters)
1 Byte value, integer	The data type format of the value to be displayed is defined with this parameter.	Value 0 ... 255 * Value 0 ... 100 % Value 0 ... 360 ° Value -127 ... +128
Measuring unit ¹	In this parameter, a text not exceeding 3 characters in length can be entered as a measuring unit.	e.g. ms, kWh, ppm, lux, °, % (a max. of 3 characters)
■ Status value 2-byte		
Description	In this parameter, a free text (a maximum of 11 characters) can be entered	Free text (a maximum of 11 characters)
Number format	The format of the numerical values to be displayed is defined with this parameter.	Integer Floating-point number
2-Byte value, integer	The data type format of the value to be displayed is defined with this parameter.	0 ... 65535 * -32768 ... 32767
Decimal place	If the value "floating-point number" is selected, the number of decimal places must be set in this parameter.	0 *... 2
Measuring unit ¹	In this parameter, a text not exceeding 3 characters in length can be entered as a measuring unit.	e.g. ms, kWh, ppm, lux, °, % (a max. of 3 characters)
■ Status value 4-byte		
Description	In this parameter, a free text (a maximum of 6 characters) can be entered	Free text (a maximum of 6 characters)
Number format	The format of the numerical values to be displayed is defined with this parameter.	Integer Floating-point number
4-Byte value, integer	The data type format of the value to be displayed is defined with this parameter.	0 ... 4294967295 * -2147483648 ... 2147483647
Decimal place	If the value "floating-point number" is selected, the number of decimal places must be set in this parameter.	0 *.. 2
Measuring unit ¹	In this parameter, a text not exceeding 3 characters in length can be entered as a measuring unit.	e.g. ms, kWh, ppm, lux, °, % (a max. of 3 characters)

Table 8: State of the house

i In „Table 10: Examples Status messages“, examples must be listed for individual status value types.

No.	Name	Object function	Length	Data type
9	Display	1 bit	1 bit	1.001 DPT_ON/OFF
10	Display	1 byte	1 byte	7.001 DPT_Counting pulse (0..255)
11	Display	2 byte	2 byte	7.001 DPT_Pulse
12	Display	4 byte	4 byte	12.001DPT_Counting pulses (unsigned)

¹ This parameter is visible if the checkmark for "Description of the measuring unit" is checked.

² This parameter is visible if the number format "floating-point number" is selected under value "2 or 4 byte".

* Default value

Options for configuration of the status message:

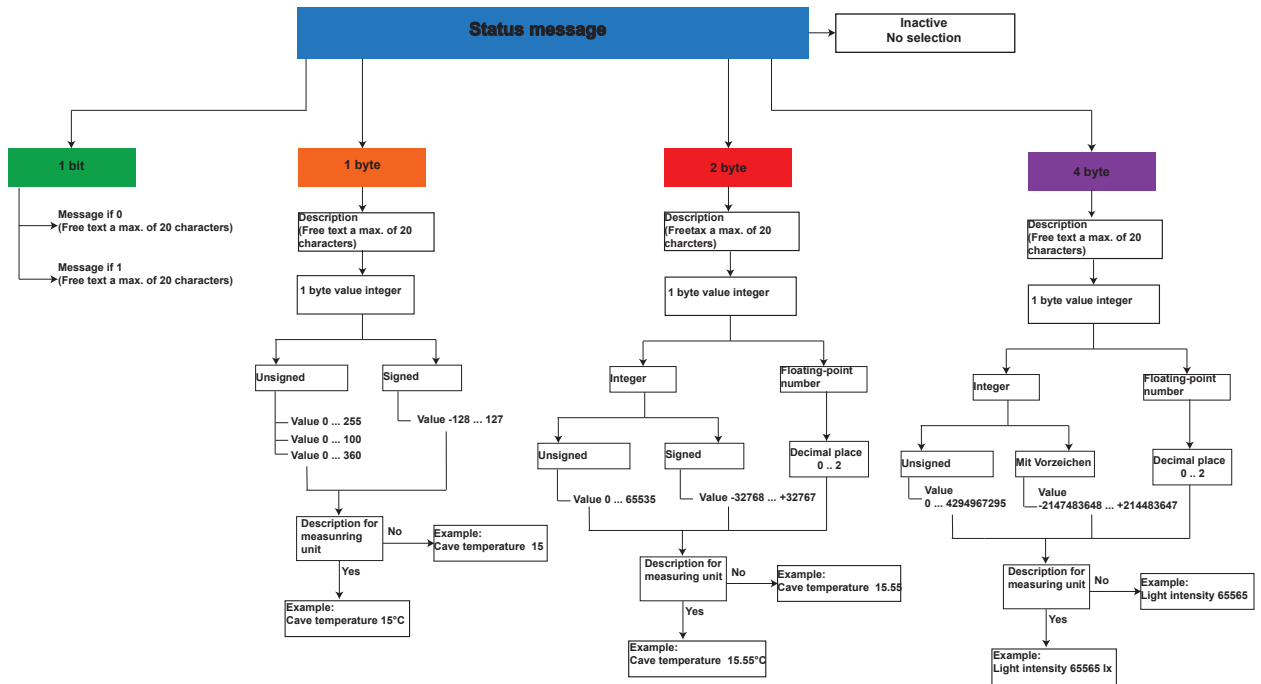

Figure 18: Overview "Configuration status message"

4.5.1 Page Status - messages

On the "Status" page, the current state of the parameterised devices, such as window contact request, status of the connected loads (energy [kWh], dew point operation, load shedding and the predefined user messages are displayed. The corresponding value display with unit can be assigned to the respective current status.

On the "Status" display page, a maximum of 3 status/user messages can be displayed simultaneously. The messages are displayed here by means of the priority list (Table 9).

Priority	Description
Priority 1 (highest priority)	State window contact
Priority 2	Status dew point alarm
Priority 3	Status load shedding
Priority 4 (lowest priority)	User message (max. 3)

Table 9: Priority Status message/User message

Application description

KNX thermostat
KNX room controller

Page Status → Display of the set status

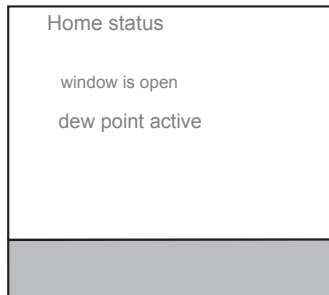

In the display, the status messages created in the ETS, such as "window open", are displayed.

Figure 19: Page Status messages

In Figure 19 two individually created status messages (window opened or dew point operation) are shown by way of example.

Status messagees				
	1-Bit switching	1-Byte value	2-Byte value	4-Byte value
Example	Frontdoor open	TV 100 W	Cooker 2.4 kWh	Light 200000 Lx
Description	Frontdoor open	TVs	Cooker	Light
Value	---	100	2.4	20000
Decimal place	---	---	1	0
Measuring unit	---	W	kWh	lx

Table 10: Examples Status messages

Application description

KNX thermostat
KNX room controller

4.6 Blocking function

In the following parameter window, the respective function and selection options of the "Blocking function" function are displayed. It is possible to lock all pages of the products by which the temperature control can be set or changed. To do this, the checkmark for "Block temperature control" (,1) must be checked and the blocking function enabled via the object 8.

In addition, the push-push-buttons 1-9 can be blocked for which the "blocking function" checkmark within the parameters of the "push-button x" must also be checked. If the blocking function is activated, the lock symbol appears in the display on all pages affected.

 Display → Blocking function

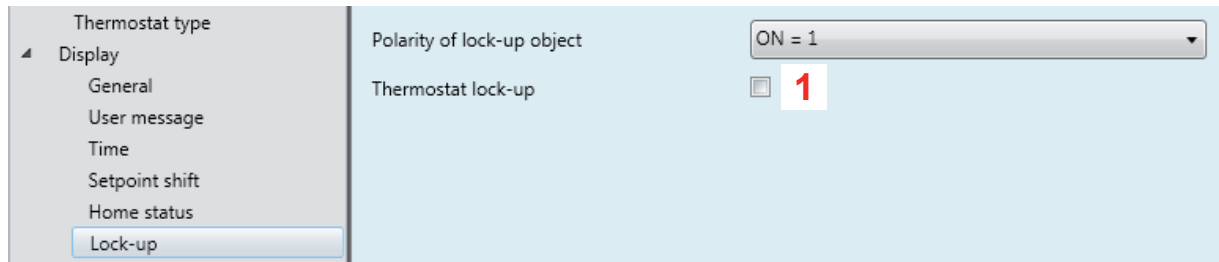

Figure 20: Blocking function

Parameters	Description	Value
Polarity of lock-up object	This parameter defines at which value the blocking function is activated.	ON = 1* ON = 0

Table 11: Blocking function

Communication object "Blocking function"

No.	Name	Object function	Length	Data type
8	Display	Blocking function	1 bit	1.001 DPT_ON/OFF

After bus voltage recovery, a lock-up remains active if it was activated before the bus voltage failed.

The polarity of the lock-up object can be parameterised.

* Default value

Application description

KNX thermostat
KNX room controller

4.7 Push-push-button

 The following parameter setting can only be selected on the device "KNX Room controller". A long push-push-button action, among other things, is required for the functions "Dimming (brighter/darker), shutter/blind (up/down) set temperature adjustment etc.

 Display → Push-push-button

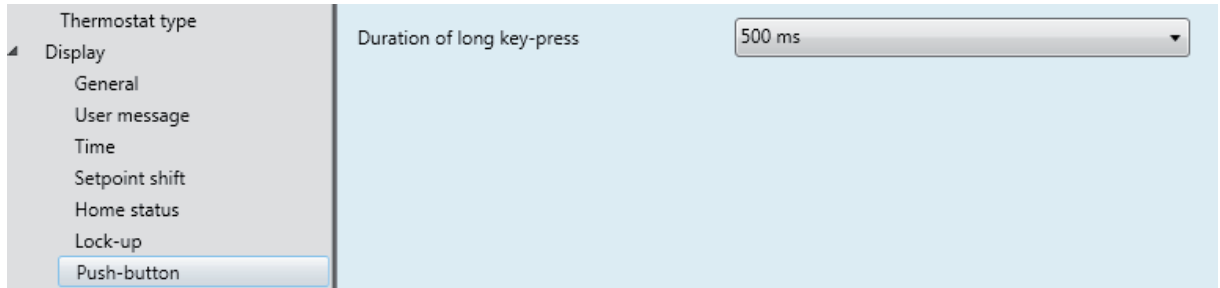

Figure 21: Time setting for long push-push-button action

Parameters	Description	Value
Time for long push-button-press	This parameter defines the moment from when a long push-push-button action is detected.	400 ms ... 500 ms *... 1s;

Table 12: Time setting for long push-push-button action

* Default value

Application description

KNX thermostat
KNX room controller



5. Room thermostats

In this section, the settings for the thermostat functions will be presented. Here, for example, the parameters of the heating system (convector heating, underfloor heating etc.) or the temperature setpoints for heating and/or cooling are set.

5.1 General

The parameter settings for the Room thermostat - General are to be set the same for both device variants (thermostat/room controller).

The function distinguishes between the mode selections "heating" and "cooling". The mode selections define whether the controller should control heating systems or cooling systems via its parameters. A mixed operation of heating and cooling is also possible, whereby the device controlled automatically via communication objects, switches between the heating and cooling mode selections.

Furthermore, the device has additional heating or cooling stages. With this two-stage control, separate command values are calculated and transmitted for the basic and additional stage depending on the set/actual temperature deviation.

Room thermostat → General → Mode selection

In the general settings, the mode selection of the heating and/or cooling system must first be set. The six different mode selections are shown in the following overview.

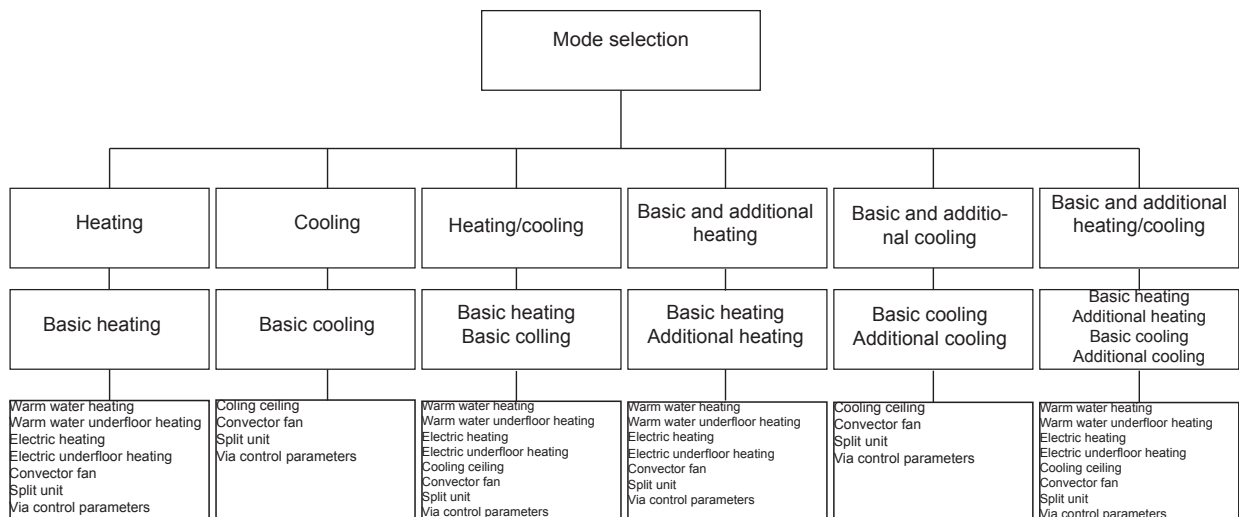

Figure 22: Overview heating/cooling variants

The corresponding parameter windows for configuration open depending on mode selection. Furthermore, the general settings, such as mode selection changeover, frost/heat protection, valve protection, presence detection, holiday mode and self-learning heating curve, have to be made.

Application description

KNX thermostat
KNX room controller



Figure 23: Settings “General - room thermostat”

Parameters	Description	Value
Mode selection ¹	The mode selection of the heating/cooling system is defined with this parameter.	Heating * Cooling Heating/Cooling Basic and additional heating Basic and additional cooling Basic and additional heating/cooling
Fan available	After activating the parameter (set checkmark), an additional parameter "Ventilation" becomes visible (Figure 23, 1). The settings for the ventilation are made in this parameter.	
Send heating and cooling command value to a common object ²	When using this parameter (checkmark is enabled by default (Figure 23, 2)), it is possible to transmit the "Heating/Cooling" command value to the bus as a common communication object.	
State after bus voltage failure	This parameter defines the mode selection which is to be switched on after a reset.	Comfort * Standby Night operation Frost/Heat protection State before failure
Mode selection changeover	This parameter defines the communication object type with which the change-over of the mode selection should take place.	Via value 1 byte * Via switching (4 x 1 bit) Via value (1 byte) and/or via switching (4 x 1 bit)

Application description

KNX thermostat
KNX room controller



Frost/heat protection	This parameter defines what triggers the frost/heat protection.	Automatic Frost/Heat protection Via window contact *
Frost/heat protection change-over delay	The change-over delay allows you to set the time that must elapse before the frost/heat protection mode is switched on.	0 * ... 255 min
Automatic ³	The automatic change-over sets the temperature change at which the change-over to frost/heat protection should take place per minute.	Off * 0.2 K/min ... 0.6 K/min
Heating/cooling-changeover	This parameter allows you to set how the change-over between heating and cooling should occur.	Via object * Automatic
Heating/Cooling operation after bus voltage failure	The mode selection that the heating/cooling system is set to after a rest or after a bus voltage failure is set here.	Heating Cooling Mode selection before reset *
Heating/Cooling - change-over delay	The delay time, after which time the change-over between heating and cooling occurs, is set here.	0 * ... 255 min

Table 13: Settings "General - Room thermostat"

¹ Depending on the value selection in the "mode selection" parameter, additional function parameters open for configuring the heating and/or cooling system.

² This parameter is only visible if the values "heating and cooling" or heating and cooling plus additional stages" are selected in the "mode selection" parameter.

³ This parameter is only visible if the value "Automatic Frost/Heat protection" is selected in the "Frost/Heat protection" parameter.

No.	Name	Object function	Length	Data type
13	Room thermostats	Mode selection changeover	1 byte	20.102 DPT_HVAC mode
14	Room thermostats	Comfort	1 bit	1.001 DPT_ON/OFF
15	Room thermostats	Standby	1 bit	1.001 DPT_ON/OFF
16	Room thermostats	Night lowering	1 bit	1.001 DPT_ON/OFF
17	Room thermostats	Frost/heat protection	1 bit	1.001 DPT_ON/OFF
18	Room thermostats	Mode selection changeover Automatic	1 byte	20.102 DPT_HVAC mode
22	Room thermostats	Window contact state	1 bit	1.019 DPT_Window/Door
86	Room thermostats	Presence	1 bit	1.001 DPT_ON/OFF
87	Room thermostats	Deactivation room thermostat	1 bit	1.003 DPT_Enable

* Default value

Application description

KNX thermostat
KNX room controller



Parameters	Description	Value
Deactivation room thermostat (Dew point operation)	With this parameter it is possible to stop the temperature control via object.	No * Via object
Polarity ⁴	This setting defines from which value 0/1 the deactivation takes place on the corresponding object.	On = 0* On = 1 *
Lock-up of additional stage	With this parameter it is possible to deactivate the thermostat.	No * Via object
Polarity ⁵	This setting defines from which value 0/1 the deactivation takes place on the corresponding object.	On = 0* On = 1 *
Valve protection	(Checkmark is disabled by default (Figure 23, 3)) This parameter is used, for example, to prevent calcification of the radiator valve.	
Time ⁶	This parameter sets the time when the valve protection should be performed.	0 * ... 23 h
Presence detection	This parameter allows you to set the way in which the comfort extension can be switched to.	Inactive Using presence push-button Using presence detector *
Comfort extension time	If "Using presence push-button or Using presence detector" is selected, the comfort extension time can be set here.	Inactive 1 s... 30 min * ... 24 h
Holiday mode - Selecting mode selection	The mode selection for holiday mode is selected with this parameter.	Holiday mode - Frost/Heat protection * Holiday mode standby Holiday mode night lowering
Holiday mode - Number of days	The number of holidays is set with this parameter. If holiday mode is activated, the thermostat runs the heating/cooling system in the holiday mode selection previously selected for the selected period.	1 * ... 99
Self-learning heating curve	(Checkmark is enabled by default (Figure 23, 4)) This parameter is used to set the room thermostat to a self-learning mode.	

Table 14: Settings "General - Room thermostat - Heating"

⁴ This parameter is only visible if the value "Via object" is selected "in the parameter "deactivation of thermostat".

⁵ This parameter is only visible if the value "Via object" is selected "in the parameter "Lock-up of additional stage".

⁶ This parameter is only visible if the checkmark is set to valve protection.

* Default value

Application description

KNX thermostat
KNX room controller

Valve protection

To prevent calcification or jamming of the activated radiator or cooling system control valves, a cyclical valve protection can be performed. The "valve protection" parameter in the parameter branch "General - Room thermostat" is deactivated by default (set checkmark Figure 23, 2).

This protection function is generally only started for inactive command value outputs, i.e. for outputs that have not requested any heating or cooling energy in the past 24 hours. The controller sets the command value for these outputs to the maximum value cyclically once a day at the selected hour for a period of approx. 5 minutes. Consequently, even valves that have been closed over long periods are briefly opened at regular intervals.

Presence detection

In order to activate the comfort extension, the presence push-button or presence detector can be activated additionally by the "presence detection" parameter. If activated, the "Room thermostat - presence" object appears. In this way, it is possible to switch to the comfort extension or to deactivate this again early by pressing the presence push-button through a presence detector activity.

Self-learning heating curve

If the checkmark is set (Figure 23, 3), the thermostat "learns" how long the lead time must be in order to reach the set room temperature at the respective time.

The "self-learning mode" may take some time depending on the heating/cooling habits.

5.2 Mode selection

The room temperature controller distinguishes various mode selections. Thus, for example, it is possible to activate different temperature setpoints depending on the presence of a person, the state of the heating or cooling system, depending on the the time of day or weekday by activating these modes.

Comfort operation

The comfort mode selection should be activated if people are in a room and for this reason the room temperature must be adjusted to a comfortable, appropriate value. The change-over to this mode selection can also be presence-controlled. An activated comfort mode selection is indicated in the display by the symbol "".

Standby operation

If a room is not used during the day because people are absent, the standby operation can be activated. Thus, the room temperature can be adjusted to a standby value and heating and cooling energy can be saved. An activated standby mode selection is indicated in the display by the symbol "".

Night operation

During nighttime hours or in cases of prolonged absence, it is usually advisable to adjust the room temperature (e.g. in bedrooms) of heating systems to cooler temperatures. In this case, cooling systems can be set to higher temperature values if an air-conditioning system is not necessary (e.g. in offices). The night operation can be activated for this purpose. An activated night operation is indicated in the display by the symbol "".

Application description

KNX thermostat
KNX room controller

Frost/heat protection mode

Frost protection is necessary if, for example, the room temperature must not fall below a critical value when the window is open. Heat protection may be necessary if the temperature becomes too high (mostly due to external influences of a constantly warm environment). In these cases, freezing or overheating of the room depending on the set mode selection "Cooling" or "Heating" can be prevented by activating the frost/heat protection or by specifying a separate temperature setpoint.

An activated frost/heat protection is indicated in the display by the symbol "".

Comfort extension (temporary comfort operation)

The comfort extension can be used to adjust the room to the comfort temperature for a certain time, for example, if the room is also 'used' during the night. Activation takes place by a parameterised presence push-button on the "basic display" page or by the presence object. The comfort extension is deactivated automatically once a definable time has elapsed by pressing the presence push-button again or by receiving a presence object value = "0". The extension cannot be triggered.

An activated comfort extension is indicated in the display by the symbol "".

A separate temperature setpoint can be predefined for each "Heating" or "Cooling" mode selection.

5.3 Mode selection changeover

The mode selections can be activated or changed over in various ways. An activation or change-over is possible by (with descending priority):

1. Deactivation room thermostat via object (Dew point operation) → Frost/Heat protection is activated
2. Priority object (2-bit) → forced mode comfort or frost/heat protection
3. Window contact → Automatic Frost/Heat protection
4. Holiday mode → Frost/Heat protection, night lowering, standby
5. Mode selection changeover on display
6. Switch mode selection via object no. 13 - 18
7. Comfort extension via presence object/push-button.

Mode selection changeover on display

The three mode selections comfort, standby and night operation are selected on the mode selection page.

Mode selection:

- Comfort (presence)
The Comfort mode selection sets the room temperature to a temperature value predefined in the thermostat e.g. comfort temperature 21°C for comfort (presence).
 - Standby (absence)
The Standby mode selection reduces the room temperature after leaving the room to a value predefined in the thermostat (19°C, for example).
 - Night operation
The night operation mode selection reduces the heating circuit temperature at night.
-  With underfloor heatings, the change-over from is only noticeable after a certain period of time due to the sluggishness of the underfloor heating system with each setpoint adjustment.

Mode selection menu

Application description

KNX thermostat
KNX room controller

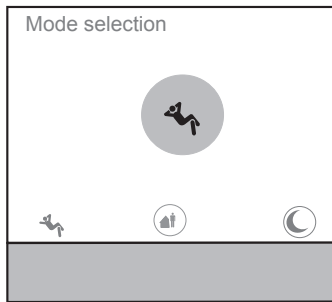

- On the mode selection page, select the required mode selection by pressing the touch control surface below the symbol.

The active mode selection is...

- displayed in the centre of the display highlighted in colour
- displayed without a border
- displayed in the status line of the basic display.

☺ Comfort (presence))

☹ Standby (absence)

☾ Night operation

Figure 24: Mode selection

The mode selections can be activated or changed over in various ways. An activation or change-over is possible by...

- an operation locally on the device using the touch control surface
- a switching time set locally on the device (timer)
- the communication objects available separately for each mode selection or by the KONNEX objects

The individual options for the mode selection changeover are described in detail below.

Change-over of the mode selection via the internal timer

The switch-on or switch-off times can be set on the "Timer" page for the mode selections "comfort", "standby" or "night operation". The switching times can optionally be parameterised for each weekday or for sections of the week.

i The timer can be set **only on the device**.

More information can be found in the section "Timer page".

Change-over of the mode selection via communication objects

A distinction is made as to whether the mode selection change-over should take place via separate 1-bit objects, four 1-bit objects or alternatively via the 1-byte KONNEX objects. The "mode selection changeover" parameter in the "Room thermostat - General" parameter branch defines the change-over method.

Application description

KNX thermostat
KNX room controller

The mode selection change-over via "Switching" (4 x 1 bit):

There is a separate 1-bit change-over object for each mode selection. It is possible to changeover or specify the current mode selection through each of these objects depending on priority.

Taking the priority into account results in the following changeover hierarchy during an mode selection change-over whereby a distinction is made between presence detection by a presence push-button (Table 15/Figure 25) and a presence detector (Table 16/Figure 26):

Objects mode selection change-over				Window status	Presence push-button object	Active operating-mode
X	X	X	X	1	X	Frost/heat protection
1	X	X	X	0	0	Frost/heat protection
0	1	X	X	0	0	Comfort
0	0	1	X	0	0	Standby
0	0	0	1	0	0	Night operation
1	X	X	X	0	1	Comfort extension
0	1	X	X	0	1	Comfort
0	0	1	X	0	1	Comfort
0	0	0	1	0	1	Comfort extension
0	0	0	0	0	0	Last valid mode set
0	0	0	0	0	1	Comfort/Comfort extension

Table 15: Mode selection change-over via object with presence object

X = irrelevant

*: Depending on the last valid mode selection set

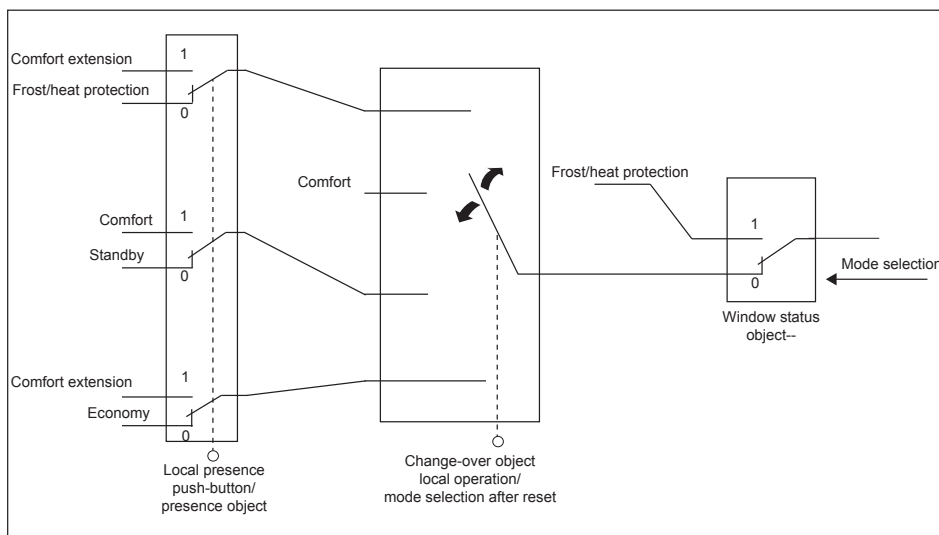

Figure 25: Overview diagram "Mode selection change-over via object with presence object" (4x1 bit)

Application description

KNX thermostat
KNX room controller





Objects mode selection change-over				Window status	Presence detector object	Active operating-mode
						
X	X	X	X	1	X	Frost/heat protection
X	X	X	X	0	1	Comfort
1	X	X	X	0	0	Frost/heat protection
0	1	X	X	0	0	Comfort
0	0	1	X	0	0	Standby
0	0	0	1	0	0	Night operation
0	0	0	0	0	0	Last valid mode set

Table 16: Mode selection change-over via object with presence object with presence detector

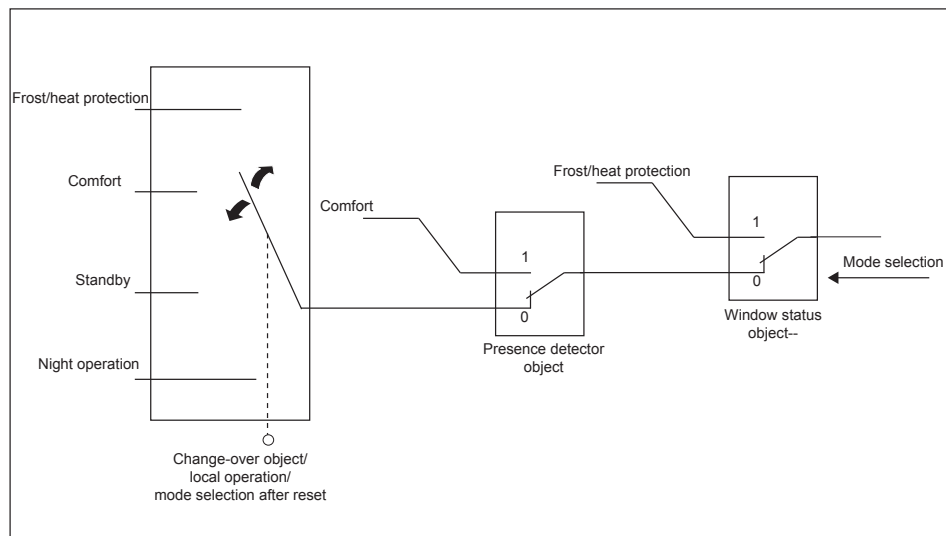

Figure 26: Overview diagram "Mode selection change-over via object with presence detector" (4x1bit)

Application description

KNX thermostat
KNX room controller



Mode selection change-over via "Value" (1 byte)

There are two 1-byte change-over objects for all mode selections, namely no. 13 and 18. A command for changing over the mode selection, e.g. from a central clock, is sent to the object no. 18. At the same time, the mode selection can be changed via the object no. 13, e.g. by a push-push-button. During running time, the change-over of the mode selection can take place immediately via this value object after receipt of just one telegram. In the course of this, the received value defines the mode selection.

1-Byte object mode selection change-over	2-Bit priority object Mode selection		Window status	Presence push-button object	Active operating-mode
X	1	0	X	X	Frost/heat protection
X	1	1	X	X	Comfort
01	0	X	0	0	Comfort
02	0	X	0	0	Standby
03	0	X	0	0	Night-time temperature reduction
04	0	X	0	0	Frost/heat protection

Table 17: Mode selection switch-over via object (1 byte) with priority of 2-bit object

5.3.1 Notes on mode selections

Presence function / Comfort extension

The device can switch to comfort operation by a mode presence detection in the event of a movement. The "presence detection" and "Via presence detector" parameters in the "Room thermostat → General" parameter branch define here whether the presence detection takes place movement-controlled by a presence detector.

Presence detection by presence push-button:

If the presence push-button is activated, object 86 "presence object" is visible. Thus, if standby or night operation is activated, it is possible to switch to the comfort extension by a presence object value = "1". The extension is deactivated automatically once the parameterised "comfort extension time" has elapsed. A comfort extension can be deactivated early if the object has received a value = "0". It is not possible to retrigger the extension time.

If the duration of the comfort extension is set to "inactive", no comfort extension can be activated from the standby or night operation. In this case, the mode selection is not changed even though the presence function is activated.

The presence object or presence function is always deleted during a change-over to another mode selection or after deactivation of a priority mode (with KONNEX priority change-over). A presence function activated before a reset incl. object is always deleted after a reset.

Presence detection by presence detector

If a presence detector is activated as the presence detection type, the object 86 "presence object" is visible. Presence detectors can also be integrated into the room temperature control via this object. If a movement is detected ("1 - telegram), the controller switches to comfort operation. Another mode selection can still be selected.

After the delay time in the presence detector has elapsed ("0" - telegram), the controller switches back to the mode that was active before the presence detection.

A presence function activated before a reset is always deleted after a reset. In this case, the presence detector must transmit a new "1" telegram to activate the presence function.

Application description

KNX thermostat
KNX room controller

Window status / Automatic frost protection control:

The devices have various options for switching to the frost/heat protection. Besides the change-over by the corresponding mode selection change-over object or by the holiday mode on the device, the frost/heat protection can be activated by a window contact, or alternatively, by an automatic temperature control of the frost protection. Among these options, the window contact or automatic control has the higher priority. The "frost/heat protection" parameter in the "Room thermostat - General" parameter branch defines how the higher change-over takes place according to priority:

Frost/Heat protection change-over "Via window contact":

Object 22 "Window contact state" is activated. A telegram with the value "1" (opened window) activates the frost/heat protection on this object. If this is the case, this mode selection cannot be deactivated by a local operation nor via the change-over object (with the exception of the KONNEX priority object).

The window status is first reset and the frost/heat protection deactivated with the value = "0" (closed window). After that, the tracked mode selection set before opening the window or during the opened window is activated via the bus.

A delay of the window status can be parameterised optionally. This delay can be useful if the room only needs to be ventilated briefly by opening the window and should not cause any changeover of the mode selection. The delay time is set by the "frost/heat protection change-over delay" and can be between 1 and 255 minutes. The window status and the the frost/heat protection is first activated after the parameterised time has elapsed. The "0" setting causes the immediate activation of the frost/heat protection on the opened window. The window status is effective in heating and in cooling operation. The "window contact state" object is deleted ("0") after a reset.

Frost protection change-over by "Automatic Frost/Heat protection":

With this setting, it is possible to change over automatically to the frost protection temporarily depending on the determined room temperature. If no window contacts are available, this setting can prevent the room from cooling down or heating up unnecessarily if windows or outside doors are opened.

With this function a rapid temperature drop can be detected by measuring the actual temperature, as caused by an opened window, for example.

If the detected reduction reaches a parameterised value, the room thermostat changes over automatically to frost protection. The "Automatic" parameter defines the maximum temperature drop for the frost protection change-over in °C/min. Once the time predefined by the "automatic frost protection time operation" parameter has elapsed, the controller switches back to the mode selection set prior to the frost protection.

If a change-over took place via the objects (4 x 1 bit or 1 byte) during the frost protection and a new mode selection was received, this tracked mode is set after the automatic frost protection.

- i** The KONNEX priority object has a higher priority than the automatic frost protection control and can interrupt this.

The automatic frost protection control has the same priority during an mode selection change-over in comparison with the alternative setting of the frost/heat protection detection by the window contact!

Application description

KNX thermostat
KNX room controller



Notice:

In the case of frequent draughts in a room, this can cause unwanted activation/deactivation of the frost protection if the automatic frost protection control is activated and the parameterised reduction is too low. The change-over to frost/heat protection by window contacts of the automatic control are generally preferable!

Mode selection after reset

In the "Room thermostat - General" parameter branch, it is possible to predefine which mode selection should be activated after bus voltage recovery or after a programming process by the ETS via the parameter "State after reset". The following settings are possible here:

- "Comfort": After the initialization phase, the comfort operation is activated.
- "Standby": After the initialization phase, the standby operation is activated.
- "Night": After the initialization phase, the night operation is activated.
- "Frost/heat protection": After the initialization phase, the frost/heat protection is activated.
- "State after reset": The mode activated prior to a reset is set again after the initialisation phase of the device.

A presence function activated before the reset incl. object is deleted after a reset.

Application description

KNX thermostat
KNX room controller

5.3.2 Holiday mode

The holiday mode prevents heating/cooling during a long absence in order to save energy costs and to protect the environment. In the course of this, the number of days are first set on the holiday mode page and then the mode selection that should solely be active during this period.

If holiday mode is switched on, a suitcase symbol is displayed, the function of the timer is cancelled and any changes to the mode selection via the bus are not implemented. You can choose between three mode selections:

- Standby
 - Night operation (Economy)
 - Frost/heat protection mode
- Page Holiday mode

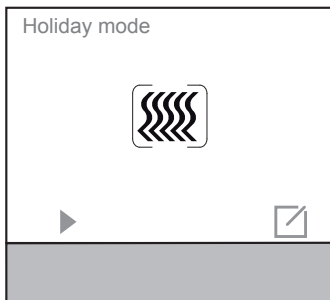

- On the holiday mode page, start the automatic control of the holiday mode with ▶.

OR:

- on the holiday mode page, confirm the control surface ☑.
The menu switches to the Select mode selection menu.



- On the holiday mode – mode selection page, select the required mode selection for the planned absence by pressing the touch control surface below the symbols.

View switches.

- ☑ Standby
- ☑ Night operation (Economy)

Heat protection mode

Frost protection mode

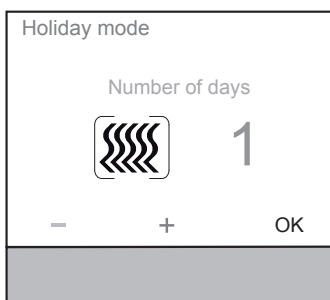

- Use the + / - buttons to set the number of days of the absence.

- Confirm with **OK**.

View switches.

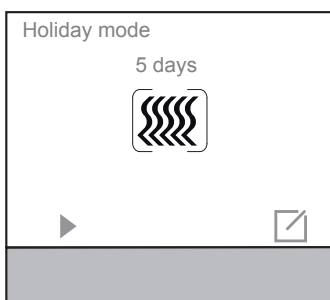

- On the holiday mode page, start the holiday mode with ▶.

Menu switches.

Application description

KNX thermostat
KNX room controller



- On the holiday mode page, stop the holiday mode with ■.
- The menu switches as shown in the previous figure.

Figure 27: Holiday mode

5.3.3 Transmission of set temperature

The setpoints for the heating and cooling predefined or subsequently adjusted by the active mode selections can be transmitted via the bus. The 8-byte objects 79 "Status setpoints heating" and 84 "Status setpoints cooling" are available for this purpose. These include the setpoints for all four mode selections Comfort, Standby, Night and Frost/heat protection. Each for the heating and cooling. Additionally, the 2-byte object 75, 76, 77 and 78 for heating and the objects 80, 81, 82 and 83 for cooling are provided as setpoint status of the four mode selections.

The setpoints are transmitted immediately after the programming, after a reset and during each change of the setpoint.

5.4 Mode selections and mode selections changeover

The device knows up to two mode selections. These mode selections define whether the controller should control heating systems (individual mode selection "heating") or cooling systems (individual mode selection "cooling") via its command value. It is also possible to activate a mixed operation whereby the controller can change-over between "heating" and "cooling" automatically or, alternatively, object-controlled.

Furthermore, the standard operation can be executed in two stages for controlling an additional heating or cooling unit. With two-stage control, separate command values are calculated and transmitted to the bus for the basic and additional stage depending on the set/actual temperature deviation.

The "mode selection" parameter in the "Room thermostat - General" parameter branch defines here the mode selection to be executed and activates the additional stage(s) if necessary.

In the individual mode selections "Heating" or "Cooling" without any additional stage, the controller always works with just one command value, alternatively with an activated additional stage, the controller works with two command values in the parameterised mode selection. Depending on the determined room temperature and predefined set temperatures of the mode selections, the room thermostat decides autonomously whether heating or cooling energy is required and calculates the command value for the heating or cooling system.

During "Heating" or "Cooling", the controller is always in the predefined mode selection after a reset (bus voltage recovery or reprogramming by the ETS).

In the "Heating and Cooling" mixed operation mode, the controller is able to control heating and cooling systems. The change-over behaviour of the mode selection can be predefined here:

- The "Heating/cooling-changeover" parameter in the "Room thermostat - General" parameter branch is set to "Automatic":

In this case, a heating or cooling operation is activated automatically depending on the determined room temperature and predefined temperature setpoint. If the room temperature is within the set dead zone, the room is neither heated nor cooled (both command values = "0"). When the display is pressed, the last active temperature setpoint for heating and cooling is displayed here. If the room temperature is greater than the

Application description

KNX thermostat
KNX room controller



temperature setpoint for cooling, the room is cooled. If the room temperature is less than the temperature setpoint for cooling, the room is heated.

If the change-over of the mode selection is automatic, the information about the object 20 "Heating/cooling-changeover" regarding whether the controller is working in heating operation ("1" - telegram) or in cooling operation ("0" - telegram) can be output actively to the bus.

Note on automatic change-over of the mode selection:

i If the same setpoints are used for heating and cooling in the respective mode selection, the resulting dead zone is very small. This may result in a constant change-over between heating and cooling. For this reason, the setpoints must be selected with care and should be based on the values entered previously.

- The "Heating/cooling-changeover" parameter in the "Room thermostat - General" parameter branch is set to "Via object":

In this case, the mode selection is controlled via object 20 "Heating/Cooling - Change-over". This type of change-over could be required, for example, if it is necessary to heat and cool using a one-pipe system (combined heating and cooling system). For this purpose, the temperature of the medium in the one-pipe system must first be changed by the system control.

Afterwards, the mode selection is set via the object (cooling in the summer often takes place in a one-pipe system with cold water, and in the winter heating often takes place with hot water).

The "Heating/cooling - changeover" has the following priority:

„1“: Heating; „0“: Cooling.

After a reset, the object value is "0" and the "heating/cooling operation after reset" is activated.

With the "heating/cooling operation after reset" parameter it is possible to define which mode selection is activated after a reset. With the "Heating" or "Cooling" settings, the controller activates the parameterised mode selection immediately after the initialisation phase. With the "Mode selection before reset" parameterisation, the mode selection set prior to the reset is activated. During a change-over via the object mode selection, the system first changes to the mode selection predefined after the reset. The system will first possibly change over to the other mode selection when the device receives an object update.

Application description

KNX thermostat
KNX room controller



5.5 Basic heating

In the "Basic heating" menu, the parameters must be set for the heating control, type of heating and its additional parameters.

The controller switches on the heating during heating operation once the room temperature falls below the setpoint and any possible defined hysteresis. During heating operation, the control switches the heating off once the set temperature of the current mode selection is reached.

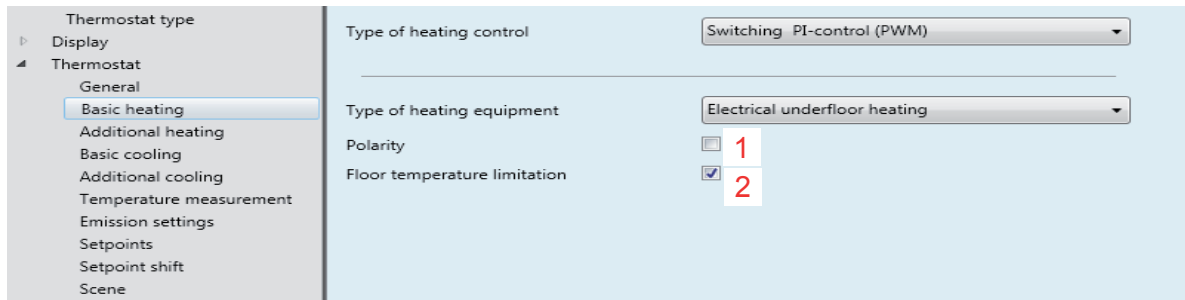

Figure 28: Room thermostat - Basic heating

Parameters	Description	Value
Type of heating control	This parameter selects the type of the heating control	Continuous PI control * Switching PI control (PWM) * Switching 2-point control
Hysteresis ¹	Definition of the temperature hysteresis for switching the heating on and off.	+0.3 ... +0.5 * ... +3.0 °C
Hysteresis time ¹	Defines the parameter for the hysteresis time.	Inactive 1 ... 5 * ... 10 min
Type of heating	This parameter selects the heating type.	Warm water heating * Warm water underfloor heating Electric heating Electric underfloor heating Convactor fan Split unit Via control parameters
Underfloor heating temperature limit ²	(Checkmark is enabled by default (Figure 28, 2)) This parameter is used to limit the floor temperature.	
Fan is also used for heating	(Checkmark is disabled by default). This parameter is only visible if the "Fan available" checkmark in the "General" parameter is enabled. Thus, any connected fan can be used for heating support.	
Cycle time ^{3 4}	The cycle time setting makes it possible to adapt the control to the drives that are used. The cycle time defines the switching sequence of the pulse modulated signal and allows adjustment to the adjustment cycle times of the actuators used (Travel time that the drive needs for adjusting the valve from the fully closed position to the fully opened position).	5 min ... 10 min * ... 1h 30 min
Proportional range ³	Defines the proportional range of the control loop (proportional coefficient).	0.5°C - 3,0°C * ... 6.0°C
Integration time ³	Defines the integration time (I proportion).	Inactive 15 min ... 30 min * ... 4 h

Application description

KNX thermostat
KNX room controller



Differential time ³	Defines the differential time (D proportion).	Inactive 15 min ... 30 min * ... 4 h
Polarity ⁵	(Checkmark is disabled by default (Figure 24, 1)). This parameter is used to adapt the control to the corresponding valve drives.	

Table 18: Room thermostat - Basic heating

¹ These parameters are only visible when the value "Switching 2-point control" is selected under "Type of heating".

² This parameter is only visible when the values "Underfloor heating" or "Electrical underfloor heating" are selected under "Type of heating control".

³ These parameters are only visible when the value "Via control parameters" is selected under "Type of heating control".

⁴ These parameters are only visible when the value "Via control parameters" is selected under "Type of heating control" and the value "Switching PI control (PWM)" is selected under "Type of heating".

⁵ This parameter is only visible when the value "Switching PI control (PWM)" or "Switching 2-point control" is selected under "Type of heating".

No.	Name	Object function	Length	Data type
32	Room thermostat	Switching	1 bit	1.001 DPT_ON/OFF
33	Room thermostat	Valve position in %	1 byte	5.001 DPT_Percentage (0-100 %)

 If the "Type of heating control via control parameters" occurs, knowledge of heating/ventilation/control technology should exist.

Application description

KNX thermostat
KNX room controller



5.6 Additional heating

The parameters for the additional heating are only visible if the function basic heating and additional heating or basic heating and additional heating/cooling is selected.

General → Mode selection → Basic heating and additional heating

or

General → Mode selection → Basic heating and additional heating/cooling

Depending on the selection under "Type of heating control" and "Type of heating", additional parameters open for setting the "Additional heating" function.

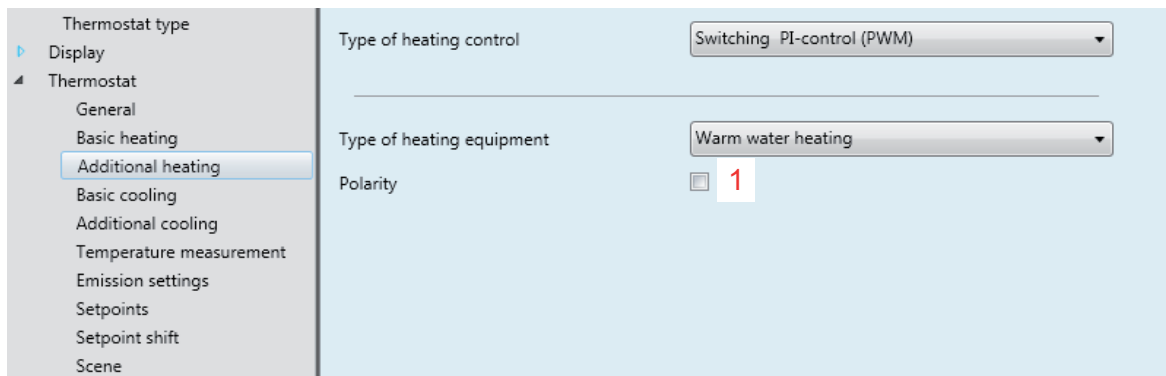

Figure 29: Room thermostat - Additional heating

Parameters	Description	Value
Type of heating control	This parameter selects the type of the heating control	Continuous PI control * Switching PI control (PWM) * Switching 2-point control
Type of heating	This parameter selects the heating type.	Warm water heating * Warm water underfloor heating Electric heating Electric underfloor heating Convactor fan Split unit Via control parameters
Underfloor heating temperature limit ²	(Checkmark is enabled by default. This parameter is used to limit the floor temperature.	
Hysteresis ¹	Definition of the temperature hysteresis for switching the heating on and off.	+0.3 ... +0.5 * ... +3.0 °C
Hysteresis (time) ¹	Defines the parameter for the hysteresis time.	Inactive 1 ... 5 * ... 10 min
Cycle time ²	The cycle time setting makes it possible to adapt the control to the drives that are used. The cycle time defines the switching sequence of the pulse modulated signal and allows adjustment to the adjustment cycle times of the actuators used (Travel time that the drive needs for adjusting the valve from the fully closed position to the fully opened position).	5 min ... 10 min * ... 1h 30 min
Proportional range ²	Defines the proportional range of the control loop (proportional coefficient).	0.5°C - 3,0°C * ... 6.0°C
Integration time ²	Defines the integration time (I proportion).	Inactive 15 min ... 30 min * ... 4 h

Application description

KNX thermostat
KNX room controller



Differential time ²	Defines the differential time (D proportion).	Inactive 15 min ... 30 min * ... 4 h
Polarity	(Checkmark is disabled by default (Figure 25, 1)). This parameter is used to adapt the control to the corresponding valve drives.	

Table 19: Room thermostat - Additional heating

¹ These parameters are only visible when the value "Switching 2-point control" is selected under "Type of heating".

² These parameters are only visible when the value "Via control parameters" is selected under "Type of heating control".

5.7 Setpoint heating on display

On the display, the temperature setpoints are set for the Comfort, Standby and Night lowering mode selections.

Settings page → Setpoint heating → Selecting mode selection

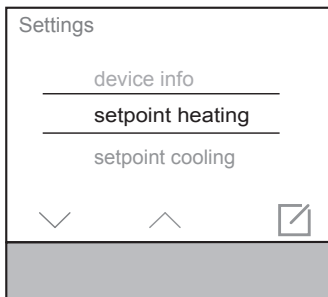

On the Settings page, select the "Setpoint heating" parameter using the arrow buttons \wedge / \vee and confirm with .

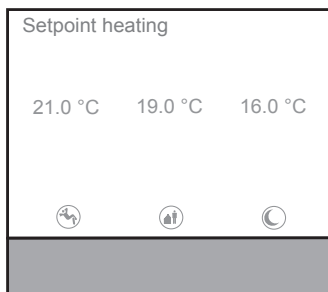

Under "Setpoint heating" select the mode selection whose assigned temperature setpoint should be changed. Night mode as an example.

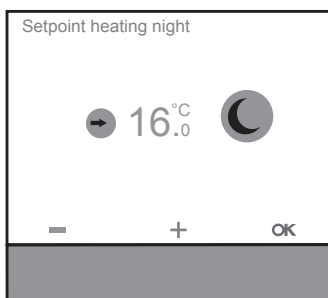

In the "Setpoint night heating" parameter, set the temperature setpoint using the + / - buttons and then confirm with **OK**.

Figure 30: Setpoint heating, mode selection night

* Default value

Application description

KNX thermostat
KNX room controller



5.8 Basic cooling

In the "Basic cooling" menu, the parameters must be set for the cooling control, type of cooling and its additional parameters.

The controller switches on the cooling during cooling operation once the room temperature rises above the setpoint and any possible defined hysteresis. During cooling operation, the control switches the cooling off once the set temperature of the current mode selection is reached.

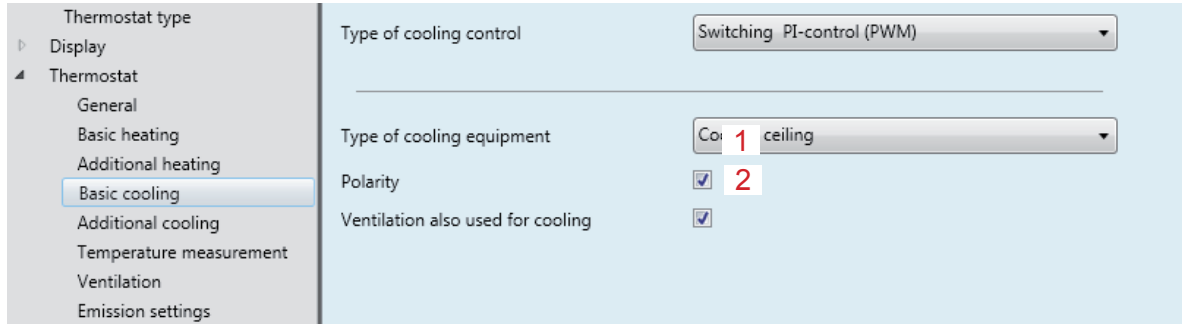

Figure 31: Room thermostat - Basic cooling

Parameters	Description	Value
Type of cooling control	The type of control is selected with this parameter.	Continuous PI control * Switching PI control (PWM) * Switching 2-point control
Hysteresis ¹	Definition of the temperature hysteresis for switching the heating on and off.	+0.3 ... +0.5 * ... +3.0 °C
Hysteresis time ¹	Defines the parameter for the hysteresis time.	Inactive 1 ... 5 * ... 10 min
Type of cooling	This parameter selects the cooling type.	Cooling ceiling * Convector fan Split unit Via control parameters
Fan is also used for cooling	(Checkmark is disabled by default (Figure 31, 2)). This parameter is only visible if the "Fan available" checkmark in the "General" parameter is enabled. Thus, any connected fan can be used for cooling support.	
Cycle time ^{2 3}	The cycle time setting makes it possible to adapt the control to the drives that are used. The cycle time defines the switching sequence of the pulse modulated signal and allows adjustment to the adjustment cycle times of the actuators used (Travel time that the drive needs for adjusting the valve from the fully closed position to the fully opened position).	5 min ... 10 min * ... 1h 30 min
Proportional range ²	Defines the proportional range of the control loop (proportional coefficient).	0.5°C - 3,0°C * ... 6.0°C
Integration time ²	Defines the integration time (I proportion).	Inactive 15 min ... 30 min * ... 4 h
Differential time ²	Defines the differential time (D proportion).	Inactive 15 min ... 30 min * ... 4 h
Polarity ⁴	(Checkmark is disabled by default (Figure 31, 1)). This parameter is used to adapt the control to the corresponding valve drives.	

Table 20: Room thermostat - Basic cooling

Application description

KNX thermostat
KNX room controller



¹ These parameters are only visible when the value "Switching 2-point control" is selected under "Type of cooling" .

² These parameters are only visible when the value "Via control parameters" is selected under "Type of cooling control" .

³ These parameters are only visible when the value "Via control parameters" is selected under "Type of cooling control" and the value "Switching PI control (PWM)" is selected under "Type of heating".

⁴ This parameter is only visible when the value "Switching PI control (PWM)" or "Switching 2-point control" is selected under "Type of cooling" .

No.	Name	Object function	Length	Data type
32	Room thermostat	Switching	1 bit	1.001 DPT_ON/OFF
37	Room thermostat	Valve position in %	1 byte	5.001 DPT_Percentage (0-100 %)

- i** If the "Type of cooling control via control parameters" occurs, knowledge of heating/ventilation/control technology should exist.

Application description

KNX thermostat
KNX room controller



5.9 Additional cooling

The parameters for the additional cooling are only visible if the function basic cooling and additional cooling or basic heating and additional heating/cooling is selected.

General → Mode selection → Basic cooling and additional cooling

or

General → Mode selection → Basic heating and additional heating/cooling

Depending on the selection under "Type of cooling control" and "Type of cooling", additional parameters open for setting the "Additional cooling" function.

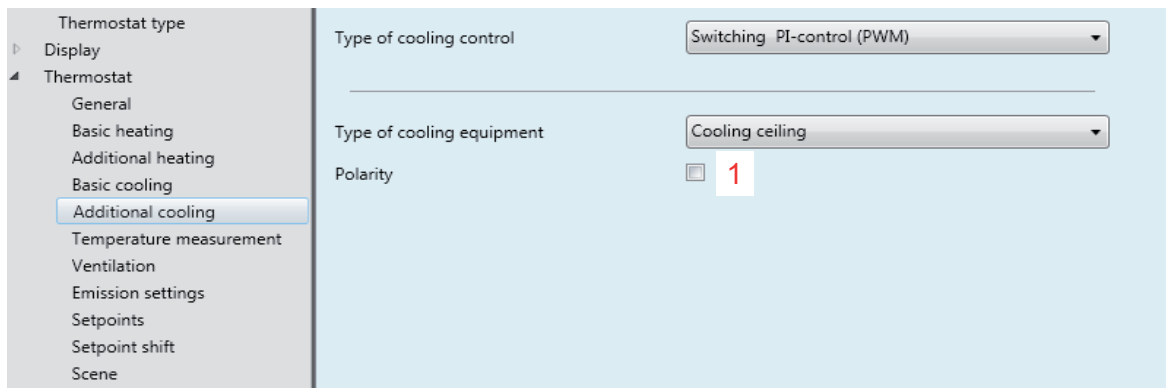

Figure 32: Room thermostat - Additional cooling

Parameters	Description	Value
Type of cooling control	This parameter selects the type of the heating control	Continuous PI control * Switching PI control (PWM) * Switching 2-point control
Type of cooling	This parameter selects the heating type.	Cooling ceiling * Convector fan Split unit Via control parameters
Hysteresis ¹	Definition of the temperature hysteresis for switching the heating on and off.	+0.3 ... +0.5 * ... +3.0 °C
Hysteresis (reset time) ¹	defines the parameter for the reset time.	Inactive 1 ... 5 * ... 10 min
Cycle time ²	The cycle time setting makes it possible to adapt the control to the drives that are used. The cycle time defines the switching sequence of the pulse modulated signal and allows adjustment to the adjustment cycle times of the actuators used (Travel time that the drive needs for adjusting the valve from the fully closed position to the fully opened position).	5 min ... 10 min * ... 1h 30 min
Proportional range ²	Defines the proportional range of the control loop (proportional coefficient).	0.5°C - 3,0°C * ... 6.0°C
Integration time ²	Defines the integration time (I proportion).	Inactive 15 min ... 30 min * ... 4 h
Differential time ²	Defines the differential time (D proportion).	Inactive 15 min ... 30 min * ... 4 h

Application description

KNX thermostat
KNX room controller



Polarity	(Checkmark is disabled by default(Figure 32, 1)) This parameter is used to adapt the control to the corresponding valve drives.
----------	---

Table 21: Room thermostat - Additional cooling

¹ These parameters are only visible when the value "Switching 2-point control" is selected under "Type of cooling" .

² These parameters are only visible when the value "Via control parameters" is selected under "Type of cooling control" .

5.10 Setpoint cooling on display

Settings page → Setpoint heating → Selecting mode selection

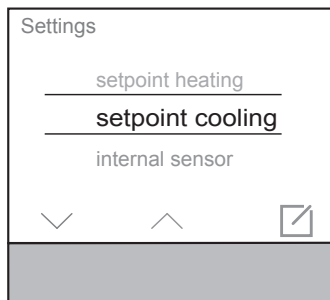

On the Settings page, select the "Setpoint cooling" parameter using the arrow buttons \wedge / \vee and confirm with

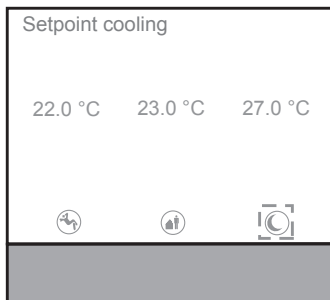

Under "Setpoint cooling" select the mode selection whose assigned temperature setpoint "Cooling" should be changed. Night mode as an example.

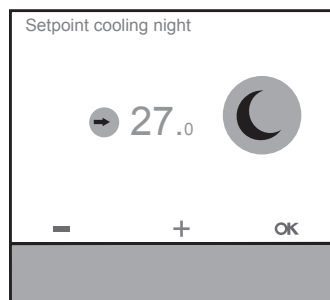

In the "Setpoint night cooling" parameter, set the temperature setpoint using the + / - buttons and then confirm with **OK**.

Figure 33: Setpoint cooling, mode selection Night



* Default value

Application description



KNX thermostat
KNX room controller

5.11 Heating or cooling mode

In the Heating/cooling operation menu, the type of control for heating or cooling can be changed.

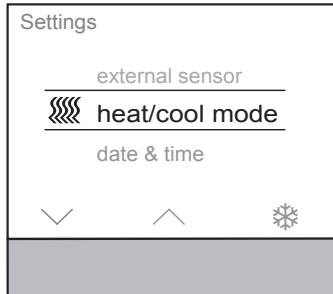
- Settings page → Heating/cooling operation → Heating operation  / Cooling operation 



- On the Settings page, select the "heating/cooling operation" parameter using the arrow buttons  / .
The device is in heating operation

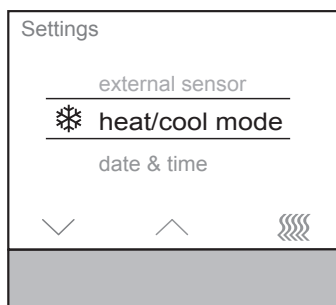

- Press the touch control surface below .
Switch to cooling operation.
The device is in cooling mode.

Figure 34: Heating or cooling mode

- i** If the "Automatic change-over between heating and cooling" was selected in the ETS, this menu item is hidden!

Application description

KNX thermostat
KNX room controller

5.12 Temperature measurement

The room thermostat measures the actual temperature and compares this with the predefined set temperature. The command value is calculated from the difference between the actual and set temperature by means of the set control algorithm.



These settings can only be made in the ETS.



Room thermostat → Temperature measurement

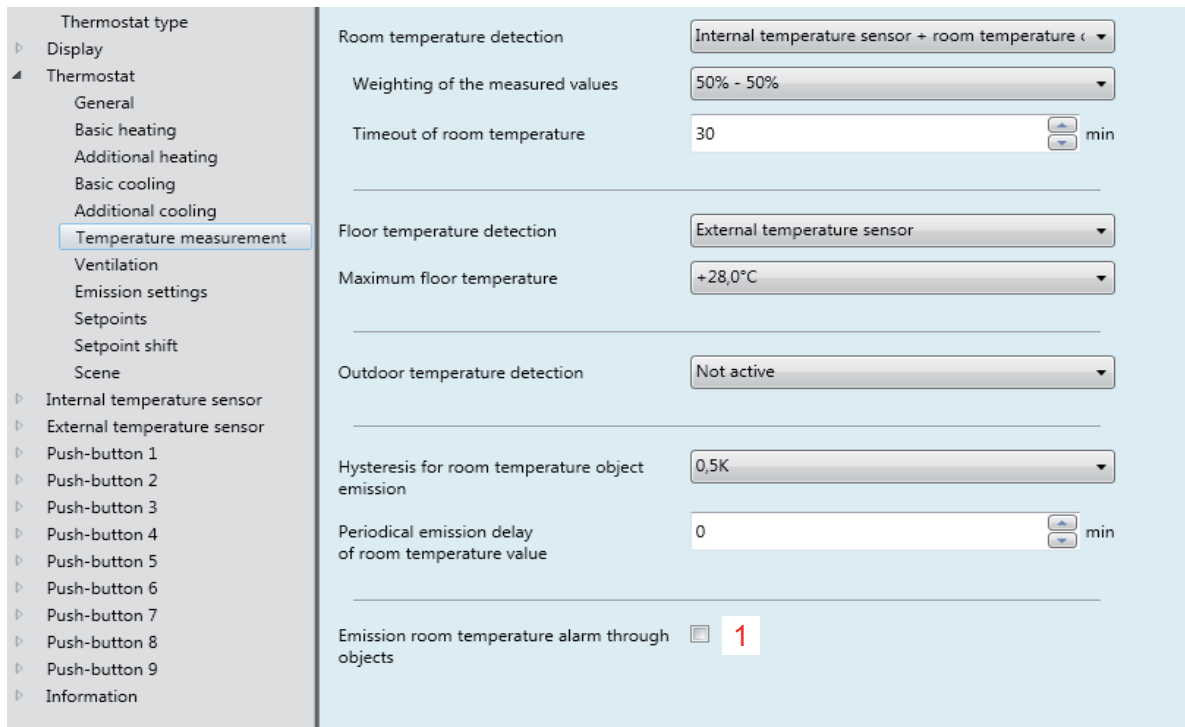

The screenshot displays the configuration interface for a room thermostat's temperature measurement settings. On the left is a navigation tree with the following items: Thermostat type, Display, Thermostat (expanded), General, Basic heating, Additional heating, Basic cooling, Additional cooling, Temperature measurement (highlighted), Ventilation, Emission settings, Setpoints, Setpoint shift, Scene, Internal temperature sensor, External temperature sensor, Push-button 1-9, and Information. The main panel on the right contains the following settings:

- Room temperature detection: Internal temperature sensor + room temperature
- Weighting of the measured values: 50% - 50%
- Timeout of room temperature: 30 min
- Floor temperature detection: External temperature sensor
- Maximum floor temperature: +28,0°C
- Outdoor temperature detection: Not active
- Hysteresis for room temperature object emission: 0,5K
- Periodical emission delay of room temperature value: 0 min
- Emission room temperature alarm through objects: 1

Figure 35: Temperature measurement settings

Application description

KNX thermostat
KNX room controller



Parameters	Description	Value
Room temperature detection	<p>Defines which sensor is used for room temperature control of the control circuit.</p> <p>Internal sensor: Built-in sensor in the device.</p> <p>External sensor: An additional external sensor attached to the device, e.g. under difficult measuring conditions (swimming pool or similar.).</p> <p>Internal and external sensor: Both sensors are used, e.g. in large rooms.</p> <p>Room temperature object: The measured room temperature is provided via the bus. E.g. via a push-push-button.</p>	<p>Internal temperature sensor and room temperature object *</p> <p>Internal temperature sensor Only via external temperature sensor Via object External sensor + object</p>
Weighting of the measured values ¹	<p>Defines the weighting of the temperature measurement as soon as two sources are used for measuring the temperature. Thus, a resulting total measured value is calculated, which is used for further evaluation of the room temperature.</p>	<p>10 % - 90 % 20 % - 80 % 30 % - 70 % 40 % - 60 % 50 % - 50 % * 60 % - 40 % 70 % - 30 % 80 % - 20 % 90 % - 10 %</p>
Timeout room temperature object ²	<p>If no temperature value is received during the temperature measurement "via object", then an error message appears in the display after a set time.</p>	<p>0 ... 30 *... 255 min</p>
Floor temperature detection	<p>Defines the type of floor temperature detection.</p> <p>Ext. temperature sensor: Temperature sensor is connected to the device.</p> <p>Via object: Temperature value is provided via the bus.</p>	<p>Inactive *</p> <p>External temperature sensor Via object</p>
Maximum floor temperature	<p>Defines the maximum floor temperature.</p>	<p>24°C - 28 °C * ... 46 °C</p>
Timeout floor temperature object ³	<p>If no temperature value is received during the temperature measurement "via object", then an error message appears in the display after a set time.</p>	<p>0 ... 30 min *... 255 min</p>
Detection of outside temperature	<p>Defines the type of outside temperature detection.</p> <p>Ext. temperature sensor: connected to the device</p> <p>Via object: ext. temperature sensor is connected to an additional device.</p>	<p>Inactive *</p> <p>External temperature sensor Object temperature sensor</p>
Timeout outside temperature object ⁴	<p>If no temperature value is received during the temperature measurement "via object", then an error message appears in the display after a set time.</p>	<p>0 ... 30 min *... 255 min</p>

Application description

KNX thermostat
KNX room controller



Hysteresis - temperature change	Defines the transmission response of the temperature i.e. at what temperature difference the room temperature value should be transmitted to the bus.	0.1°C - 0.5 °C * ... 5.0 °C
Periodical emission of room temperature	Defines the transmission response of the temperature i.e. at what time interval the room temperature value should be transmitted to the bus.	0 *... 255 min
Transmitting room temperature alarm via object	If this parameter is activated (set checkmark (Figure 35 ,1), two additional parameters open for setting the upper/lower temperature threshold values. In the course of this, an alarm message is transmitted to the bus via the objects 44 and 45 if the alarm limits are exceeded or fallen below.	
Minimum room temperature ⁵	If the set value is fallen below, an alarm message is transmitted to the bus.	0°C - 7 °C * ... 40 °C
Maximum room temperature ⁵	If the set value is exceeded, an alarm message is transmitted to the bus.	0°C - 35 °C * ... 40 °C

Table 22: Temperature measurement settings

¹ This parameter is only visible if under "Room temperature detection" the value "External sensor + Objekt or internal temperature sensor and room temperature object" is selected.

² These parameters are only visible if under "Room temperature detection" the value "External temperature sensor + Objekt or Via object and via internal temperature sensor and room temperature object" is selected.

³ This parameter is only visible if under "Floor temperature detection" the value "Via object" is selected.

⁴ This parameter is only visible if under "Detection of outside temperature" the value "Via object" is selected.

⁵ This parameter is only visible if under "Room temperature alarm" the checkmark for transmit via object is activated.

* Default value

Application description

KNX thermostat

KNX room controller



The device has an integrated temperature sensor. Alternatively (e.g. if the installation location of the device is unfavourable or under difficult operating conditions such as in humid areas) or additionally (e.g. in large rooms or halls) a second externally attached temperature sensor can be used to determine the actual value.

When selecting the installation site of the device or external sensor, the following points should be taken into consideration:

- Integrating the device into multiple combinations should be avoided especially when a flush-mounted dimmer is also installed.
- The sensors should not be installed near to large electrical consumers (heat radiation).
- The device/sensor should not be installed near to heaters or cooling systems.
- The temperature sensor must be kept out of direct sunlight.
- Installing sensors on the inside of external walls may negatively influence the temperature measurement.
- Temperature sensors should be installed at least 30 cm away from doors and windows and at least 1.5 m above the floor.

Application description

KNX thermostat
KNX room controller



5.13 Ventilation

The device in its function as a room temperature controller can also control FanCoil actuators. Heating or cooling fans are normally connected to FanCoil actuators. This makes it possible to control the fan driven by heating and cooling systems depending on the control parameters as well as manually via the display.

The actuators mostly implement constant command values of the devices in corresponding switching levels and thus the ventilation level of the connected fans. The greater the command value, the more switching levels activated on the actuator.

FanCoil actuators are able to transmit the current fan speed back to the bus as a response value. The current fan speed is shown in the display.

Devices driven by fans can be, for example, convector fans, so-called FanCoil units
Firstly, under "Room thermostat → General → Fan available" the checkmark must be set (Figure 23 , 1).

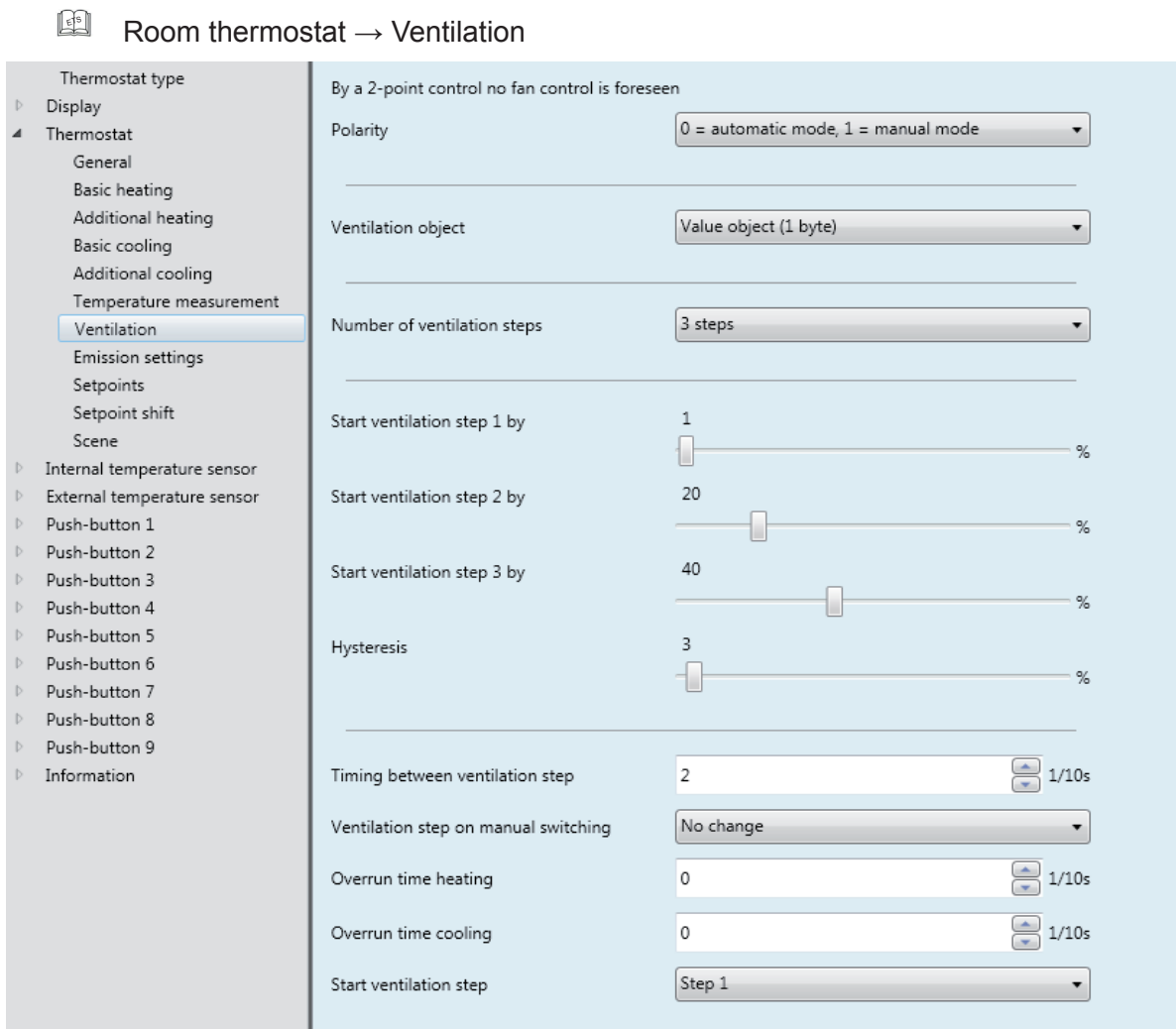

Figure 36: Fan Coil/ventilation function

Application description

KNX thermostat
KNX room controller



Parameters	Description	Value
Polarity	This parameter sets which 1-bit signals switch on the automatic/manual operation.	0 = Automatic mode, 1 = Manual mode * 1 = Automatic mode, 0 = Manual mode
Ventilation object	Defines what type of object controls the fan speeds or displays the status. A 1-bit object for each fan speed or a 1-byte object for all speeds together are available for selection.	Value object 1-byte * Switching object 1-bit
Number of fan speeds ¹	This parameter sets the number of fans speeds (max. 6).	Inactive Speed 1 Speed 2 Speed 3 * Speed 4 Speed 5 Speed 6
Start of the fan speed X (X = 1 ... 6)	In these parameters, the individual value is set for each fan speed using the slidebar.	0 ... 100 %
Hysteresis	This parameter sets a difference value for all fan speeds (example: fan speed = 40%; hysteresis = 10%; fan speed has an upper threshold value at 44% and a lower threshold value at 36%). If the threshold value (e.g. 44%) is exceeded, the next higher fan speed is switched on.	0 ... 3 * ... 100 %
Time between fan speeds	Defines the time a which the fan switches to the next speed	0 ... 2 * ... 255 ^{1/10s}
Fan speed in manual operation	This defines here which fan speed is active when changing over to manual operation.	Off 1 2 3 4 5 6 No change *
Delay time, heating	This parameter sets the ventilation time in "Heating" operation, i.e how long the fan is switched on in manual operation.	0 ... 2 * ... 255 ^{1/10s}
Delay time, cooling	This parameter sets the ventilation time in "Cooling" operation, i.e how long the fan is switched on in manual operation.	0 ... 2 * ... 255 ^{1/10s}
Start fan speed	This parameter defines start fan speed at which the fan should start.	Off 1 * 2 3 4 5 6



Table 23: Function "FanCoil"

¹ Depending on the number of fan speeds selected, a separate setting parameter opens for each individual fan speed (slidebar).

* Default value

Application description

KNX thermostat
KNX room controller

In the display two different symbols for heating  or cooling  can be displayed. The fan speed is displayed in the centre of the fan symbol as a number. If a FanCoil actuator is switched off (no fan speed active), a zero is displayed in the centre of the fan symbol.

The device can be switched and reported back according to the status in two ways. Either the FanCoil actuator returns the feedback for up to six different 1-bit communication objects, or the actuator uses a 1-byte object as a combined feedback for all fan speeds.

At the same time, the "fan object" parameter defines the data type.

Setting "Switching object (1-bit)":

A separate 1-bit object is available for each fan speed. As soon as a fan speed is activated (object value "1"), the corresponding fan speed appears in the display as a number. In the course of this, the greatest fan speed is always displayed.















Objekt "Fan speed 1 ... 6"						active speed	Symbol (Heating/cooling)
1	2	3	4	5	6		
Object no. 55	Object no. 56	Object no. 57	Object no. 58	Object no. 59	Object no. 60		
0	0	0	0	0	0	Off	 
1	0	0	0	0	0	1	 
1	1	0	0	0	0	2	 
1	1	1		0	0	3	 
1	1	1	1	0	0	4	 
1	1	1	1	1	0	5	 
1	1	1	1	1	1	6	 

Table 24: Fan speed "Switching object 1-bit"

Application description

KNX thermostat
KNX room controller

Setting "1 byte":

The fan speeds are controlled by a common 1-byte object. The received value decides which level appears in the device display.













Objekt "Fan speed"	active speed	Symbol (Heating/cooling)
1 ... 6 Object no. 54		
00	Off	 
01	1	 
02	2	 
03	3	 
04	4	 
05	5	 
06	6	 

Table 25: Fan speed "Value object" (1 byte)

- i** Owing to the inertia of a fan motor, the fan speeds cannot be switched over within arbitrary intervals. The fan speed cannot vary arbitrarily.
- i** The change-over times of the convector fans can be found in the technical data sheets.

Fan speed page

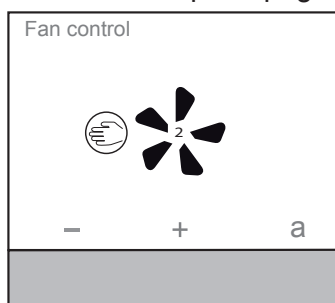

- On the fan speed page, increase/decrease the fan speed with + / -.
The number in the extractor fan symbol indicates the set stage.
- Press touch control surface **a**.
The fan function switches to automatic operation.
The  symbol provides the option of returning back to manual operation.

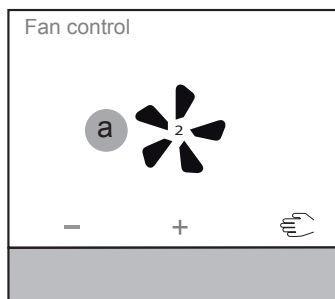



Figure 37: Ventilation/FanCoil/function

Application description

KNX thermostat
KNX room controller

5.14 Transmission settings

In this section, the transmission behaviour is set if value changes.

 Room thermostat → Transmission settings

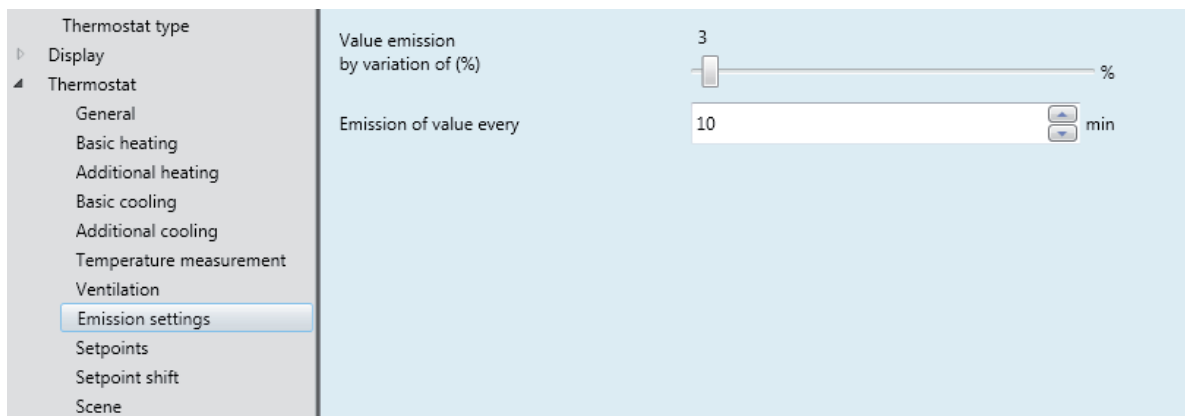

Figure 38: Transmission behaviour if value changes

Parameters	Description	Value
Hysteresis - Output value	The hysteresis value from when an output value change should be transmitted is set with this parameter.	0 ... 3 * ... 100 %
Transmission delay time of the output value	The cycle time for value transmission is set with this parameter.	0 ... 10 * ... 255 min





Table 26: Transmission settings

* Default value

Application description

KNX thermostat
KNX room controller

5.15 Setpoints

The temperature setpoints for heating and/or cooling are set in this section. Temperature setpoints can be assigned for each mode selection in heating and/or cooling operation. It is possible to set setpoints for the mode selections "Comfort , Standby , Night reduction , frost/heat protection  / .

 Room thermostats → Setpoints

 We recommend using the default settings in the ETS.

Thermostat type

- Display
- Thermostat
 - General
 - Basic heating
 - Additional heating
 - Basic cooling
 - Additional cooling
 - Temperature measurement
 - Ventilation
 - Emission settings
 - Setpoints**
 - Setpoint shift
 - Scene
- Internal temperature sensor
- External temperature sensor
- Push-button 1
- Push-button 2
- Push-button 3
- Push-button 4
- Push-button 5
- Push-button 6
- Push-button 7
- Push-button 8
- Push-button 9
- Information

Setpoints heating

- Comfort setpoint heating: +21,0°C
- Standby setpoint heating: +19,0°C
- Night setpoint heating: +16,0°C
- Frost protection setpoint heating: +7,0°C

Setpoints cooling

- Comfort setpoint cooling: +22,0°C
- Standby setpoint cooling: +23,0°C
- Night setpoint cooling: +27,0°C
- Heat protection setpoint cooling: +35,0°C

Setpoint objects: Simple

Difference between basic and additional stages: 2,0K

Emission of setpoint every: 0 min

Fahrenheit: 0 10 20 30 40 50 60 70 80 90 100 110 120 130 140

Celsius: -20 -10 0 10 20 30 40 50 60

Celsius = (Fahrenheit - 32) * $\frac{5}{9}$

Figure 39: Setpoint Settings

The setpoints for the additional stages are derived by a parameterisable interval "difference between basic heating/cooling" of the basic stage.

If required, the setpoints can be adjusted later during ongoing operation on the display of the device by a local operation or object controlled.

Application description

KNX thermostat
KNX room controller



Parameters	Description	Value
Setpoint comfort (Heating) ¹	The setpoint for comfort operation is set with this parameter.	7 ... 21 * ... 40 °C
Setpoint standby (Heating) ¹	The setpoint for standby operation is set with this parameter	7 ... 19 * ... 40 °C
Setpoint night reduction (Heating) ¹	The setpoint for night reduction is set with this parameter	7 ... 16 * ... 40 °C
Setpoint frost/heat protection (Heating) ¹	The setpoint for frost protection is set with this parameter	7 * ... 40 °C
Setpoint comfort (Cooling) ²	The setpoint for comfort operation is set with this parameter	7 ... 22 * ... 40 °C
Setpoint standby (Cooling) ²	The setpoint for standby operation is set with this parameter	7 ... 23 * ... 40 °C
Setpoint night reduction (Cooling) ²	The setpoint for night reduction is set with this parameter	7 ... 27 * ... 40 °C
Setpoint frost/heat protection (Cooling) ²	The setpoint for heat protection is set with this parameter	7 ... 35 * ... 40 °C
Objects for setpoint	<p>Defines the objects for changing the setpoints (Heating/Cooling).</p> <p>Single: Here, "2-byte objects" are available for each mode selection.</p> <p>Combined: Here, one "8-byte object" is available for all mode selections.</p> <p>Both: Here, 8-byte - and 2-byte objects are available.</p>	<p>Single *</p> <p>Combined</p> <p>Both</p>
Difference between basic heating and additional heating/cooling ³	Here, the temperature interval between the setpoints of the basic stage to the additional stages is set for heating/cooling.	1 ... 2 * ... 10 °C
Transmission delay time of the setpoint	Time until transmission of the setpoint	0 * ... 255 min

Table 27: Setpoint Settings

¹ The setpoints of heating can only be changed if a function is selected with "Heating participation" under parameter "Room thermostat → General → Mode selection".

² The setpoints of cooling can only be changed if a function is selected with "Cooling participation" under parameter "Room thermostat → General → Mode selection".

³ This parameter is only visible if a function is selected with "Basic/additional heating" under parameter "Room thermostat → General → Mode selection".

* Default value

Application description

KNX thermostat
KNX room controller

5.16 Basic display

Under "Room thermostat → Basic display" the values for the temperature adjustment are to be set on the display for the page "Basic display". Here, the increment level must first be set, i.e. by how many °C the temperature should change per push-push-button action. Furthermore, the minimum and maximum setpoint must be defined. When doing so, the upper or lower adjustable threshold value is defined for each mode selection.

 Room thermostat → Basic display

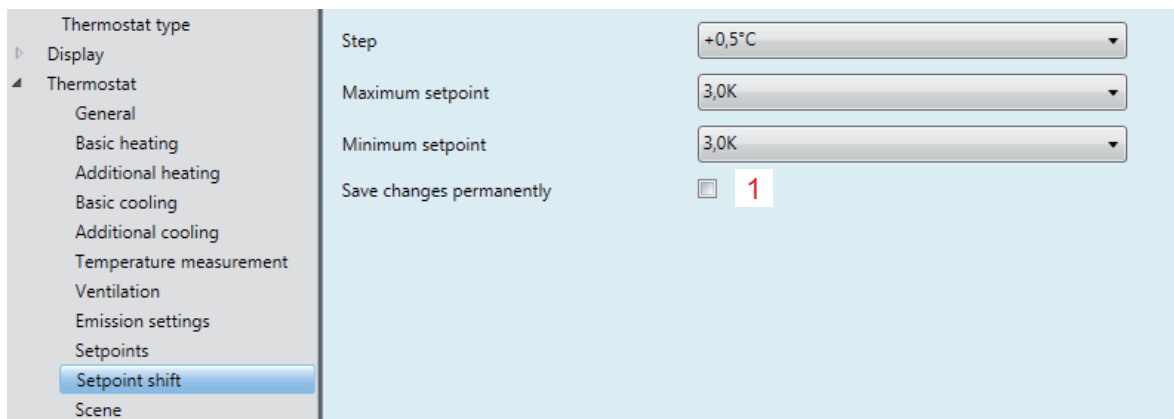

Figure 40: Room thermostat "Basic display"

Parameters	Description	Value
Stage	Defines the increment for each push-push-button action. The temperature is increased/ decreased by the set value with each push-push-button action.	+ 0.1 °C + 0.5 °C * + 1.0 °C
Maximum setpoint	Defines the upper threshold value of the set temperature on the display.	+ 1.0 °C ... + 3.0 °C * ... + 10.0 °C
Minimum setpoint	Defines the lower threshold value of the set temperature on the display.	+ 1.0 °C ... + 3.0 °C * ... + 10.0 °C
Apply change permanently	This function is deactivated as the default situation (Figure 40 ,1). If this function is activated, manual changes of the setpoint are then applied permanently on the display. If the function is deactivated, the adjustment of the setpoint is only applied for the duration of the mode selection active during this time.	

Table 28: Room thermostat "Basic display"

* Default value

Application description

KNX thermostat
KNX room controller

5.17 Scene settings

In this section, the basic settings for the scene control must be made. It is possible to depict up to 64 scenes and to assign the mode selection function Auto, Comfort, Standby, Night lowering, Frost protection to the corresponding scenes.

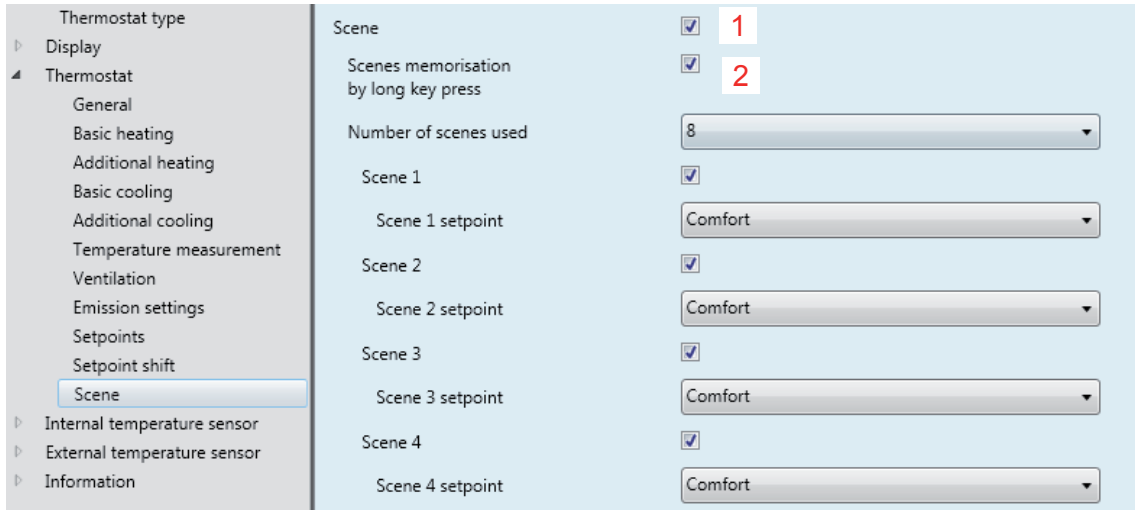

Figure 41: Scene settings

Parameters	Description	Value
Scene	This parameter is active by default (checkmark is set, Figure 41 ,1). The parameter settings can be displayed or hidden with this.	
Store scene by long key-press	This parameter is active by default (checkmark is set, Figure 41 ,2). A changed scene can be saved by a long press of the touch control surface.	
Number of scenes used	Defines how many scenes are needed. A maximum of 64 scenes can be created.	8 * ...16...32...48...64
Scene x	If the checkmark is enabled on the corresponding scene x, these scenes can be parameterised.	
Control setpoint for scene x: ¹	With this parameter, the corresponding mode selection is assigned to the selected scene.	Auto Comfort * Standby Night Reduction Frost Protection.

Table 29: Scene settings

¹ This parameter is only visible if the corresponding scene is activated.

“Scene” communication objects

No.	Name	Object function	Length	Data type
24	Room thermostats	Scene	1 byte	18.001 DPT_Scene control

* Default value

Application description

KNX thermostat
KNX room controller

6. Temperature sensor settings

In this section, the settings for the internal temperature sensor as well as for an external temperature sensor to be connected additionally have to be made. The "temperature calibration" value, transmission response at a temperature value change of ... °C" and the "transmission response in time" has to be set for both temperature sensors.

6.1 Internal temperature sensor

In the "Internal temperature sensor" menu, the values for the temperature calibration are set. Here, a temperature reference measuring device should be for used the current room temperature control. This measured temperature value is compared with the measured temperature in the device and changed if necessary.



Internal temperature sensor → Internal temperature sensor

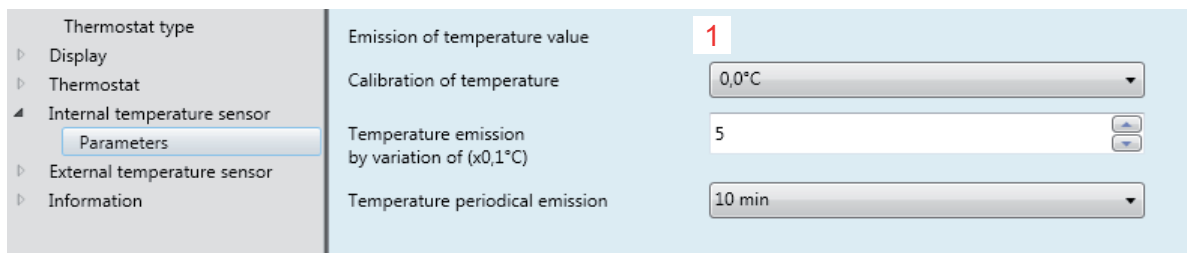

Figure 42: Internal temperature sensor settings

Parameters	Description	Value
Temperature value transmission	Checkmark is disabled by default (Figure 42,1). If this parameter is activated, the "communication object 89 - internal temperature sensor" is visible.	
Temperature calibration	Here, the difference between the temperature value on the device and the measured value e.g. of an external measuring device, is set.	-5°C - 0 °C * ... +5 °C
Temperature transmission by difference of (x 0.1°C)	Here, you set at what temperature difference the new measured temperature value should be transmitted to the bus.	0 ... 5 * ... 255
Temperature periodical transmission	The parameter determines the cycle time interval in which the newly measured temperature value is transmitted to the bus.	Inactive 10 s .. 10 min *

Table 30: Internal temperature sensor settings

No.	Name	Object function	Length	Data type
41	Room thermostats	Room temperature (Heating)	2 byte	9.001 DPT_Temperature (°C)
43	Room thermostats	Room temperature (Cooling)	2 byte	9.001 DPT_Temperature (°C)
89	Temperature	Internal temperature sensor	2 byte	9.001 DPT_Temperature (°C)

* Default value

Application description

KNX thermostat
KNX room controller

Temperature adjustment of the internal sensor on the device

□ Page Settings → Internal sensor

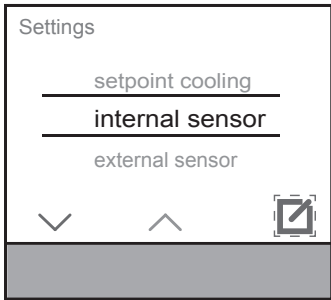

On the Settings page, select the "Internal temperature sensor" parameter using the arrow buttons \wedge / \vee and confirm with .

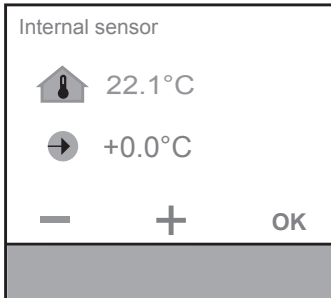

In the "Internal temperature sensor" parameter, set the temperature adjustment using the + / - buttons and then confirm with **OK**.

Figure 43: Internal temperature sensor, temperature adjustment

Application description

KNX thermostat
KNX room controller

6.2 External temperature sensor

In the "External temperature sensor" menu, the values for the temperature calibration are set. Here, a temperature reference measuring device can be used for the current room temperature control. This measured temperature value is compared with the measured temperature on the sensor and changed if necessary.



External temperature sensor → External temperature sensor

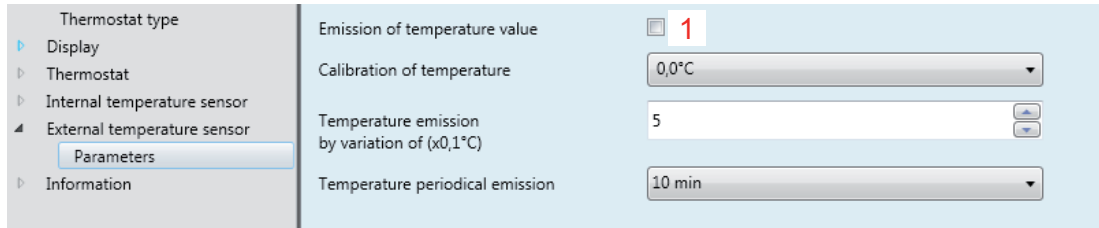

Figure 44: External temperature sensor settings

Parameters	Description	Value
Temperature value transmission	Checkmark is disabled by default (Figure 44,1). If this parameter is activated, the "communication object 90 - external temperature sensor" is visible.	
Temperature calibration	Here, the difference between the temperature value on the sensor and the measured value e.g. of an external measuring device, is set.	-5°C - 0 °C * ... +5 °C
Temperature transmission by difference of (x 0.1°C)	Here, you set at what temperature difference the new measured temperature value should be transmitted to the bus.	0 ... 5 * ... 255
Temperature periodical transmission	The parameter determines the cycle time interval in which the newly measured temperature value is transmitted to the bus.	Inactive 10 s .. 10 min *

Table 31: External temperature sensor settings

No.	Name	Object function	Length	Data type
41	Room thermostats	Room temperature (Heating)	2 byte	9.001 DPT_Temperature (°C)
43	Room thermostats	Room temperature (Cooling)	2 byte	9.001 DPT_Temperature (°C)
90	Temperature	External temperature sensor	2 byte	9.001 DPT_Temperature (°C)

* Default value

Application description

KNX thermostat
KNX room controller

Temperature adjustment of the external sensor on the device

Page settings → External temperature sensor

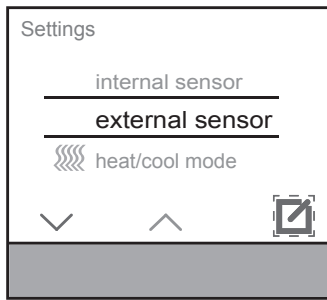

On the Settings page, select the "External temperature sensor" parameter using the arrow buttons \wedge / \vee and confirm with .

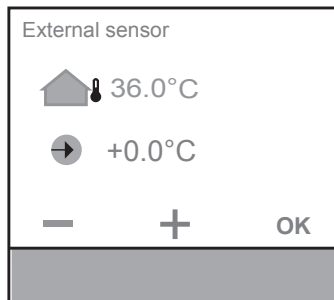

In the "External temperature sensor" parameter, set the temperature adjustment using the + / - buttons and then confirm with **OK**.

Figure 45: External temperature sensor, temperature adjustment

Application description

KNX thermostat
KNX room controller



7. Push-push-button functions

In this section, the settings of the push-button functions are to be made. Up to 3 touch control surfaces with the functions Toggle switch, Switch, Dim, Roller shutter/Blind, Timer, Value 1byte/2byte, Priority, Scenes and Automatic functions can be assigned on a maximum of 9 display pages.

- These functions are only integrated in the "room controller" device.
- The description of the touch function in the following sections is always carried out for "push-push-button 1". The settings must be made accordingly for push-button 2 - 9.

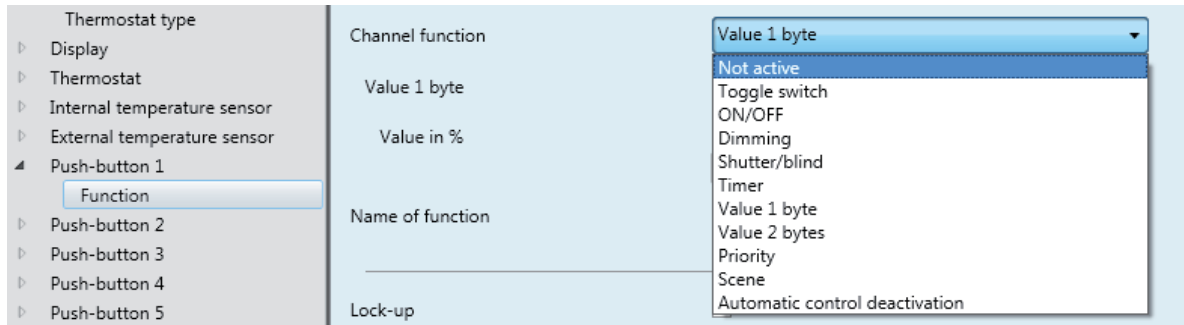

Figure 46: Settings of push-push-button functions

Parameters	Description	Value
Push-button x	With this option you assign the required function to the selected push-button.	Not active * Toggle switch ON/OFF Dimming Shutter/blind Timer 1 Value 1 byte Value 2 bytes Priority Scene Automatic control deactivation

Table 32: Settings of push-push-button functions

¹ A maximum of 9 push-push-button functions can be parameterised

If one of the listed functions is selected, several selection parameters open depending on the function.

7.1 Display mode "Multiple functions" / "Rocker function"

The functions of the "push-button x" can be displayed in two different modes on the display and configured in the ETS. In section 8.1.1 and section 8.1.2 the different configuration types are described.

The display mode is set in the menu item "Channel function → Operating concept".

Channel function → Operating concept

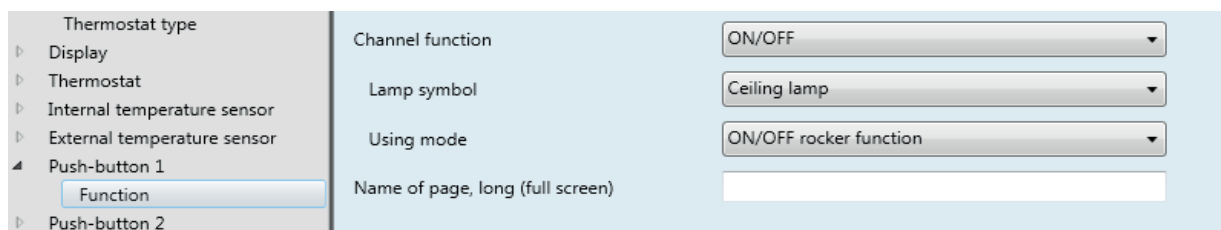

Figure 47: Push-button "Operating concept"

* Default value

Application description

KNX thermostat
KNX room controller

7.1.1 Rocker function push-button

A representation as seen in Figure 48 is achieved by selecting the "Rocker function" under Operating concept or Roller shutter function. The "Rocker function" operating concept is only available under the functions "switching, dimming and roller shutter/blind". A dedicated page is generated in the room controller for each push-button configured as rocker. Thus, up to nine display pages can be configured.

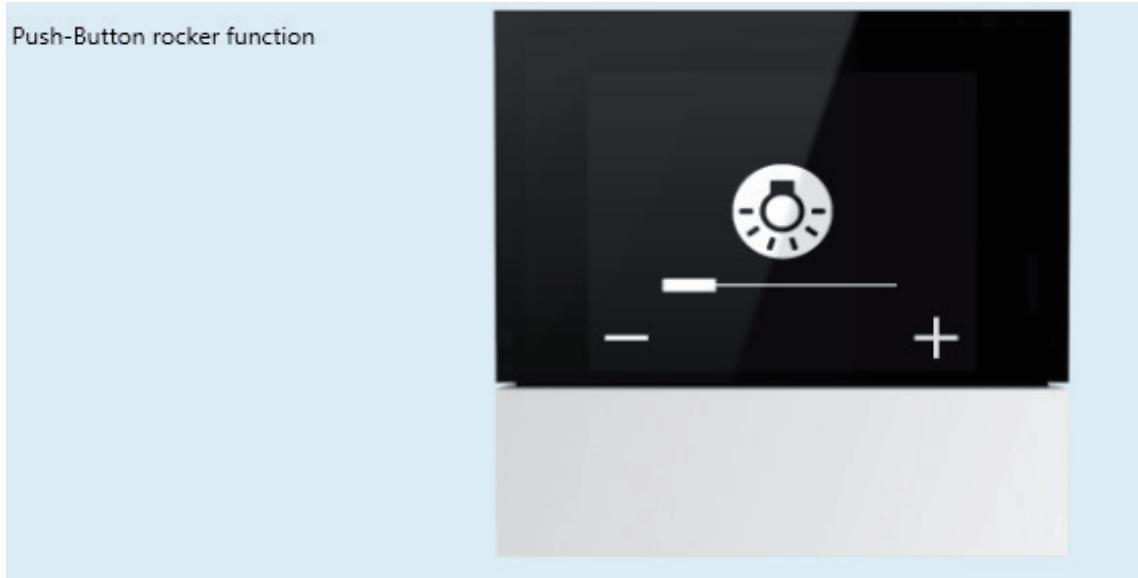

Figure 48: Rocker function push-button

7.1.2 Multiple function push-button

A representation as depicted in Figure 49 is achieved by choosing the option no "rocker function" in the following parameter after selecting the channel function. This variant lists up to a maximum of three push-button functions beginning from the left on the display page. In the case of three consecutive push-push-button functions, the fourth push-push-button function is moved to the next display page. This means that a maximum of three display pages can additionally be configured for a total of 9 push-push-button functions.

If, however, a push-push-button function with the operating concept "rocker function" is selected, this "rocker function" will then be placed onto a separate display page on the next new page.

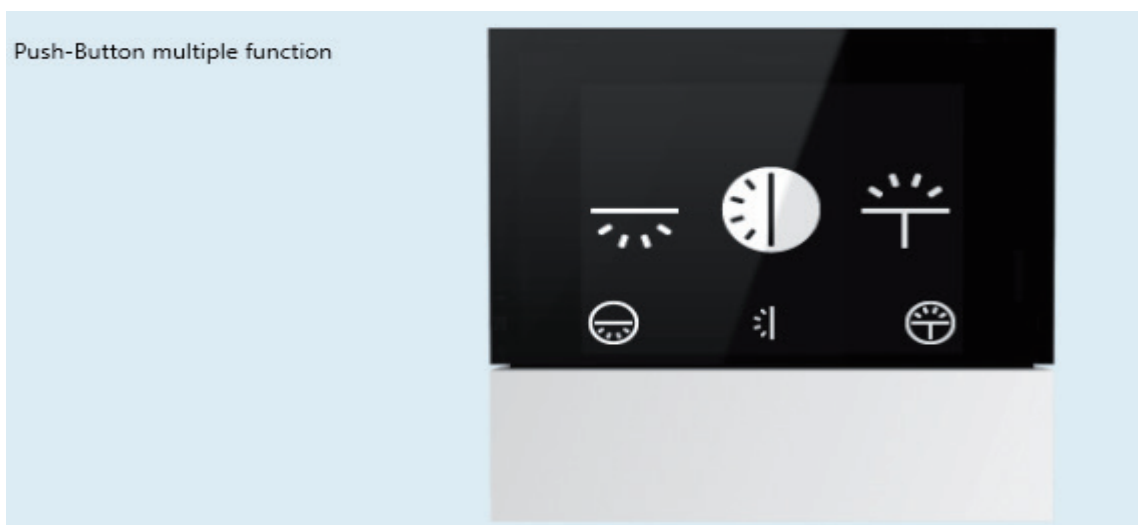

Figure 49: Multiple function push-button

Application description

KNX thermostat
KNX room controller

7.2 Toggle switch function

In the "Toggle switch" function a new state change of the output is generated each time the touch control surface is pressed. The state changes with each new press.

When the corresponding touch control surface is pressed, an On or Off command is transmitted to the bus via the On/Off object depending on the object state. The command transmitted to the bus is the reversal of the last command:

(last command: On -> transmitted command Off; last command: Off -> transmitted command On).

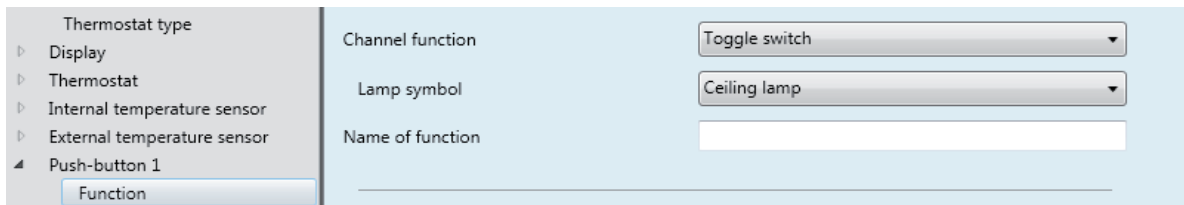

Figure 50: Toggle switch function

Parameters	Description	Value
Lamp symbol ¹	This parameter enables the selection of a suitable symbol for the push-push-button function. This symbol is displayed on one of the self-created display pages.	Switching * Ceiling lamp Floor lamp Wall lamp
Function name	In this parameter, a brief description (text field) can be attached to the selected symbol.	Free text, a maximum of 6 characters allowed

Table 33: Toggle switch function

¹ : An overview of all symbols to be used, including a description, can be found in the Appendix of this document.

No.	Name	Object function	Length	Data type
95.107, 119.131, 143.155, 167.179, 191	Push-button 1 ... 9	ON/OFF status indication	1 bit	1.001 DPT_ON/OFF
100.112, 124.136, 148.16, 172.184, 196	Push-button 1 ... 9	Switching	1 bit	1.001 DPT_ON/OFF

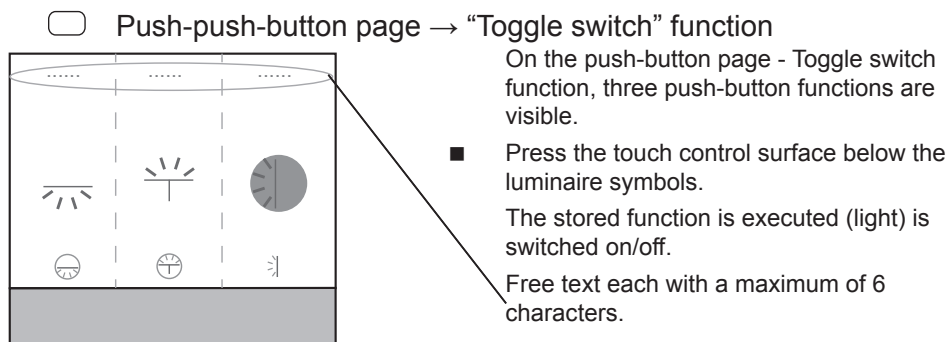

Figure 51: "Toggle switch" function

* Default value

Application description

KNX thermostat
KNX room controller

7.3 Function switching

In the "Switching" function, depending on the parameterisation an On or Off switching command is generated when the respective touch control surface is pressed (no change if pressed again). When the touch control surface is pressed, an ON or OFF command is transmitted to the bus via the On/Off object. The transmitted command is independent of the previous output status. You can set which command is transmitted (ON or OFF) in the parameter "Switching mode selection".

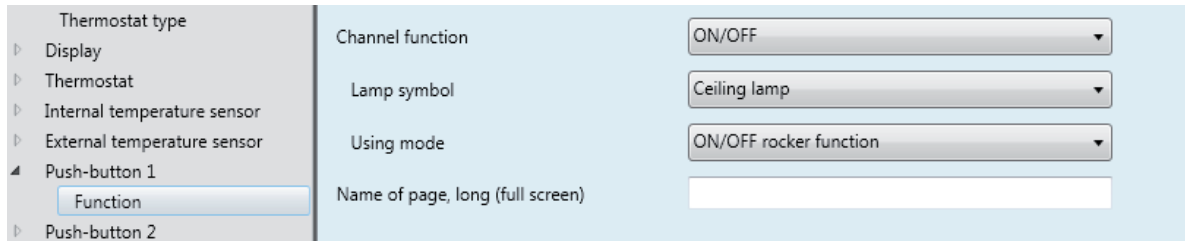

Figure 52: Function switching

Parameters	Description	Value
Lamp symbol	This parameter enables the selection of a suitable symbol for the push-push-button function. This symbol is displayed on one of the self-created display pages.	Switching * Ceiling lamp Floor lamp Wall lamp
Operating concept	The function type during operation is set with this parameter.	ON OFF Switching rocker function *
Page name, long (full screen)	In this parameter, a brief description (text field) can be attached to the selected symbol.	Free text, a maximum of 10 characters allowed
Function name ¹	In this parameter, a brief description (text field) can be attached to the selected symbol.	Free text, a maximum of 6 characters allowed

Table 34: Function switching

¹ This parameter is visible if the value ""On or Off" is selected under operating concept.

 The blocking function can also be activated.

No.	Name	Object function	Length	Data type
95.107, 119.131, 143.155, 167.179, 191	Push-button 1 ... 9	ON/OFF status indication	1 bit	1.001 DPT_ON/OFF
100.112, 124.136, 148.16, 172.184, 196	Push-button 1 ... 9	Switching	1 bit	1.001 DPT_ON/OFF

* Default value

Application description

KNX thermostat
KNX room controller

If in the function switching, "switching rocker" is selected under operating concept, a dedicated page is generated in the room controller.

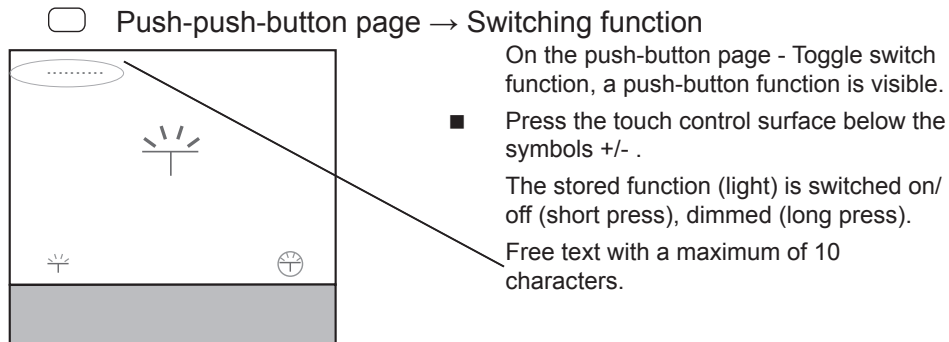

Figure 53: Function switching

Application description

KNX thermostat
KNX room controller



7.4 Function dimming

The "dimming" function is used for dimming/switching light circuits.

If a push-button is pressed for a short time, the device transmits an On or Off command to the bus via the On/Off object, and if a push-button is pressed for a long time, the push-push-button transmits a command via the dimming object for dimming up or down.

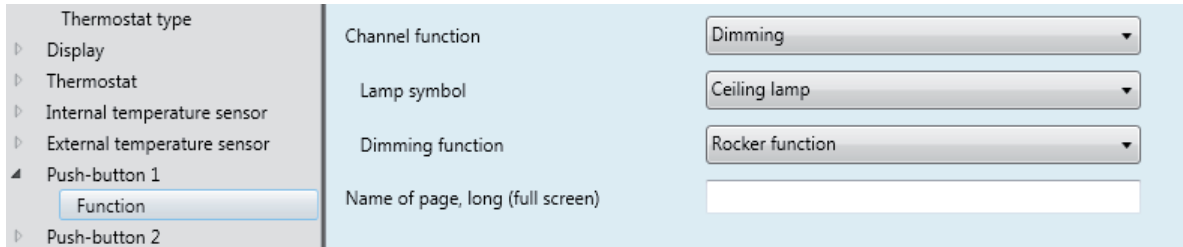

Figure 54: Function dimming

Parameters	Description	Value
Lamp symbol	This parameter enables the selection of a suitable symbol for the push-push-button function. This symbol is displayed on one of the self-created display pages.	Switching * Ceiling lamp Floor lamp Wall lamp
Operating concept	The function type during operation is set with this parameter.	Brighter (ON) * Darker (OFF) Brighter (toggle switch) Darker (toggle switch) 1 dimming push-push-button (brighter/darker, toggle switch) Dimming value Rocker function *
Page name, long (full screen) ¹	In this parameter, a brief description (text field) can be attached to the selected symbol.	Free text, a maximum of 10 characters allowed
Function name ²	In this parameter, a brief description (text field) can be attached to the selected symbol.	Free text, a maximum of 6 characters allowed
Dimming value	This parameter enables a fixed dimming value to be assigned to the lighting and the lamp by means of a fixed dimming value.	0 ... 100 %*

Table 35: Function dimming

¹ This parameter is only visible if "rocker function" is selected for "dimming function".

² This parameter is only visible if "dimming value" is selected for "dimming function".

i The blocking function can also be activated.

* Default value

Application description

KNX thermostat
KNX room controller



No.	Name	Object function	Length	Data type
95,107,119,131, 143,155,167 179,191	Push-button 1 ... 9	ON/OFF status indication	1 bit	1.001 DPT_ON/OFF
100,112,124 136,148,160, 172,184,196	Push-button 1 ... 9	Switching	1 bit	1.001 DPT_ON/OFF
97,109,121, 133,145,157, 169,181,193	Push-button 1 ... 9	Dimming status display	1 byte	5.001 DPT_Percentage (0-100 %)
103,115,127, 139,151,163 175,187,199	Push-button 1 ... 9	Dimming	1 bit	3.007 DPT_Dimmer step
104,116,128, 140,152,164, 176,188,200	Push-button 1 ... 9	Dimming value	1 byte	5.001 DPT_Percentage (0-100 %)

Application description

KNX thermostat
KNX room controller



7.5 Shutter/blind function

The "Blind/shutter" function allows blinds, shutters, awnings or similar hangings to be opened and closed. Thereby, a distinction is made between long and short key-presses.

If a push-button is pressed for a long time, the device transmits an Up or Down command to the bus? via the Up/Down object, the shutter/blind moves to the respective end position or until a stop command is transmitted.

If a push-button is pressed for a short time, the device transmits a stop or a slat adjustment command via the stop object (step) or slat step/stop (step).

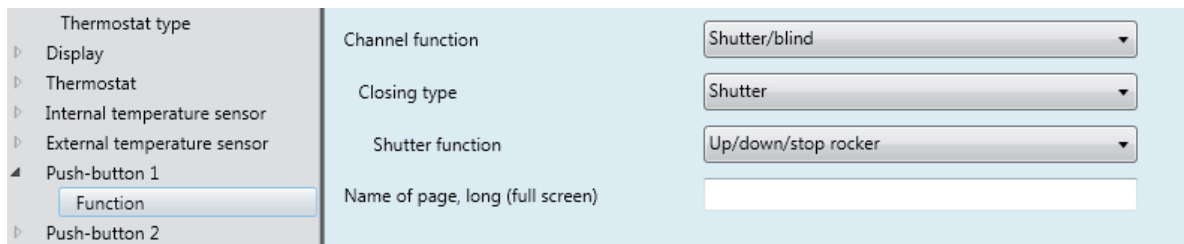

Figure 55: Function shutter

In the blind/roller shutter push-push-button function the choice must first be made between roller shutter or blind in the "mode selection" parameter. The roller shutter function or blind function parameters change depending on the selection.

7.5.1 Shutter function

Shutter		
Parameters	Description	Value
Shutter function	The mode selection is set during operation with this parameter.	Up/Down/Stop push-button Secured Up/Down/Stop push-button Up Down Secured Up(while pressed) Secured down (while pressed) Position (0-100%) Up/Down/Stop rocker * Secured Up/Down/Stop rocker
Function name	In this parameter, a brief description (text field) can be attached to the "Multiple function push-button".	Free text, a maximum of 6 characters allowed
Page name, long (full screen) ¹	In this parameter, a brief description (text field) can be attached to the rocker function push-button.	Free text, a maximum of 10 characters allowed
Position (0-100%) ²	This parameter enables a fixed percentage value and defined position to be assigned to the roller shutter by means of a slider.	0 ... 100 %*

Table 36: Function shutter

¹ This parameter is only visible if the value "Up/Down/Stop rocker or Secured Up/Down/Stop rocker" is selected in the parameter "Shutter function".

² This parameter is only visible if the value "Position (0-100%)" is selected in the parameter "Shutter function".

In the "Shutter" mode selection, the communication objects "top final position reached", bottom final position reached, status indication position in %, Up/Down, Stop (step)" can be selected from.

* Default value

Application description

KNX thermostat
KNX room controller

No.	Name	Object function	Length	Data type
95,107,119,131,143,155,167,179,191	Push-button 1 ... 9	Top final position reached	1 bit	1.002 DPT_Boolesch
96,108,120,132,144,156,168,180,192	Push-button 1 ... 9	Bottom final position reached	1 bit	1.002 DPT_Boolesch
97,109,121,133,145,157,169,181,193	Push-button 1 ... 9	Status indication position in %	1 byte	5.001 DPT_Percentage (0-100 %)
100,112,124,136,148,160,172,184,196	Push-button 1 ... 9	Up/down	1 bit	1.008 DPT_Up/Down
101,113,125,137,149,161,173,185,197	Push-button 1 ... 9	Stop (step)	1 bit	1.017 DPT_Trigger

7.5.2 Function blind

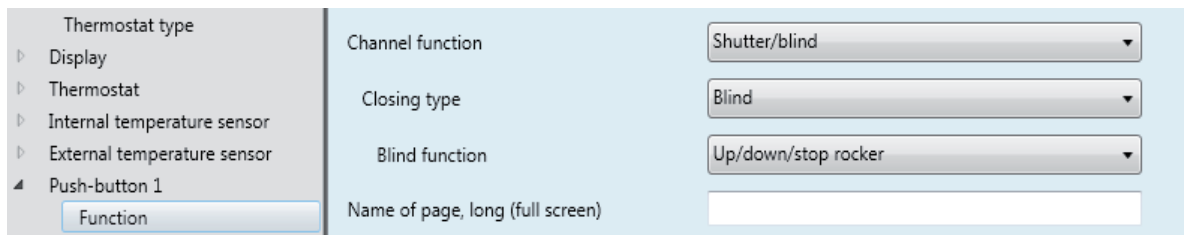

Figure 56: Function blind

Shutter		
Parameters	Description	Value
Function blind	The mode selection is set during operation with this parameter.	Up Down Secured up (while pressed) Secured down (while pressed) Slat angle (0-100%) Position/Slat angle (0-100%) Up/Down/Stop rocker * Secured up/down/Stop rocker
Function name	In this parameter, a brief description (text field) can be attached to the "Multiple function push-button".	Free text, a maximum of 6 characters allowed
Page name, long (full screen) ³	In this parameter, a brief description (text field) can be attached to the rocker function.	Free text, a maximum of 10 characters allowed
Position (0-100 %) ⁴	This parameter enables a fixed percentage value and defined slat position to be assigned to the slat by means of a sidebar.	0 ... 100 % *
Slat angle (0-100%) ^{4 5}	This parameter enables a fixed percentage value and defined position to be assigned to the slat by means of a sidebar.	0 ... 100 % *

Table 37: Function blind

³ This parameter is only visible if the value "Up/Down/Stop rocker or Secured Up/Down/Stop rocker" is selected in the parameter "Blind function".

⁴ These parameters are only visible if the value "Position/Slat angle (0-100%)" is selected in the parameter "Blind function".

⁵ This parameter is only visible if the value "Slat angle (0-100%)" is selected in the parameter "Blind function".

* Default value

Application description

KNX thermostat

KNX room controller



No.	Name	Object function	Length	Data type
95,107,119,131, 143,155,167 179,191	Push-button 1 ... 9	Top final position reached	1 bit	1.002 DPT_Boolesch
96,108,120, 132,144,156 168,180,192	Push-button 1 ... 9	Bottom final position reached	1 bit	1.002 DPT_Boolesch
97,109,121, 133,145,157, 169,181,193	Push-button 1 ... 9	Status indication position in %	1 byte	5.001 DPT_Percentage (0-100 %)
98,110,122, 134,146,158, 170,182,194	Push-button 1 ... 9	Slat position in %	1 byte	5.001 DPT_Percentage (0-100 %)
100,112,124, 136,148,160 172,184,196	Push-button 1 ... 9	Up/down	1 bit	1.008 DPT_Up/Down
101,113,125, 137,149,161, 173,185,197	Push-button 1 ... 9	Slat Step/Stop (step)	1 bit	1.007 DPT_Step

Application description

KNX thermostat
KNX room controller

7.6 "Timer" function

In the "Timer" function, when a short key-press occurs, the parameterised switch output is switched for the time set in the switch actuator. When a long key-press occurs, the ongoing timer operation is interrupted and the switch output is switched off.

When a short key-press occurs, a 1-bit switch command is transmitted to the bus and the respective output is switched on. When a long key-press occurs, an OFF command is transmitted by the same 1-bit object.

- i** This timer function is in the Hager-/Berker system and has been adapted to the Hager TXA switch actuator.

The switch-on time on the output starts running after pressing the push-button the last time. After 10s, an "On command" retriggers the set switch-on time in the parameters. An Off command switches off the output directly.



Figure 57: "Timer" function

Parameters	Description	Value
Function name	In this parameter, a brief description (text field) can be attached to the "Multiple function push-button".	Free text, a maximum of 6 characters allowed

Table 38: Timer

- i** The "timer" function can only be used as a "Multiple function push-button" i.e. a rocker function is not possible here.

If additional ON commands are transmitted to the "Timer" object within 10 s, the switch-on time of the output (for our TXA products) is calculated as follows:

$$\text{Switch-on time} = (1 + \text{number of additional operations}) * \text{set time}$$

The set time begins to count down when the last key-press occurs. Pressing the push-button again after 10 s restarts (retriggers) the time set in the switch actuator. An OFF command switches off the output immediately.

No.	Name	Object function	Length	Data type
95,107,119,131,143,155,167,179,191	Push-button 1 ... 9	ON/OFF status indication	1 bit	1.001 DPT_ON/OFF
100,112,124,136,148,160,172,184,196	Push-button 1 ... 9	Timer	1 bit	1.010 DPT_Start/Stop

Application description

KNX thermostat
KNX room controller

7.7 “Value 1 byte” function

In the following parameter window, the “Value 1 bytes” function is parameterised and set as multiple function push-button in the using mode.

The application provides a 1 bytes communication object for the push-button. Pressing a push-button transmits the set value to the bus.



Figure 58: Function value transmitter 1 byte/2 byte

Parameters	Description	Value
Value 1 bytes	The value type is set during operation with this parameter.	Percent (0-100%) Value (0-255) *
Value (0-255)	A fixed value can be assigned to the function with this parameter.	0 * ... 255
Value in %	This parameter enables a fixed percentage value to be assigned to the function by means of a slider.	0 * ... 100 %
Function name	In this parameter, a brief description (text field) can be attached to the "Multiple function push-button".	Free text, a maximum of 6 characters allowed

Table 39: Value transmitter 1-byte function

- i** The "value 1 byte" function can only be used as a "Multiple function push-button" i.e. a rocker function is not possible here.

No.	Name	Object function	Length	Data type
104,116,128, 140,152,164, 176,188,190	Push-button 1 ... 9	Value (0-255)	1 byte	5.010 DPT_Counting pulse (0-255)
104,116,128, 140,152,164, 176,188,190	Push-button 1 ... 9	Value (0-100)	1 byte	5.010 DPT_Counting pulses (0..100%)

The "Value 1 byte" parameter defines which value range the device should use.

Relative values ranging from 0...100 % can be transmitted to the bus by means of a slide control for the value in % function.

* Default value

Application description

KNX thermostat
KNX room controller

7.8 Value 2 bytes function

In the following parameter window, the "Value 2 bytes" function is parameterised and set as multiple function push-button in the using mode.

The application provides a 2 bytes communication object for the push-button. Pressing a push-button transmits the set value to the bus.

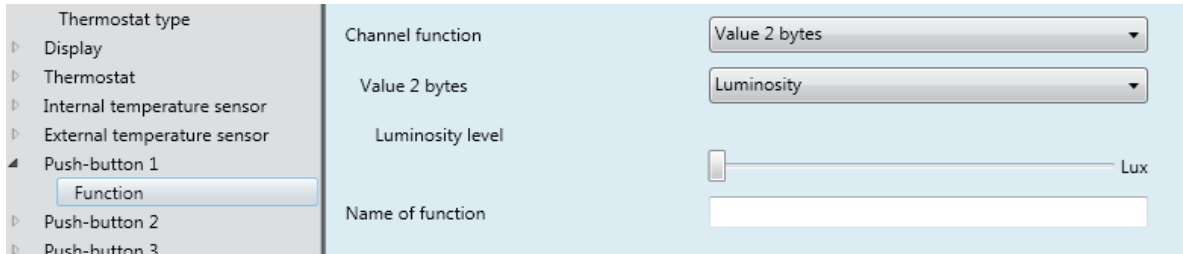

Figure 59: Value 2 bytes function

Parameters	Description	Value
Value 2 bytes	The value type is set during operation with this parameter.	Value (0-255) * Temperature Brightness
Value (0-65535)	A fixed value can be assigned to the function with this parameter.	0 * ... 65535
Temperature	This parameter enables a fixed temperature value to be assigned to the function by means of a sliderbar.	0 * ... 40 °C
Brightness	This parameter enables a fixed brightness value to be assigned to the function by means of a sliderbar.	0 * ... 1000 Lux
Function name	In this parameter, a brief description (text field) can be attached to the "Multiple function push-button".	Free text, a maximum of 6 characters allowed

Table 40: Value 2 bytes function

- i** The "value 2 byte" function can only be used as a "Multiple function push-button" i.e. a rocker function is not possible here.

No.	Name	Object function	Length	Data type
106,118,130, 142,154,166, 178,190,202	Push-button 1 ... 9	Value (0-65535)	2 byte	7.001 DPT_Pulse
106,118,130, 142,154,166, 178,190,202	Push-button 1 ... 9	Brightness value	2 byte	7.001 DPT_Pulse
106,118,130, 142,154,166, 178,190,202	Push-button 1 ... 9	Temperature value	2 byte	7.001 DPT_Pulse

* Default value

Application description

KNX thermostat
KNX room controller

7.9 Priority function

The "Priority" function is configured in this section. This function allows a switch output to be forced to a switch position by a 2-bit telegram regardless of the ON/OFF object (higher priority).

The value of the 2-bit telegram is defined according to the following syntax:

When "Priority" is active, incoming switch telegrams are still evaluated internally and when "Priority" is no longer active, the current internal switch condition is set to the ON/OFF object value accordingly.

A "Priority" function activated before a bus voltage failure is always deactivated after a bus voltage recovery. The effect of the "Priority" function depends on the actuator channel connected (lighting, shutter/blind, heating).

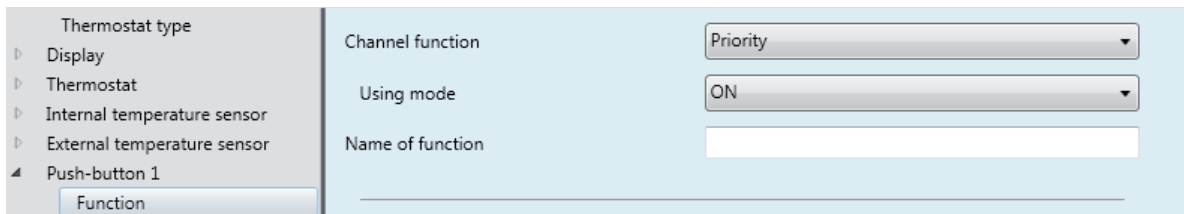

Figure 60: Priority function

Parameters	Description	Value
Operating concept	The function type during operation is set with this parameter.	ON * OFF
Function name	In this parameter, a brief description (text field) can be attached to the "Multiple function push-button".	Free text, a maximum of 6 characters allowed

Table 41: Priority function

- i** The "Priority" function can only be used as a "Multiple function push-button" i.e. a rocker function is not possible here.

Function thermostat

The device can be switched to the frost/heat protection or comfort mode selection by the "Priority" object.

Function room controller

The device can be switched to the frost/heat protection or comfort mode selection by the "Priority" object as well as to the forced position by the push-push-button functions e.g. a switch actuator or second room thermostat.

The following values are transmitted here via the 2-bit object priority

Value		Behaviour of the output
Bit 1	Bit 0	
0	0/1	End of "Priority"
1	0	Priority OFF
1	1	Priority ON

Table 42: Priority behaviour

* Default value

Application description

KNX thermostat

KNX room controller



No.	Name	Object function	Length	Data type
95,107,119,131, 143,155,167 179,191	Push-button 1 ... 9	Priority status indication	1 bit	1.011 DPT_Status
102,114,126 138,150,162, 174,186,198	Push-button 1 ... 9	Mandatory control	2 bit	2.002 DPT_Boolean control)

Example priority

The window cleaner function is an application that prevents a manual operation of the blind/roller shutter from being executed during the window cleaning. As a result, the blind/roller shutter operation is disabled from a central point. Blinds that have already been lowered are moved to the upper stop position. The manual blind/roller shutter function is also enabled from a central point.

Application description

KNX thermostat
KNX room controller



7.10 Scene function

In the following parameter window, the "Scene" function is parameterised and set as or multiple function push-button in the using mode.

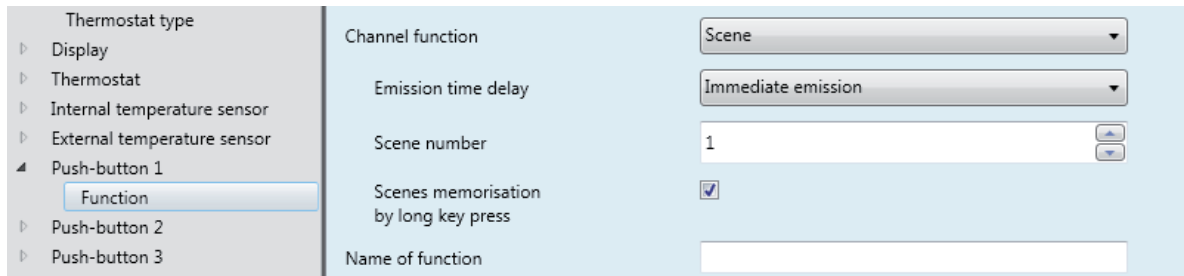

Figure 61: Scene function

The "Scene" function can be used as a scene extension and can be used to call up or save configured light scenes that are stored in other KNX devices. The device can call up and save a maximum of 64 scenes. Through a short key-press, the device transmits a value between 0 and 63 (where value 0 corresponds to scene 1 and value 63 corresponds to scene 64) to the bus via the scene communication object. The scene is called up when the push-button is released. This function allows scenes to be called up and saved. Up to 64 scenes can be called up by the device and saved by a long press of the push-button (set to 5 s by default).

Bit number							
7	6	5	4	3	2	1	0
Save	X	Scene number (0 ... 63; bit number 0 corresponds to = Scene1) ⇒ 2 ⁶ = 64 scenes are to be used					

Table 43: Structure of 1-byte scene object

If the scene memorisation function is activated with a long key-press, the scene parameter values can be connected to the device and stored with a long key-press. Scene memorisation can also be deactivated with a long key-press (remove checkmark).

Parameters	Description	Value
Transmission delay	This parameter sets the delay time when the command is transmitted to the bus after pressing the touch control surface.	Immediate emission * 1 s - 5 min
Scene number	The scene number is set with this parameter.	1 * ... 64
Saving the scene by a long press of the push-button ^N	A changed scene can be saved again by activating this function by ticking the box.	
Function name	In this parameter, a brief description (text field) can be attached to the "Multiple function push-button".	Free text, a maximum of 6 characters allowed

Table 44: Scene function

* Default value

Application description

KNX thermostat
KNX room controller



- i** The "scene" function can only be used as a "Multiple function push-button" i.e. a rocker function is not possible here.

No.	Name	Object function	Length	Data type
104,116,128 140,152,164, 176,190,202	Push-button 1 ... 9	Scene	1 byte	18.001 DPT_Scene control

Application description

KNX thermostat
KNX room controller

7.11 Deactivate automatic function

The "Deactivate automatic functions" function is described and presented in the following section.

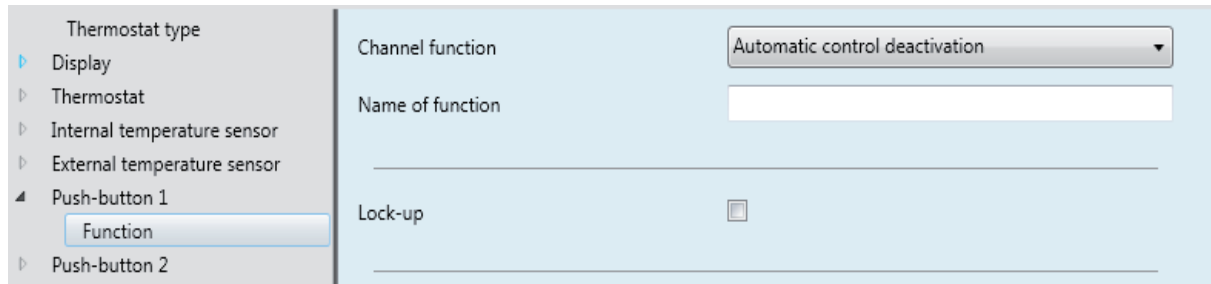

Figure 62: Deactivate automatic function

The automatic control function can control an output in parallel with the switching/toggling/roller shutter/blind function. The functions have the same priority level. The last command received influences the state of the output.

An additional command object is used to activate or deactivate an automatic control.

The "Automatic control" function is tested in the Hager/Berker system and is adapted to the switch actuators of the TXAxxx, TXBxxx and TXMxxx series.

Parameters	Description	Value
Function name	In this parameter, a brief description (text field) can be attached to the "Multiple function push-button".	Free text, a maximum of 6 characters allowed

Table 45: Automatic function

No.	Name	Object function	Length	Data type
95,107,119,131,143,155,167,179,191	Push-button 1 ... 9	Automatic control deactivation status	1 bit	1.003 DPT_Enable
100,112,124,136,148,160,172,184,196	Push-button 1 ... 9	Deactivate automatic	1 bit	1.003 DPT_Enable

- i** The "automatic control deactivation" function can only be used as a "Multiple function push-button" i.e. a rocker function is not possible here.

* Default value

Application description

KNX thermostat
KNX room controller



With this 1-bit communication object automatic sequences already running in the actuators can be deactivated, switched off.

Example: time-dependent outside lighting ON/OFF

The outside lighting is switched on and off at a certain time every day of the week.

However, on certain occasions (garden parties) the outside lighting should stay on for longer. In this case, the "Automatic control deactivation" function is used to deactivate/switch off the time-dependent switching on/off of the outside lighting. To do so, a 1-bit command is transmitted to the bus.

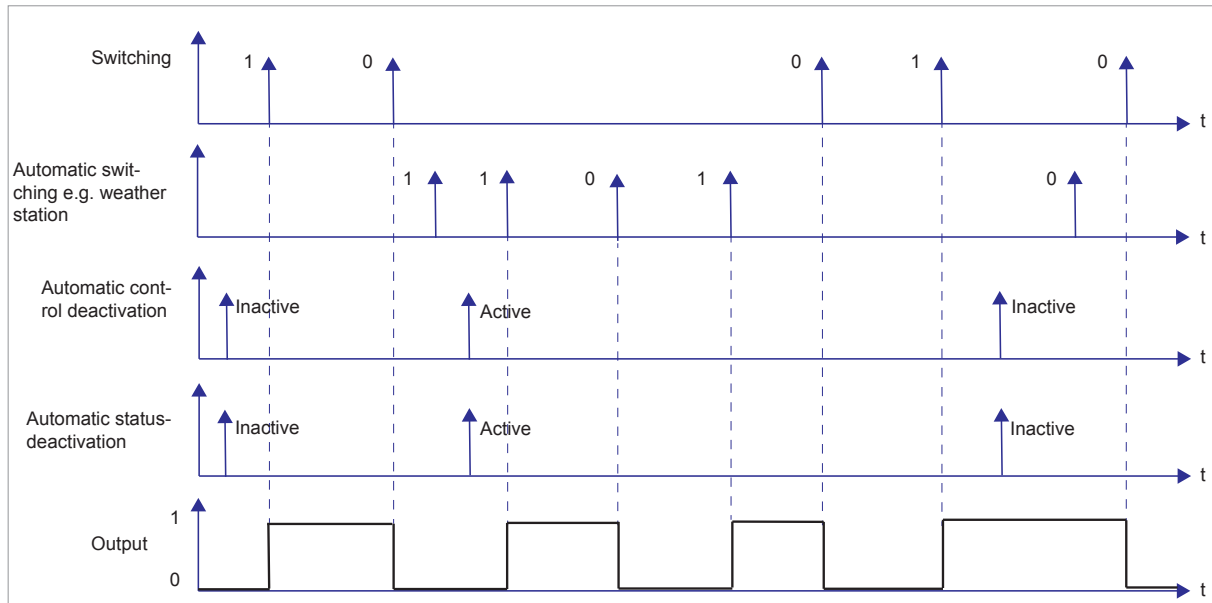

Figure 63: Automatic control function with switching/toggle commands

An additional command object is used to activate or deactivate an automatic control.

Application description

KNX thermostat
KNX room controller

Example of automatic control function with switching/toggle commands:

Actual state:

The outside lighting is switched on and off at fixed times, e.g. by a weather station.

Set state:

If during a garden party, for example, the lighting should remain switched on for a longer time than the time set in the weather station, the "Automatic timer control" in the weather station can be interrupted by the "Automatic control deactivation" function. This "Automatic timer control" in the weather station will be interrupted as long as a 0-signal is present on the "Automatic control deactivation" communication object.

The lighting will remain switched on until the "Automatic control deactivation" function is switched off.

Automatic control function with roller shutter/blind commands

The Automatic control function can control a switch actuator output in parallel with the roller shutter/blind function, while the Up/Down/Position/Slat angle command last received influences the state of the output at the same time (see Figure 64).

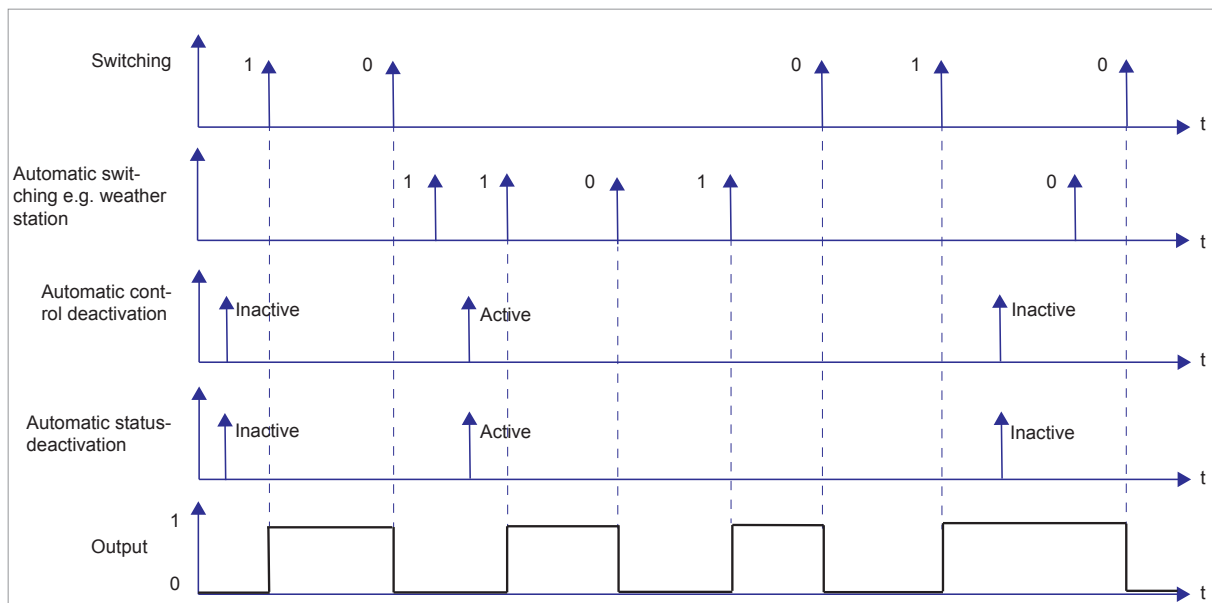

Figure 64: Automatic control function with roller shutter/blind commands

An additional command object is used to activate or deactivate an automatic control.

Example of automatic control function with roller shutter/blind commands

Actual state:

The roller shutters/blinds are opened and closed e.g. by a weather station at fixed times.

Set state:

If during a garden party, for example, the roller shutter/blinds should remain open for a longer time than the time set in the weather station, the "Automatic timer control" in the weather station can be interrupted by the "Automatic control deactivation" function. This "Automatic timer control" in the weather station will be interrupted as long as a 0-signal is present on the "Automatic control deactivation" communication object.

The roller shutter/blinds remain in the top final position until the "Automatic control deactivation" function is switched off.

Application description

KNX thermostat
KNX room controller

7.12 Blocking function

The device has a blocking function (described in section 4.6), that can be used to block individual push-push-button functions. To activate the blocking function for each push-button, the "blocking function" must be explicitly activated (checkmark set) in the "push-button x" parameter branch for each push-button.

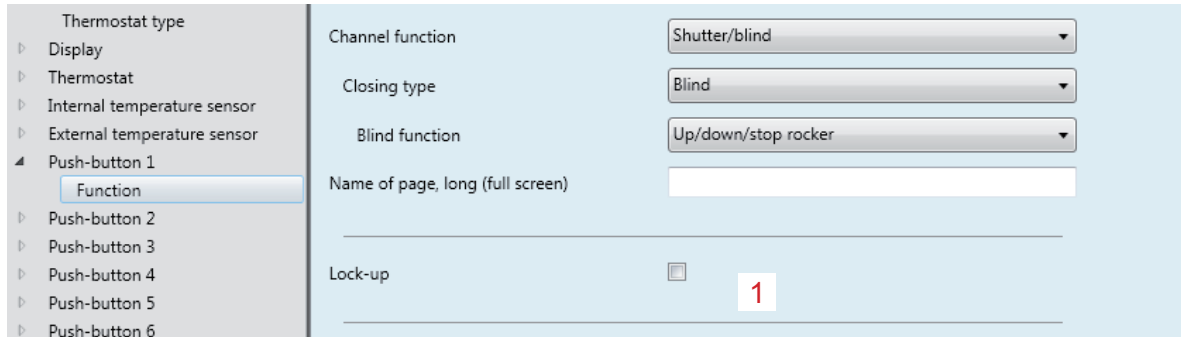

Figure 65: Push-button - Blocking function

After bus voltage recovery, a lock-up remains active if it was activated before the bus voltage failed. The lock-up is always deactivated after a programming process by the ETS.

Application description

KNX thermostat
KNX room controller

8. Further display settings

8.1 Config mode

On the Settings page after selecting the "Config mode" menu item, you can load the physical address via the ETS.

At the factory this is 15.15.255

Menu setting → Config mode

8.2 Reset

In the Reset menu, the device can be reset to the factory settings. Any settings made will be lost. The parameter settings must be set once again and the device must be reprogrammed with the physical address.

Menu setting → Reset

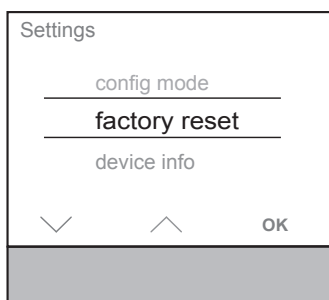

- In the Settings menu, select the "Reset" parameter using the arrow buttons \wedge / \vee and confirm with **OK**.
Menu switches.

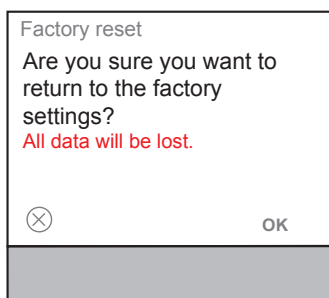

- The reset is performed by pressing the **OK** button > 10 seconds.
- You can exit the page without performing a reset by pressing \otimes .
The view switches back to the Settings menu.

Figure 66: Reset

Application description

KNX thermostat
KNX room controller



8.3 Info

The system information of the device, such as manufacturer, software version, date of last ETS download and the physical address are displayed in the Info menu.

Menu setting → Info

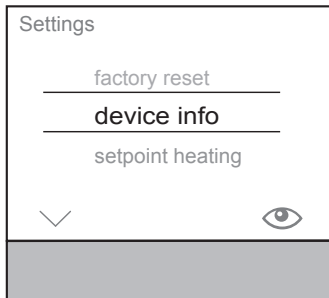

In the Settings menu, select the "Reset" parameter using the arrow buttons ^ / v and confirm with

Menu switches.

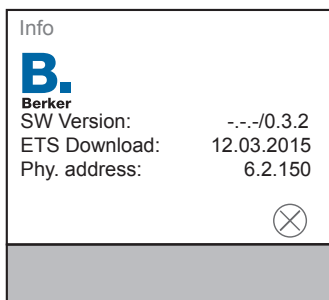

The following details are displayed on the Info menu page:

Manufacturer

Software version

Date last ETS download

Physical address

Exit the menu by pressing the press touch control surface

Figure 67: Info



In the ETS, the relevant device information can be viewed in the Info parameter.

The application version, database version and version of the translation file are displayed in the application software.

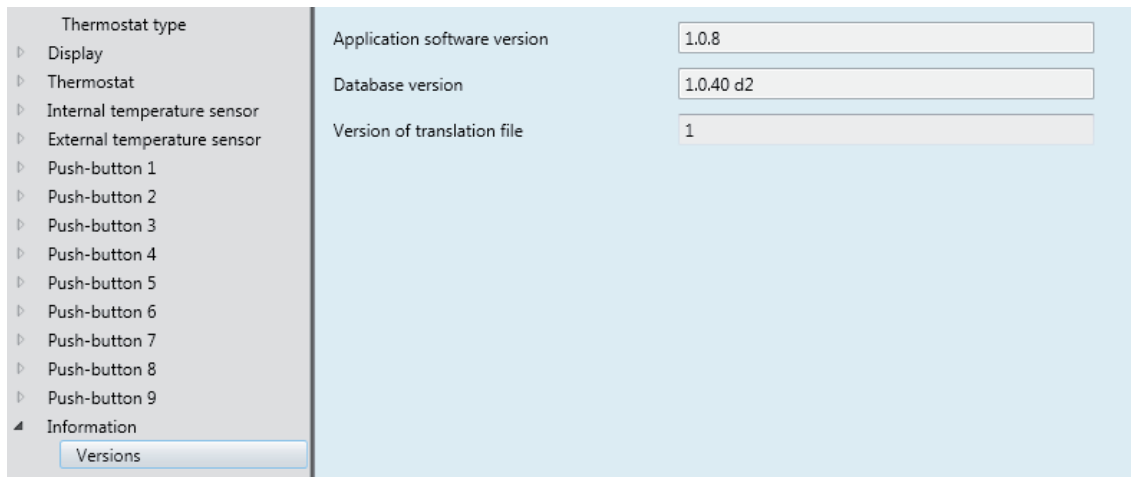

Figure 68: Info

Application description

KNX thermostat
KNX room controller

9. Page Timer

On the Timer page the switching performance of the mode selections comfort, standby and night operation can be set and configured for a weekday or section of the week.

Timer program

When delivered, timer is active.

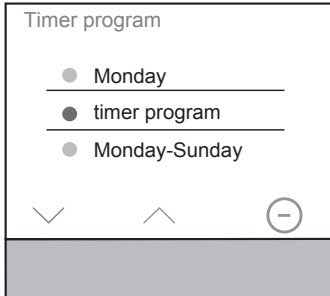

Select the timer parameter with \wedge / \vee .

Switch timer on/off using \ominus / \bullet .

i If the timer program is activated, the set programming block is automatically executed once a week recurrently. If the timer is deactivated, adjustments to the temperature setpoint or mode selection must be set manually.

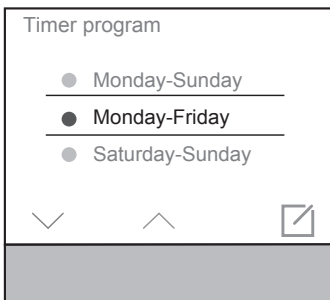

- Select a section of the week or weekday with \wedge / \vee .
- Confirm with

The display changes for setting the switching time.

The night mode selection is selected automatically.

If necessary change with \wedge to select another mode selection.

- Set the switch-on/switch-off time with + / -
- i** The operation should be repeated for additional switching times.
- Swipe your finger over the touch control surface.

The confirmation prompt is displayed. The display returns to the Timer submenu. The coloured circle next to the weekday or section of the week changes colour. Weekdays or sections of the week with the same coloured circles are configured with the switching times.

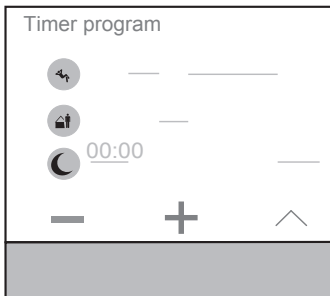

Figure 69: Timer program

The "self-learning heating curve" can be activated/deactivated on the timer in the "Optimisation" parameter. If the function is deactivated, the heating or cooling system will only be active at the set times.

Application description

KNX thermostat
KNX room controller

10. Page No problem

Page No problem → Reset to settings of JJJJ/MM/DD

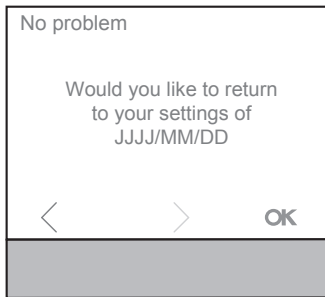

On the No Problem page, it is possible to reset the device to a setting variant that was parameterised previously. Firstly, the created ETS variant and the settings last changed on the display are saved

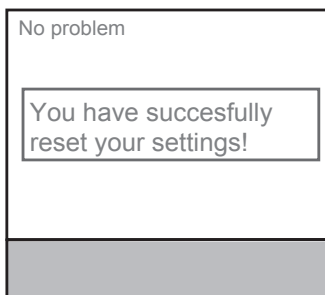
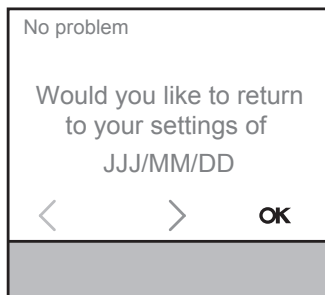

Confirmation after successful reset to the settings of YYYY/MM/DD.

Figure 70: Page No problem, display

Application description

KNX thermostat
KNX room controller



11. ETS software characteristics

Product	Room thermostats	Room controller
Max. number of group addresses	254	254
Max. number of assignments	255	254
Objects	90	198

Table 46: ETS software characteristics

12. Technical data

KNX medium	TP 1
Configuration mode	S-Mode, E-Controller
Rated voltage KNX	24 V _~ +/- 6 % SELV
Auxiliary voltage	24 V _~ +/- 6 % SELV
Current consumption KNX	max. 10 mA
Current consumption 24 V auxiliary voltage	25 mA
Connection mode KNX	KNX connecting terminal
Power reserve battery	≈ 4 h
Operating altitude	< 2000 m
Operating temperature	-5 ... +45 °C
Storage/transport temperature	-25 ... +70 °C
Humidity	max. 60% < 45 °C, 90% at 45 °C, no condensation
Screen diagonal	1.93''
Screen size	38.28 x 30.26 mm
Cable length ext. temperature sensor	max. 10 m
Degree of protection	IP21C
Impact protection	IK 04
Protection class	III
Test mark	KNX, CE
Electric strength	4 KV
Overvoltage category	III
Degree of contamination	2
Control function	class A
Mode of action	type 2
Ball pressure test	at 75 °C
Standards	EN 60730-2-9, EN 50491-3 EN 50491-5-2

13. Accessories

Cover for KNX thermostat with display S.x / B.x	8096 01 8x
Cover for KNX thermostat with display K.x	8096 01 7x
Cover for KNX thermostat with display Q.x	8096 01 2x
Temperature sensor	EK090, EK089, EK088
KNX power supply 320 mA + 24 V _~ , 640 mA	TXA114
Power supply 24 V _~	TGA200

Application description

KNX thermostat
KNX room controller



14. Warranty

We reserve the right to realise technical and formal changes to the product in the interest of technical progress.

Our products are under guarantee within the scope of the statutory provisions.

If you have a warranty claim, please contact the point of sale.

Application description

KNX thermostat
KNX room controller

Table of Figures

Figure 1: Device overview	6
Figure 2: Display elements	7
Figure 3: Operating concept "Push-push-button operation"	8
Figure 4: Operating concept "Slider operation"	8
Figure 5: Selection device variant	13
Figure 6: Basic display	14
Figure 7: General settings	15
Figure 8: Screen brightness	16
Figure 9: Screensaver	17
Figure 10: Choice of language	18
Figure 11: User messages	19
Figure 12: Time	20
Figure 13: Date/time	21
Figure 14: 24 ^h /12 ^h Time format	21
Figure 15: Basic display	22
Figure 16: Basic display	23
Figure 17: State of the house	24
Figure 18: Overview "Configuration status message"	26
Figure 19: Page Status messages	27
Figure 20: Blocking function	28
Figure 21: Time setting for long push-push-button action	29
Figure 22: Overview heating/cooling variants	30
Figure 23: Settings "General - room thermostat"	31
Figure 24: Mode selection	36
Figure 25: Overview diagram "Mode selection change-over via object with presence object" (4x1 bit)	37
Figure 26: Overview diagram "Mode selection change-over via object with presence detector" (4x1bit)	38
Figure 27: Holiday mode	43
Figure 28: Room thermostat - Basic heating	45
Figure 29: Room thermostat - Additional heating	47
Figure 30: Setpoint heating, mode selection night	48
Figure 31: Room thermostat - Basic cooling	49
Figure 32: Room thermostat - Additional cooling	51
Figure 33: Setpoint cooling, mode selection Night	52
Figure 34: Heating or cooling mode	53
Figure 35: Temperature measurement settings	54
Figure 36: Fan Coil/ventilation function	58
Figure 37: Ventilation/FanCoil/function	61
Figure 38: Transmission behaviour if value changes	62
Figure 39: Setpoint Settings	63
Figure 40: Room thermostat "Basic display"	65
Figure 41: Scene settings	66
Figure 42: Internal temperature sensor settings	67

Application description

KNX thermostat
KNX room controller

Figure 43: Internal temperature sensor, temperature adjustment	68
Figure 44: External temperature sensor settings	69
Figure 45: External temperature sensor, temperature adjustment	70
Figure 46: Settings of push-push-button functions	71
Figure 47: Push-button "Operating concept"	71
Figure 48: Rocker function push-button	72
Figure 49: Multiple function push-button	72
Figure 50: Toggle switch function	73
Figure 51: "Toggle switch" function	73
Figure 52: Function switching	74
Figure 53: Function switching	75
Figure 54: Function dimming	76
Figure 55: Function shutter	78
Figure 56: Function blind	79
Figure 57: "Timer" function	81
Figure 58: Function value transmitter 1 byte/2 byte	82
Figure 59: Value 2 bytes function	83
Figure 60: Priority function	84
Figure 61: Scene function	86
Figure 62: Deactivate automatic function	88
Figure 63: Automatic control function with switching/toggle commands	89
Figure 64: Automatic control function with roller shutter/blind commands	90
Figure 65: Push-button - Blocking function	91
Figure 66: Reset	92
Figure 67: Info	93
Figure 68: Info	93
Figure 69: Timer program	94
Figure 70: Page No problem, display	95

Application description

KNX thermostat
KNX room controller



List of tables

Table 1: ETS Software version	5
Table 2: ETS Application designations	5
Table 3: Selection device variant	13
Table 4: General Settings	16
Table 5: User messages	19
Table 6: Time	20
Table 7: Page "Basic display"	22
Table 8: State of the house	25
Table 9: Priority Status message/User message	26
Table 10: Examples Status messages	27
Table 11: Blocking function	28
Table 12: Time setting for long push-push-button action	29
Table 13: Settings "General - Room thermostat"	32
Table 14: Settings "General - Room thermostat - Heating"	33
Table 15: Mode selection change-over via object with presence object	37
Table 16: Mode selection change-over via object with presence object with presence detector	38
Table 17: Mode selection switch-over via object (1 byte) with priority of 2-bit object	39
Table 18: Room thermostat - Basic heating	46
Table 19: Room thermostat - Additional heating	48
Table 20: Room thermostat - Basic cooling	49
Table 21: Room thermostat - Additional cooling	52
Table 22: Temperature measurement settings	56
Table 23: Function "FanCoil"	59
Table 24: Fan speed "Switching object 1-bit"	60
Table 25: Fan speed "Value object" (1 byte)	61
Table 26: Transmission settings	62
Table 27: Setpoint Settings	64
Table 28: Room thermostat "Basic display"	65
Table 29: Scene settings	66
Table 30: Internal temperature sensor settings	67
Table 31: External temperature sensor settings	69
Table 32: Settings of push-push-button functions	71
Table 33: Toggle switch function	73
Table 34: Function switching	74
Table 35: Function dimming	76
Table 36: Function shutter	78
Table 37: Function blind	79
Table 38: Timer	81
Table 39: Value transmitter 1-byte function	82
Table 40: Value 2 bytes function	83
Table 41: Priority function	84
Table 42: Priority behaviour	84
Table 43: Structure of 1-byte scene object	86

Application description

KNX thermostat

KNX room controller



Table 44: Scene function	86
Table 45: Automatic function	88
Table 46: ETS software characteristics	96