

Technical Manual

MDT Room Temperature Controller

SCN-RT1UP.01

SCN-TS1UP.01

SCN-RT1UPE.01

SCN-RT1APE.01



1 Content

1 Content.....	2
2 Overview.....	4
2.1 Overview devices.....	4
2.2 Usage & Areas of use.....	4
2.3 Exemplary circuit diagram.....	5
2.4 Structure & Handling.....	5
2.5 Functions.....	6
2.5.1 Overview functions.....	7
2.6 Settings at the ETS-Software.....	8
2.7 Starting up.....	8
3 Communication objects.....	9
3.1 Default settings of the communication objects.....	9
4 Reference ETS-Parameter.....	11
4.1 General Settings.....	11
4.2 Temperature measurement.....	12
4.3 Alarm/Messages.....	14
4.4 Controller general.....	16
4.4.1 Controller type.....	16
4.4.2 Operating modes & Setpoints.....	17
4.4.3 Setpoint offset.....	23
4.4.4 Blocking objects.....	25
4.4.5 Heating/Cooling request objects.....	26
4.4.6 Guiding.....	27
4.4.7 Dead zone.....	29
4.5 Controller settings.....	31
4.5.1 Control value.....	31
4.5.2 PI control continuous.....	32
4.5.3 PI control switching (PWM).....	35
4.5.4 2-step control (switching).....	37
4.5.5 Direction of controller.....	39
4.5.6 Additional level.....	39
4.5.7 Additional settings for heating and cooling.....	42

5 Index.....	46
5.1 Register of Illustrations	46
5.2 List of tables.....	47
6 Attachment.....	48
6.1 Statutory requirements.....	48
6.2 Routine disposal	48
6.3 Assemblage.....	48
6.4 Controller.....	49
6.4.1 2-Step control.....	49
6.4.2 PI-control continuous	50
6.4.3 PI-control switching (PWM)	51
6.5 Direction of controller	52
6.6 Datasheet	52

2 Overview

2.1 Overview devices

The manual refers to the following devices, which are in our assortment of room temperature controller (Order Code respectively printed in bold type):

- **SCN-RT1UP.01** Room temperature controller UP
 - integrated temperature controllers: Two-position, PI, PWM; flush mounted
- **SCN-RT1APE.01** Room temperature controller AP with adjustment knob
 - integrated temperature controllers: Two-position, PI, PWM; surface mounted; with adjustment knob
- **SCN-RT1UPE.01** Room temperature controller UP with adjustment knob
 - integrated temperature controllers: Two-position, PI, PWM; flush mounted; with adjustment knob
- **SCN-TS1UP.01** Room temperature sensor 1-fold
 - Sensor for measuring the room temperature, without controller function

2.2 Usage & Areas of use

The room temperature controller has its areas of use at the controlling in home installations and in the object range.

A lot of different controls can be realized by the room temperature controller. There are three integrated controllers, which can be adjusted to the present system. The three controllers can control as well heating systems as cooling systems. There are setting options for up to 4 different operating modes. Additional levels, blocking functions, settings of external sensors and guiding can also be adjusted.

An exception is the SCN-TS1UP.01. The SCN-TS1UP.01 is only a sensor for measuring the temperature. There are no integrated temperature controllers at this device. The temperature sensor has its areas of use at the measuring of temperatures for other controllers.

2.3 Exemplary circuit diagram

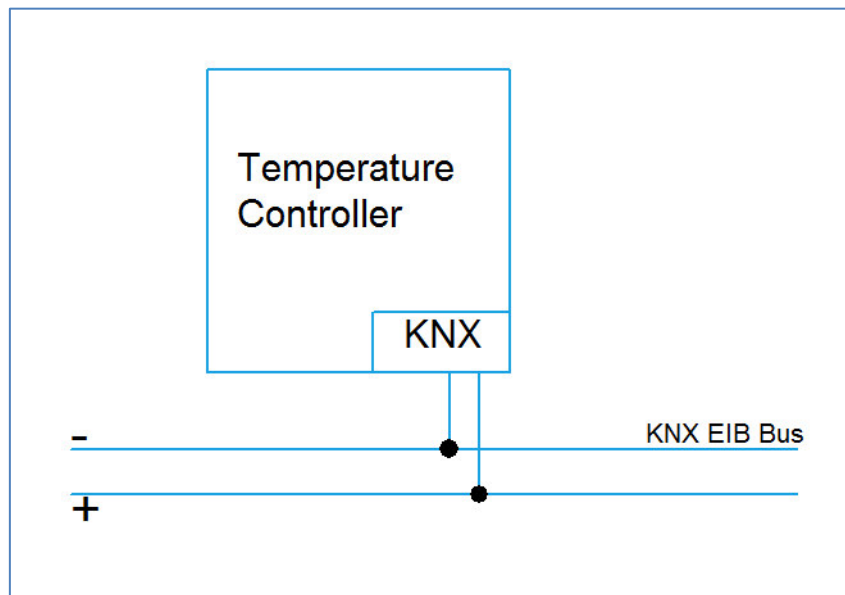

Figure 1: Exemplary circuit diagram

2.4 Structure & Handling

The room temperature controller is available in three different designs. There are designs for flush-mounting and surface-mounting.

All of the devices contain of a bus-connection, a programming button and a programming LED at the back.

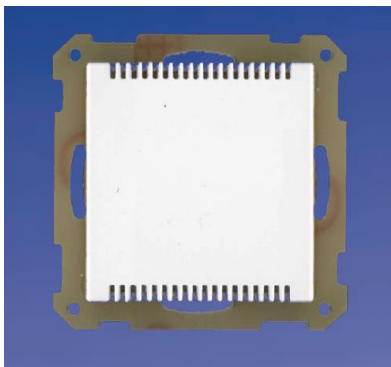

Figure 2: SCN-RT1UP.01



Figure 3: SCN-RT1APE.01

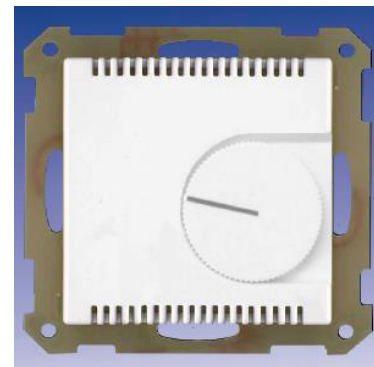

Figure 4: SCN-RT1UPD.01

The room temperature sensor, SCN-TS1UP.01, is for flush-mounting. It contains also of a bus-connection, a programming button and a programming LED.

2.5 Functions

All room temperature controllers can measure a temperature and send a control variable. The controller has 5 different sub-menus. At every sub menu, different settings can be made. The sub menus are structured in this way:

- **Setup general**
General settings can be made at this menu and the used device can be chosen.
- **Temperature measurement**
The settings for the measurement for the temperature can be made at this menu. Settings for the min/max values and the sensor configuration are available at this parameter.
All sensors contain of an in-plant balance.
- **Alarm/Messages**
Alarms and messages can be adjusted at this menu. This alarms and messages report when the temperature falls below an adjusted value or exceed an adjusted value.
- **Controller general**
At this menu, the desired function (heating, cooling or heating & cooling) can be assigned and general settings, like setpoints, can be adjusted.
- **Controller settings**
This menu appears as soon as the controller has got a function assigned. Integrated controllers can be chosen at this menu and the chosen controller can be parameterized further.

If you choose the SCN-TS1UP.01 as device at the setup general, only the menus setup general, temperature measurement and alarm/messages will be shown.

2.5.1 Overview functions

Setup general	Startup delaytime	delaytime after turn on of the bus power
	Hardware selection	Adjustment of the used device
Temperature measurement	Send actual value	<ul style="list-style-type: none"> • can be switched on/off • report condition for change of temperature adjustable from 0,1K to 2Kr
	Send actual value cyclic	<ul style="list-style-type: none"> • can be switched on/off • times of sending adjustable
	Min/max values	<ul style="list-style-type: none"> • report can be switched on/off • can be reset manual by communication object
	Sensor configuration	<ul style="list-style-type: none"> • additional connection of an external sensor possible • balance internal/external sensor adjustable • balance worth for internal sensor adjustable
Alarm/Messages	Alarms	<ul style="list-style-type: none"> • can be switched on/off • Frost-/Heat alarm
	Messages	<ul style="list-style-type: none"> • can be switched on/off • Report condition of the Min/Max temperatures parameterize able
Controller general	Controller type	<ul style="list-style-type: none"> • Heating • Cooling • Heating & Cooling
	Priority	Order of the operating modes adjustable
	Basis-Setpoint	Reference point of the temperature control
	Setpoints	Reference points for operating modes and controller modes parameterize able
	Shift of setpoints	<ul style="list-style-type: none"> • Max. shift parameterize able • Scope of the shift parameterize able • can be saved
	Blocking objects	can be used for heating and cooling separately
	Guiding	<ul style="list-style-type: none"> • can be switched on/off • Min/Max Values parameterize able • impact to setpoint parameterize able

Controller settings	Integrated controller	<ul style="list-style-type: none"> • 2 step control <ul style="list-style-type: none"> ○ Hysteresis parameterize able • PI-control continuous <ul style="list-style-type: none"> ○ Max. value of control variable ○ Setting of used system ○ free parameterization of specific values available • PI control switching (PWM) <ul style="list-style-type: none"> ○ Max. value of control variable ○ Setting of used system ○ free parameterization of specific values available ○ PWM-cycletime parameterize able • Additional levels available
	Switch over heating/cooling	<ul style="list-style-type: none"> • automatically • via object
	Direction of controller	<ul style="list-style-type: none"> • normal • inverted

Table 1: Functional overview

2.6 Settings at the ETS-Software

Selection at the product database:

Manufacturer: MDT Technologies

Product family: Control System

Product type: Room temperature controller

Medium Type: Twisted Pair (TP)

Product name: addicted to the used type, e.g.: SCN-RT1xPx.xx

Order number: addicted to the used type, e.g.: SCN-RT1UP.01

2.7 Starting up

After wiring the allocation of the physical address and the parameterization of every channel follow:

- (1) Connect the interface with the bus, e.g. MDT USB interface
- (2) set bus power up
- (3) Press the programming button at the device (red programming LED lights)
- (4) Loading of the physical address out of the ETS-Software by using the interface (red LED goes out, as well this process was completed successful)
- (5) Loading of the application, with requested parameterization
- (6) Switch the power supply on
- (7) If the device is enabled you can test the requested functions (also possible by using the ETS-Software)

3 Communication objects

3.1 Default settings of the communication objects

The following chart shows the default settings for the communication objects:

Default settings									
Nr.	Channel/Input	Function	Length	Priority	C	R	W	T	U
0	Actual temperature value	Transmit temperature value	2 Byte	Low	X	X		X	
1	Higher message value	Send message	1 Bit	Low	X	X		X	
2	Lower message value	Send message	1 Bit	Low	X	X		X	
3	Frost alarm	Send alarm	1 Bit	Low	X	X		X	
4	Heat alarm	Send alarm	1 Bit	Low	X	X		X	
5	External sensor	Read external sensor	2 Byte	Low	X		X		
6	Setpoint comfort	Set setpoint	2 Byte	Low	X	X	X	X	
7	Manual setpoint value offset	Reduction/Increase	2 Byte	Low	X		X		
8	Control value heating	Send control value	1 Bit	Low	X	X		X	
8	Control value heating	Send control value	1 Byte	Low	X	X		X	
8	Control value heating/cooling	Send control value	1 Bit	Low	X	X		X	
8	Control value heating/cooling	Send control value	1 Byte	Low	X	X		X	
9	Control value additional heating	Send control value	1 Bit	Low	X	X		X	
10	Control value cooling	Send control value	1 Bit	Low	X	X		X	
10	Control value cooling	Send control value	1 Byte	Low	X	X		X	
11	Mode comfort	Switch mode	1 Bit	Low	X	X	X		
12	Mode night	Switch mode	1 Bit	Low	X	X	X		
13	Mode frost/heat protection	Switch mode	1 Bit	Low	X	X	X		
14	Heating disable object	Disable heating	1 Bit	Low	X		X		
15	Cooling disable object	Disable cooling	1 Bit	Low	X		X		
17	Heating request	Send request	1 Bit	Low	X	X		X	
18	Cooling request	Send request	1 Bit	Low	X	X		X	
19	Heating/Cooling switchover	0=Heating 1=Cooling	1 Bit	Low	X		X		

20	Guiding value	Setpoint adjustment	2 Byte	Low	X	X	X		
21	Max memory value	Read memory	2 Byte	Low	X	X	X	X	
22	Min memory value	Read memory	2 Byte	Low	X	X	X	X	
23	Min/Max memory reset	Reset memory	1 Bit	Low	X		X	X	
24	Reset setpoint value	Parameter read in	1 Bit	Low	X		X		
25	DPT_HVAC Status*	Send controller status	1 Byte	Low	X	X		X	
28	Error external Sensor	Error message	1 Bit	Low	X	X		X	
29	Actual setpoint	Send setpoint	2 Byte	Low	X	X		X	
30	DPT_RHCC*	Send controller status	2 Byte	Low	X	X		X	
31	Mode selection	Select mode	1 Byte	Low	X		X	X	

Table 2: Communication objects – default settings

You can see the default values for the communication objects from the upper chart. According to requirements the priority of the particular communication objects as well as the flags can be adjusted by the user. The flags allocates the function of the objects in the programming thereby stands C for communication, R for Read, W for write, T for transmit and U for update.

* from version 1.2

4 Reference ETS-Parameter

4.1 General Settings

The following settings are available at the ETS-Software:

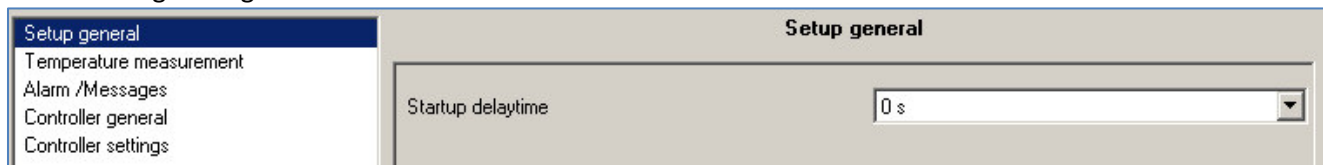

Figure 5: General settings

The chart shows the dynamic range of the general settings:

ETS-text	Dynamic range [default value]	comment
Startup delaytime	0-60s [0]	Time between an upload and the functional start of the device

Table 3: General settings

The parameter startup timeout adjusts the time between an upload and the functional start of the device. The used hardware reacts only after expiration of the adjusted time. All input commands before the startup timeout expire.

The **SCN-TS1UP.01** is a pure temperature sensor, which does not contain of any controller functions. When this hardware is selected, only the menus “Setup general”(4.1), “Temperature measurement” (4.2) and “Alarm/Messages” (4.3) are shown and can be parameterized.

4.2 Temperature measurement

The following settings are available at the ETS-Software:

Temperature measurement

Send actual value after change of	0,2 K
Send actual temperature cyclically	1 min
Send min/max value	Send enable
Internal sensor correction value (value * 0.1K)	0
Internal/external sensor	50 % intern / 50 % extern

Figure 6: Temperature measurement

The chart shows the dynamic range of the available parameters:

ETS-text	Dynamic range [default value]	comment
Send actual value after change of	<ul style="list-style-type: none"> ▪ disable ▪ 0,1K - 2,0K 	Sending condition for the actual temperature value
Send actual temperature cyclically	<ul style="list-style-type: none"> ▪ disable ▪ 1 min – 60 min 	Activation of the cyclically sending of the temperature value
Send min/max value	<ul style="list-style-type: none"> ▪ disable ▪ Send enable 	Activation of the sending of min/max values
Internal sensor correction value (value*0,1K)	-50 – 50 [0]	Correction of the internal sensor
Internal/external sensor	<ul style="list-style-type: none"> ▪ 100% intern ▪ 90% intern/ 10% extern ▪ 80 % intern/ 20% extern ▪ ... ▪ 100% extern 	Adjustment of the balance between internal and external sensor

Table 4: Parameter Temperature measurement

The effects of the settings are described at the following page.

- **Send actual value after change of**
 This functions sets when the current temperature value shall be sent. By choosing the setting “disable”, no value will be sent at all.
- **Send actual temperature cyclically**
 You can activate this function by choosing a time. Now, the room temperature controller sends the current temperature periodically after the adjusted time. This function is independent from the function “Send actual value after change of”. So the temperature controller will send its current value also if there is no change of it.
- **Internal sensor correction value (value*0,1K)**
 You can correct the measured temperature value by this setting. By choosing a negative value for this parameter, the measured value will be lowered and by choosing a positive value, the measured value will be lifted. The value is multiplied by 0,1K, so the current value can be lowered or lifted up to 5K. This setting is useful, when the sensor was built at an unfavorable location, e.g. becoming draft or next to a window. When this function is activated, the temperature controller will also send the corrected values.
 All sensors are matched in-plant to 0,1K.

The chart shows the relevant communication object for the temperature value:

Number	Name	Length	Usage
0	Actual temperature value	2 Byte	sends the current temperature value

Table 5: Communication object temperature value

- **Send min/max value**
 This function activates the sending and saving of the min/max values. When the function is activated by “Send enable”, three communication objects will be shown. Two objects for the Min and the Max value and one for the reset of the min/max values.

The chart shows the relevant communication objects for this parameter:

Number	Name	Length	Usage
21	Max memory value	2 Byte	sends and saves the maximal temperature value
22	Min memory value	2 Byte	sends and saves the minimal temperature value
23	Min/Max memory reset	1 Bit	resets the min/max values

Table 6: Communication objects Min/Max values

- **Internal/external sensor**
 This setting sets the balance between an internal and an external sensor. The setting 100% intern deactivates any external sensor. By choosing any other setting, an external sensor will be activated. So, also communication objects for the external are shown. A balance of 100% extern deactivates the internal sensor and the temperature controller will only note values of the external sensor.

The communication objects for an activated external sensor are shown at the chart:

Number	Name	Length	Usage
5	External sensor	2 Byte	sends the measured temperature value of the external sensor
28	Error external sensor	1 Bit	sends an error, when the external sensor sends no value for more than 30min

Table 7: Communication objects external sensor

4.3 Alarm/Messages

The following settings are available at the ETS-Software:

Alarm /Messages

Alarm	Active ▼
Frostalarm if value <	7 °C ▼
Heatalarm if value >	35 °C ▼
Messages	Active ▼
Message if value >	26 °C ▼
Message if value <	13 °C ▼

Figure 7: Alarm/Messages

The chart shows the dynamic range of the alarm and messages:

ETS-text	Dynamic range [default value]	comment
Alarm	<ul style="list-style-type: none"> ▪ not active ▪ active 	Activation of the alarm function
Frostalarm if value <	3°C-10°C [7°C]	Dynamic range of the frostalarm Adjustment possible if alarm is activated
Heatalarm if value >	25°C-40°C [35°C]	Dynamic range of the heatalarm Adjustment possible if alarm is activated
Messages	<ul style="list-style-type: none"> ▪ not active ▪ active 	Activation of the message function
Message if value >	18°C-40°C [26°C]	Dynamic range of the upper message Adjustment possible if messages are activated
Message if value <	1°C-25°C [13°C]	Dynamic range of the lower message Adjustment possible if messages are activated

Table 8: Parameter Alarm/Messages

- **Alarm**

There are two parameterize able alarms, when the alarm function was activated. The frostalarm is for the notification of the lower temperatures and the heatalarm for the notification of the upper temperatures. Both alarms have a separate communication object with the size of 1 Bit.

The chart shows the relevant communication objects for the alarms:

Number	Name	Length	Usage
3	Frostalarm	1 Bit	send frostalarm
4	Heatalarm	1 Bit	send heatalarm

Table 9: Communication objects alarm

- **Messages**

The message function is almost identical to the alarm function, but less in its priority. There are two messages available, when the message function was activated. These two messages can be parameterized separately. The dynamic range of the message function is much bigger than the one of the alarm function. So it is also possible, to realize running turn over. Both messages have an own communication object of the size 1 bit. These communication objects are shown in the chart below:

Number	Name	Length	Usage
1	Higher message value	1 Bit	Send the achievement of the higher reporting limit
2	Below message value	1 Bit	Send the achievement of the lower reporting limit

Table 10: Communication objects messages

4.4 Controller general

4.4.1 Controller type

The following settings are available at the ETS-Software:



Figure 8: Setting controller type

The chart shows the dynamic range of the controller type:

ETS-text	Dynamic range [default value]	comment
Controller type	<ul style="list-style-type: none"> ▪ Controller off ▪ Heating ▪ Cooling ▪ Heating and Cooling 	<p>Adjustment of the controller type</p> <p>The further settings depend to the adjusted controller type</p>

Table 11: Setting controller type

The controller type defines the function of the room temperature controller. Target of the control is to keep an adjusted temperature constant. There are a lot of settings, which can help to achieve this aim. The settings depend to the adjusted controller type.

By choosing the setting “controller off”, no further settings are possible.

4.4.2 Operating modes & Setpoints

The following settings are available at the ETS-Software:

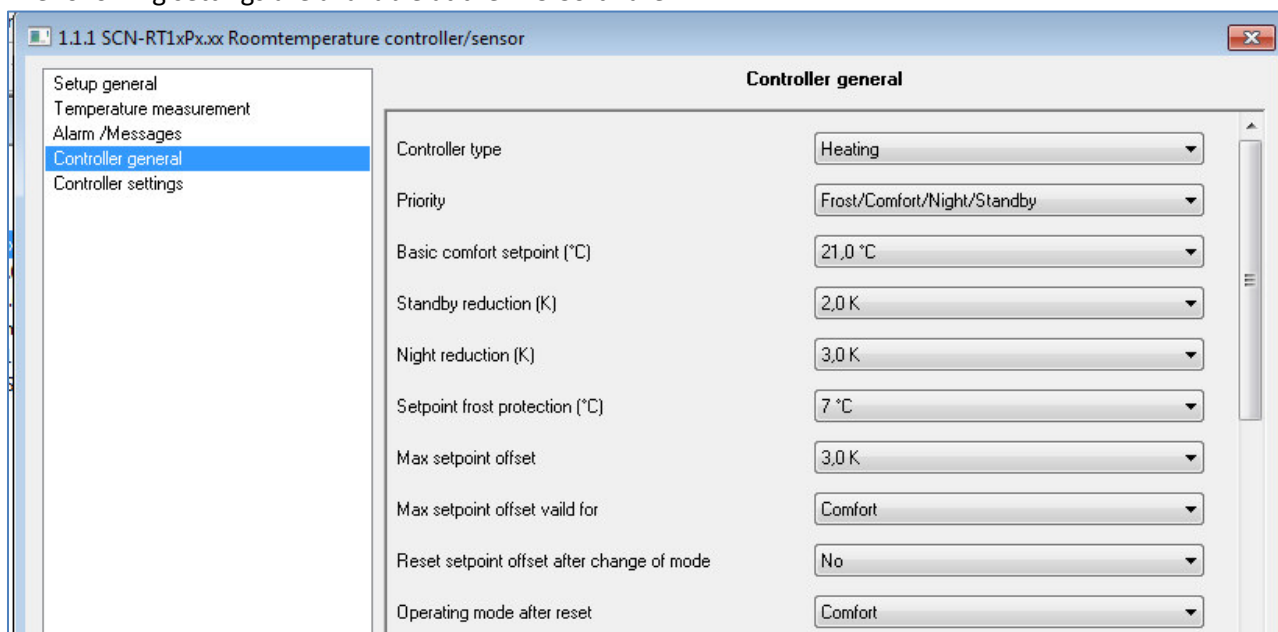

Figure 9: Operating modes & setpoints

The chart shows the dynamic range of the operating modes and setpoints:

ETS-text	Dynamic range [default value]	comment
Basis comfort setpoint	18,0°C – 25,0°C [21,0°C]	The basis comfort setpoint is the reference point of the control.
Night reduction	Lowering in K 0 K – 10,0 K [3,0 K]	Lowering of the temperature by choosing the operating mode night. Relative to the basis comfort setpoint.
Standby reduction	Lowering in K 0 K – 10,0 K [2,0 K]	gets activated when no other operating mode was chosen The lowering is relative to the basis comfort setpoint.
Setpoint frost protection	3°C – 12°C [7°C]	Setpoint of the operating mode frost protection. indicated by an absolute value
Setpoint heat protection	24°C – 40°C [35°C]	Setpoint of the operating mode heat protection. indicated by an absolute value

Table 12: Operating modes & setpoints

4.4.2.1 Operating mode Comfort

The operating mode comfort is the reference mode of the controller. The temperature reduction at the operating modes night and standby refer to the setpoint of the comfort mode. When a room is used, the operating mode comfort should be activated. The configured setpoint, the “basic comfort setpoint, is valid for the heating process if the controller was set as heating & cooling (described at 4.4.7).

The chart shows the relevant 1-Bit communication object:

Number	Name	Length	Usage
11	Mode comfort	1 Bit	Activation of the operating mode comfort

Table 13: Communication object operating mode comfort

4.4.2.2 Operating mode Night

The operating mode night shall cause a significant decrement of the temperature, for example at night or at the weekend. The reduction can be programmed freely and refers to the basic comfort setpoint. If you have programmed a reduction of 5K and a basic comfort setpoint of 21°C, the setpoint for the night mode will be 16°C.

The chart shows the relevant 1-Bit communication object:

Number	Name	Length	Usage
12	Mode night	1 Bit	Activation of the operating mode night

Table 14: Communication object operating mode night

4.4.2.3 Operating mode Standby

When nobody is in the room, the operating mode standby is used. This operating mode shall cause a low reduction of the temperature. So the room can be heated up fast again.

The value for the reduction can be programmed freely and refers to basic comfort setpoint. If you have adjusted a reduction of 2K and a basic comfort setpoint of 21°C, the setpoint for the operating mode standby will be 19°C.

The standby mode cannot be activated by a certain communication object. It gets activated, when all operating modes are switched off.

4.4.2.4 Operating mode Frost/Heat protection

The operating mode frost protection gets activated, when the controller type was set as heating. The heat protection gets activated, when the controller type was set as cooling. When the controller type is set to heating and cooling, the combined operating mode frost-/ heat protection is activated.

This operating mode causes an automatically switch on of heating or cooling, when a parameterized is exceeded or the temperature falls below a parameterized temperature. At this operating mode, the temperature is set as absolute value. You should activate this function if you are longer absent and the temperature must not fall below a specific value or exceed a specific value.

The chart shows the relevant 1-Bit communication objects:

Number	Name	Length	Usage
13	Mode frost protection	1 Bit	Activation of the operating mode frost protection
13	Mode heat protection	1 Bit	Activation of the operating mode heat protection
13	Mode frost/heat protection	1 Bit	Activation of the operating mode frost/heat protection

Table 15: Communication object operating mode frost/heat protection

4.4.2.5 Priority of the operating modes

The following settings are available at the ETS-Software:

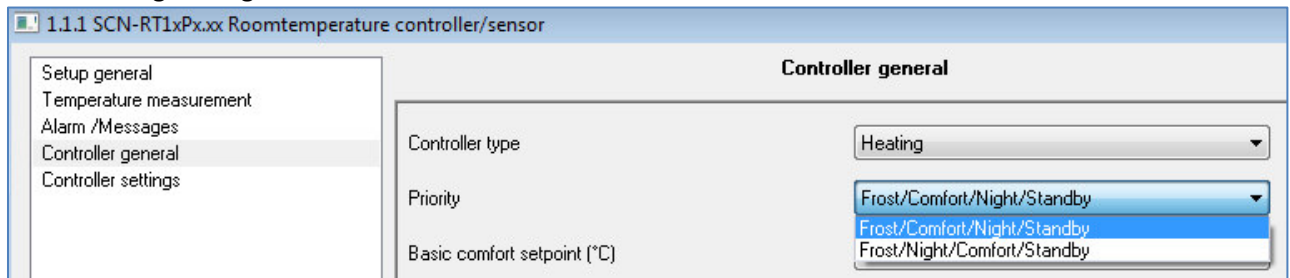

Figure 10: Priority of the operating modes

The chart shows the dynamic range of the priority of the operating modes:

ETS-text	Dynamic range [default value]	comment
Priority	<ul style="list-style-type: none"> ▪ Frost/Comfort/Night/Standby ▪ Frost/Night/Comfort/Standby 	Adjustment of the priority of the operating modes

Table 16: Priority of the operating modes

The setting of the priority enables to adjust which operating mode shall be switched primarily when more than one operating mode is switched on. At the priority of Frost/Comfort/Night/Standby, the comfort mode will be switched on even if comfort and night is switched on to the same time. The night mode will only be active, when the comfort mode is switched off. now the controller changes automatically to the night mode.

4.4.2.6 Operating mode switchover

There are 2 possibilities for the switchover of the operating modes: On the one hand the operating modes can be switched on by their 1 Bit communication object and on the other hand by a 1 Byte object (from Version 1.2).

The selection of the operating modes by their 1 Bit communication object occurs via a direct selection of their individual communication object. With consideration of the adjusted priority, the operating mode, which was selected via the 1 Bit communication object, is switched on or off. When all operating modes are switched off, the controller changes to the standby mode.

Example:

The priority was set as Frost/Comfort/Night/Standby.

Operating mode				adjusted operating mode
Comfort	Night	Frost-/ Heat protection		
1	0	0		Comfort
0	1	0		Night
0	0	1		Frost-/Heat protection
0	0	0		Standby
1	0	1		Frost-/Heat protection
1	1	0		Comfort

Table 17: Example switchover of the operating modes via 1 Bit

The switchover of the operating modes via 1 Byte occurs by only one object, with the size of 1 Byte, the DPT_HVAC Mode 20.102 of KNX-specification. Additional, there are 2 objects for the visualization available, the 1 Byte object "DPT_HVAC Status" and the 2 Byte object "DPT_RHCC Status". For the switchover of the operating modes, a Hex-value is sent to the object "mode selection". The object evaluates the received value and switches the belonging operating mode on and the active operating mode off. If all operating modes are switched off (Hex-value=0), the operating mode standby will be switched on.

The Hex-values for the operating modes are shown at the chart:

Operating mode (HVAC Mode)	Hex-Value
Comfort	0x01
Standby	0x02
Night	0x03
Frost/Heat protection	0x04

Table 18: Hex-Values for operating modes (from Version 1.2)

The following example shall clarify how the controller handles received Hex-values and switches operating modes on or off. The chart is to read from the top to the down.

Example:

The priority was set as Frost/Comfort/Night/Standby.

received Hex-value	Handling	adjusted operating mode
0x01	Comfort=1	Comfort
0x03	Comfort=0 Night=1	Night
0x02	Night=0 Standby=1	Standby
0x04	Frost-/Heat protection=1 Standby=0	Frost-/Heat protection

Table 19: Example operating mode switchover via 1 Byte (from Version 1.2)

The DPT HVAC Status communication, DPT_HVAC Status (without number) of KNX-specification, object sends the hex value for the adjusted operating mode. When more than one testify is valid, the hex values are added and the communication object sends the added value. The hex values can be read from visualization afterwards.

The following chart shows the hex values for the single messages:

Bit	DPT HVAC Status		Hex-Value
0	Comfort	1=Comfort	0x01
1	Standby	1=Standby	0x02
2	Night	1=Night	0x04
3	Frost-/Heat protection	1= Frost-/Heat protection	0x08
4			
5	Heating/Cooling	0=Cooling/1=Heating	0x20
6			
7	Frost alarm	1=Frost alarm	0x80

Table 20: Hex-Values DPT HVAC Status (from Version 1.2)

If you heat at the comfort mode, the communication object will send the value 20 (for heating) +1 (for the comfort mode) =21.

The DPT RHCC Status object is an additional 2 Byte status object with additional status messages. If more than one testify is valid, also here the values will be added in the same way as at the HVAC object.

The following chart shows the hex values for the single messages:

Bit	DPT RHCC Status		Hex-Value
0	Error Sensor	1=Error	0x01
8	Heating/Cooling	0=Cooling/1=Heating	0x100
13	Frost alarm	1=Frost alarm	0x2000
14	Heat alarm	1=Heat alarm	0x4000

Table 21: Hex-Values DPT RHCC Status (from Version 1.2)

The Controller reacts always to the value, which was sent last. If you switched the operating mode last via 1 Bit, the controller will react to the switchover by 1 Bit. If you switched the operating mode last via 1 Byte, the controller will react to the switchover by 1 Byte.

The communication objects for the mode selection are shown at the following chart. The first 3 communication objects are for the 1 Bit switchover, the last 3 objects are for the switchover via 1 Byte:

Number	Name	Length	Usage
11	Mode Comfort	1 Bit	Activation of the mode comfort
12	Mode Night	1 Bit	Activation of the mode night
13	Mode Frost/Heat protection	1 Bit	Activation of the mode Frost/ Heat protection
25	DPT_HVAC Status*	1 Byte	Visualization of the chosen operating mode
30	DPT_RHCC Status*	2 Byte	Visualization measuring/ status of the controller
31	mode selection*	1 Byte	Selection of the operating mode

Table 22: Communication objects for the operating mode switchover

* from Version 1.2

4.4.2.7 Operating mode after reset

The following settings are available at the ETS-Software:



Figure 11: Operating mode after reset

The following chart shows the dynamic range for this parameter:

ETS-text	Dynamic range [default value]	comment
Operating mode after reset	<ul style="list-style-type: none"> ▪ Comfort with parameterized set point ▪ Standby with parameterized set point ▪ Hold old state and set point 	Adjustment, which operating mode shall be switched on after a bus power return

Table 23: Operating mode after reset

This parameter defines the operating mode, which shall be adjusted after a bus power return. The controller can start with the comfort mode or with the standby mode. In both cases, the parameterized set point will be restored. By using setting “Hold old state and set point”, the controller restores the old operating mode and the set point, which was active before the reset. It must be pointed out, that the controller has no settings in its memory in case of an initial operation.

4.4.3 Setpoint offset

The following settings are available at the ETS-Software:

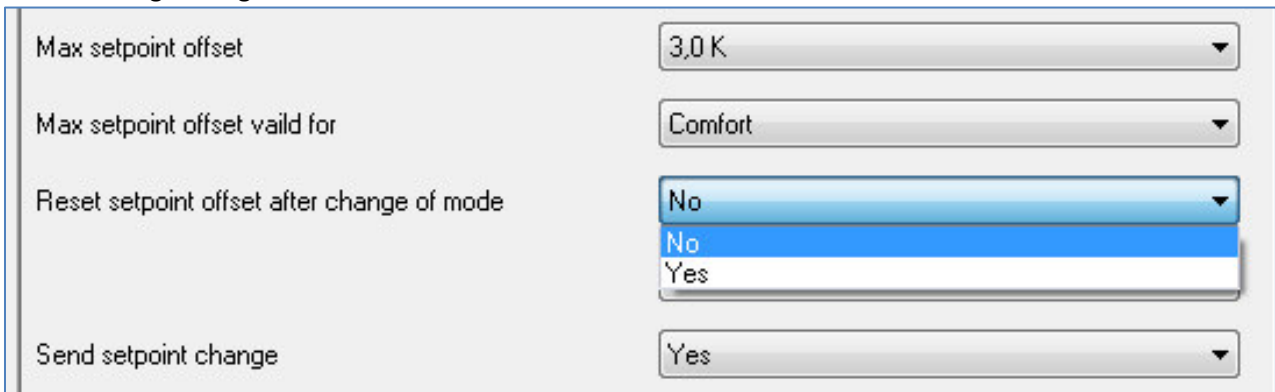

Figure 12: Setpoint offset

The following chart shows the dynamic range for this parameter:

ETS-text	Dynamic range [default value]	comment
Max setpoint offset	0K – 10,0K [3,0K]	indicates the maximal offset
Max setpoint offset valid for	<ul style="list-style-type: none"> ▪ Comfort ▪ Comfort/Night/Standby 	scope of the setpoint offset
Reset setpoint offset after change of mode	<ul style="list-style-type: none"> ▪ No ▪ Yes 	Adjustment, whether a setpoint offset is still valid after change of operating mode or not
Send setpoint change	<ul style="list-style-type: none"> ▪ No ▪ Yes 	Adjustment, whether a change of mode should be send or not

Table 24: Setpoint offset

The setpoint can be changed manual by the setpoint offset without a new parameterization by the ETS-Software. Therefore, 2 variants are available. On the one hand a new setpoint can be pretended by the communication object "Setpoint comfort". On the other hand the adjusted setpoint can be increased or decreased manual by the communication object "manual setpoint value offset". At the read in of a new absolute comfort setpoint, the controller becomes a new basis comfort setpoint. The new basic comfort setpoint causes also an adaption of the indirect setpoints at the other operating modes. Through this function it is for example possible to read the actual room temperature as new basic comfort setpoint in. The settings "max setpoint offset", "max setpoint offset valid for" and "Reset setpoint offset after change of mode" are not valid at this variant of setpoint offset, because the controller becomes a complete new setpoint. Specifying a new value is possible by calling the object "Setpoint comfort".

The second opportunity of the manual setpoint offset is the movement of the setpoint depending to the current adjusted setpoint. For this variant of setpoint offset, the object “manual setpoint value offset” is used. Sending a positive Kelvin value at this object causes an increment of the current setpoint. Sending a negative Kelvin value at this object causes a decrement of the current setpoint. By activating the Setpoint offset with setwheel at the device-specification with setwheel, the communication object number 7 “manual setpoint offset change” disappears. The manual setpoint offset is performed by the setwheel now (have a look at 4.1.1).

The setting “max setpoint offset” indicates the maximal possible setpoint movement. If the controller is for example set to a basic comfort setpoint of 3K, the setpoint can only be moved manual in the limits of 18°C and 24°C.

The setting “max setpoint offset valid for” defines the scope of the setpoint offset. You can choose whether the setpoint offset is only valid for the comfort mode or also for the night and standby mode. The operating mode frost/ heat protection is always independent of the setpoint offset. The setting „Reset setpoint after change of mode” indicates whether a setpoint offset shall be maintained after a change of mode or not. If this parameter is deactivated, the device will switch to the adjusted setpoint for the chosen operating mode after every change of mode.

The communication object “Actual setpoint” is for the query of the current setpoint at the actual adjusted operating mode.

The following chart shows the relevant communication objects:

Number	Name	Length	Usage
6	Setpoint comfort	2 Byte	Parameterization of a new absolute comfort setpoint
7	Manual setpoint value offset	2 Byte	Movement of the setpoint depending to the current adjusted basic comfort setpoint
29	Actual setpoint	2 Byte	Readout of the actual adjusted setpoint

Table 25: Communication objects setpoint offset

4.4.4 Blocking objects

The following settings are available at the ETS-Software:

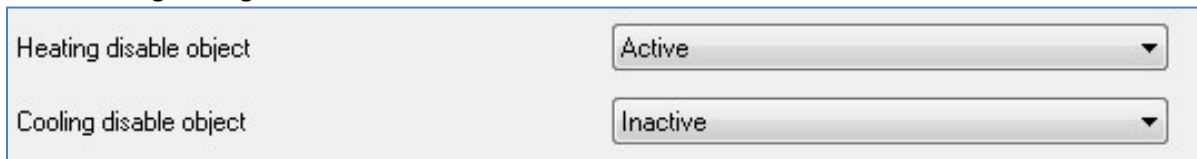

Figure 13: Blocking objects

The following chart shows the dynamic range for this parameter:

ETS-text	Dynamic range [default value]	comment
Heating disable object	<ul style="list-style-type: none"> ▪ Inactive ▪ Active 	activates the blocking object for the heating process
Cooling disable object	<ul style="list-style-type: none"> ▪ Inactive ▪ Active 	activates the blocking object for the cooling process

Table 26: Blocking objects

Depending to the adjusted controller type, one or two blocking objects are available. The blocking objects disable the control value. The blocking objects can be used when the heating or cooling system shall be prevented of an unwanted start.

If the heating must not start at special situations, for example when a window is opened, the blocking object can be used. Another usage of this function is for example the manual blocking, for example by a push button, in case of a cleaning process.

The blocking objects have the size of 1 Bit and blocks by sending a logical 1 at the depending communication object.

The chart shows the relevant communication objects:

Number	Name	Length	Usage
14	Heating disable object	1 Bit	blocks the control value heating
15	Cooling disable object	1 Bit	blocks the control value cooling

Table 27: Communication objects blocking objects

4.4.5 Heating/Cooling request objects

The following settings are available at the ETS-Software:

Heating request object enabled	No
Cooling request object enabled	Yes

Figure 14: Heating/Cooling request objects

The following chart shows the dynamic range for this parameter:

ETS-text	Dynamic range [default value]	comment
Heating request object enabled	<ul style="list-style-type: none"> ▪ No ▪ Yes 	activates the communication object for the visualization of a beginning heating process
Cooling request object enabled	<ul style="list-style-type: none"> ▪ No ▪ Yes 	activates the communication object for the visualization of a beginning cooling process

Table 28: Heating/Cooling request objects

The setting “Heating/Cooling request enabled” can show objects, which indicates a beginning heating or cooling process. So these objects are status objects.

The objects can be used for the visualization of a beginning or ending heating/cooling process. So, for example, a red LED could show a heating process and a blue LED a cooling process.

A further opportunity for the usage is the central switch of a heating or cooling process. So can be realized that all heating devices of a building switch on, when a controller gives out a heating request.

The 1 Bit communication object gives as long a 1-signal out as the process is active.

The following chart shows the relevant communication objects:

Number	Name	Length	Usage
17	Heating request	1 Bit	indicates a beginning heating process
18	Cooling request	1 Bit	indicates a beginning cooling process

Table 29: Communication objects heating/cooling request

4.4.6 Guiding

The following settings are available at the ETS-Software:

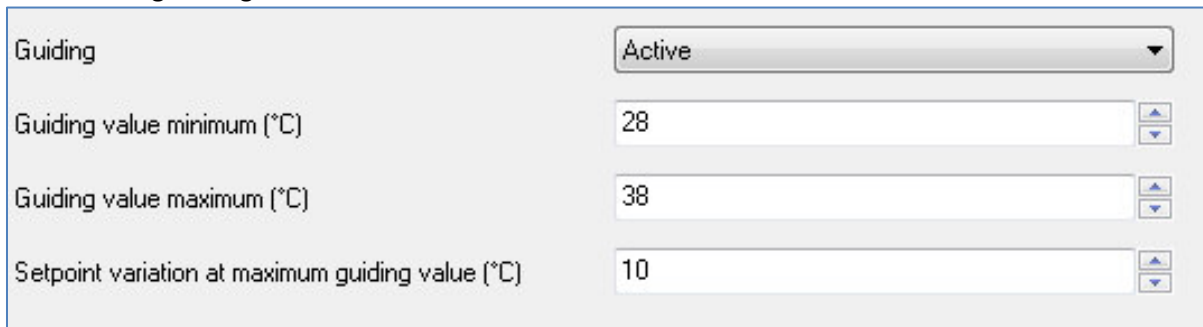

Figure 15: Guiding

The following chart shows the dynamic range for this parameter:

ETS-text	Dynamic range [default value]	comment
Guiding	<ul style="list-style-type: none"> ▪ Inactive ▪ Active 	activates/deactivates the guiding
Guiding value minimum (in °C)	-100°C – 100°C [28 °C]	minimum value of the guiding
Guiding value maximum (in °C)	-100°C – 100°C [38 °C]	maximum value of the guiding
Setpoint variation at maximum guiding value (in °C)	-100°C – 100°C [10 °C]	Setpoint offset at achievement of the maximum guiding value

Table 30: Guiding

The parameter guiding causes a linear reposition of the control value in dependence of a guiding value, which is measured by an external sensor. With appropriated parameterization a continuous increment or decrement of the control value can be caused.

For adjusting how the guiding shall impact to the control value, three settings are necessary: Guiding value minimum (w_{min}), guiding value maximum (w_{max}), and setpoint variation at maximum guiding value (ΔX).

The settings for the guiding value maximum (w_{max}) and minimum (w_{min}) describe the range of temperature in which the guiding starts and ends having impact to the setpoint. The real setpoint offset indicates the following formula:

$$\Delta X = \Delta X_{max} * [(w - w_{min}) / (w_{max} - w_{min})]$$

If the guiding shall cause an increment of the setpoint, you have to adjust a positive value for the setting "Setpoint variation at maximum guiding value". If you wish a decrement of the setpoint, you have to choose negative value for the setting "Setpoint variation at maximum guiding value".

The variation of the setpoint ΔX is added to the basic comfort setpoint.

A measured temperature value for the guiding above the adjusted maximum value or below the adjusted minimum value has no effect to the setpoint.

So when the value is between the adjusted guiding values (w_{max} & w_{min}) the setpoint is increased or decreased.

The following diagrams shall illustrate the connection between guiding and setpoint:
(Xsetpoint=new setpoint; Xbasic=basic comfort setpoint)

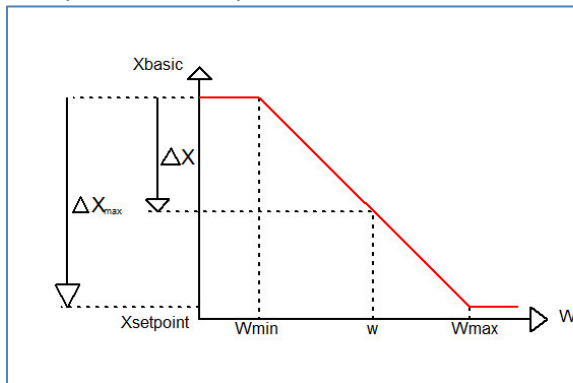

Figure 16: Example Guiding decrement

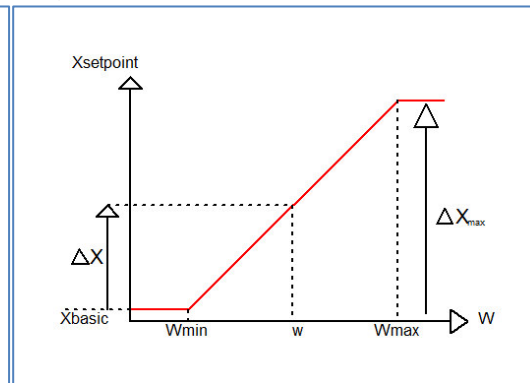

Figure 17: Example Guiding increment

The communication object for the guiding value must be connected to the external measured temperature. Through this object, the guiding becomes the reference value for the guiding process.

The following chart shows the relevant communication objects:

Number	Name	Length	Usage
20	Guiding value	2 Byte	Receiving of the reference temperature for the guiding

Table 31: Communication object guiding

Example for the usage:

For the temperature regulation of a room, the setpoint (22°C) shall be increased in a way that at a measured outside temperature range of 28°C to 38°C, the difference of the temperature outside and inside is never more than 6K.

The following settings must be done at the controller:

Basics Comfort setpoint: 22°C

Guiding: active

Guiding value minimum: 28 °C

Guiding value maximum: 38°C

Setpoint variation at maximum guiding value: 10°C

If the temperature outside increase to value of 32°C now, the setpoint will be increased by the following value:

$$\Delta X = 10^{\circ}\text{C} * [(32^{\circ}\text{C}-28^{\circ}\text{C})/(38^{\circ}\text{C}-28^{\circ}\text{C})] = 4^{\circ}\text{C}$$

So we would have a new setpoint of 22°C+4°C = 26°C.

If the outside temperature reaches the adjusted maximum of 38°C, the setpoint will be 32°C and behave this value even if the temperature would continue to rise.

4.4.7 Dead zone

The following settings are available at the ETS-Software:

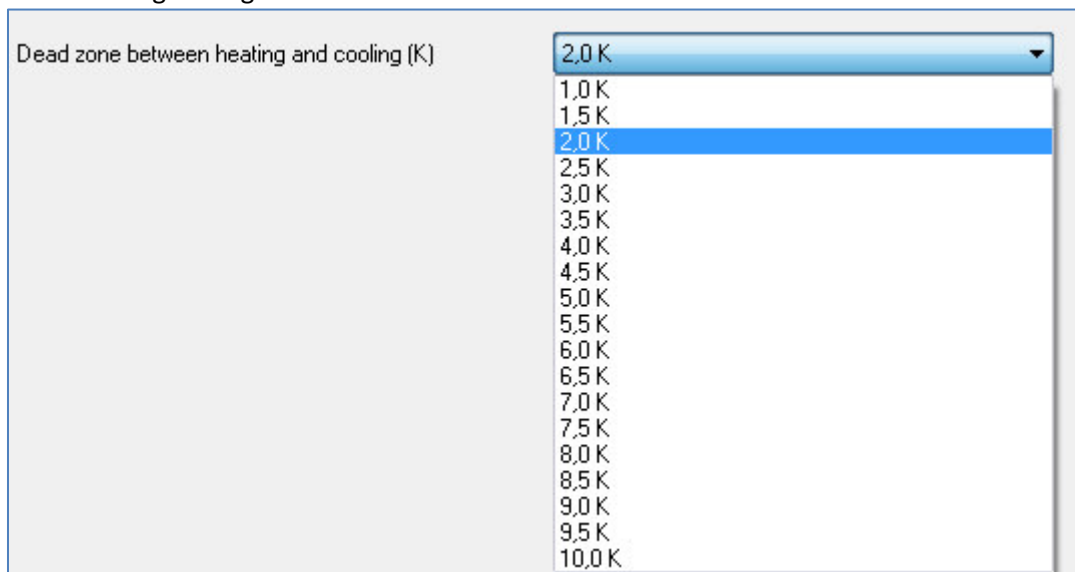

Figure 18: Dead zone

The following chart shows the dynamic range for this parameter:

ETS-text	Dynamic range [default value]	comment
Dead zone between heating and cooling (K)	1,0K – 10,0K [2,0K]	Dynamic range for the dead zone (Range at which the controller does not activate cooling or heating)

Table 32: Dead zone

The settings for the dead zone are only available, when the controller type (have a look at 4.4.1 controller type) was set as heating and cooling. Now the dead zone can be parameterized. The dead zone describes the range at which the controller neither heats nor cools. So the controller sends no value to the control value, when he is in the dead zone. At the setting for the dead zone, it is to note, that a value which was chosen too small causes many switches between heating and cooling. Whereas, a too big chosen value causes a wide range of the current room temperature. When the controller is set as heating and cooling, the basic comfort setpoint is always the setpoint for heating. The setpoint for the cooling is given by the summation of basic comfort setpoint and dead zone. So, when the basic comfort setpoint is set to 21°C and the dead zone is set to 3K, the setpoint for heating is 21°C and the setpoint for cooling is 24°C.

The dependent setpoints for heating and cooling, so the setpoints for the operating modes standby and night, can be parameterized individually at the controller type heating and cooling. So you can set different values for the night and standby reduction/increase at heating and cooling. These setpoints are calculated in dependence to the basic comfort setpoints.

The setpoints for the frost and heat protection are individually from the dead zone and the other setpoints.

The following illustration shows the correlations between dead zone and the setpoints for the single operating modes.

The following settings are made for this example:

Basic comfort setpoint: 21°C

Dead zone between heating and cooling: 3K

Increase and Reduction standby: 2K

Increase and Reduction night: 4K

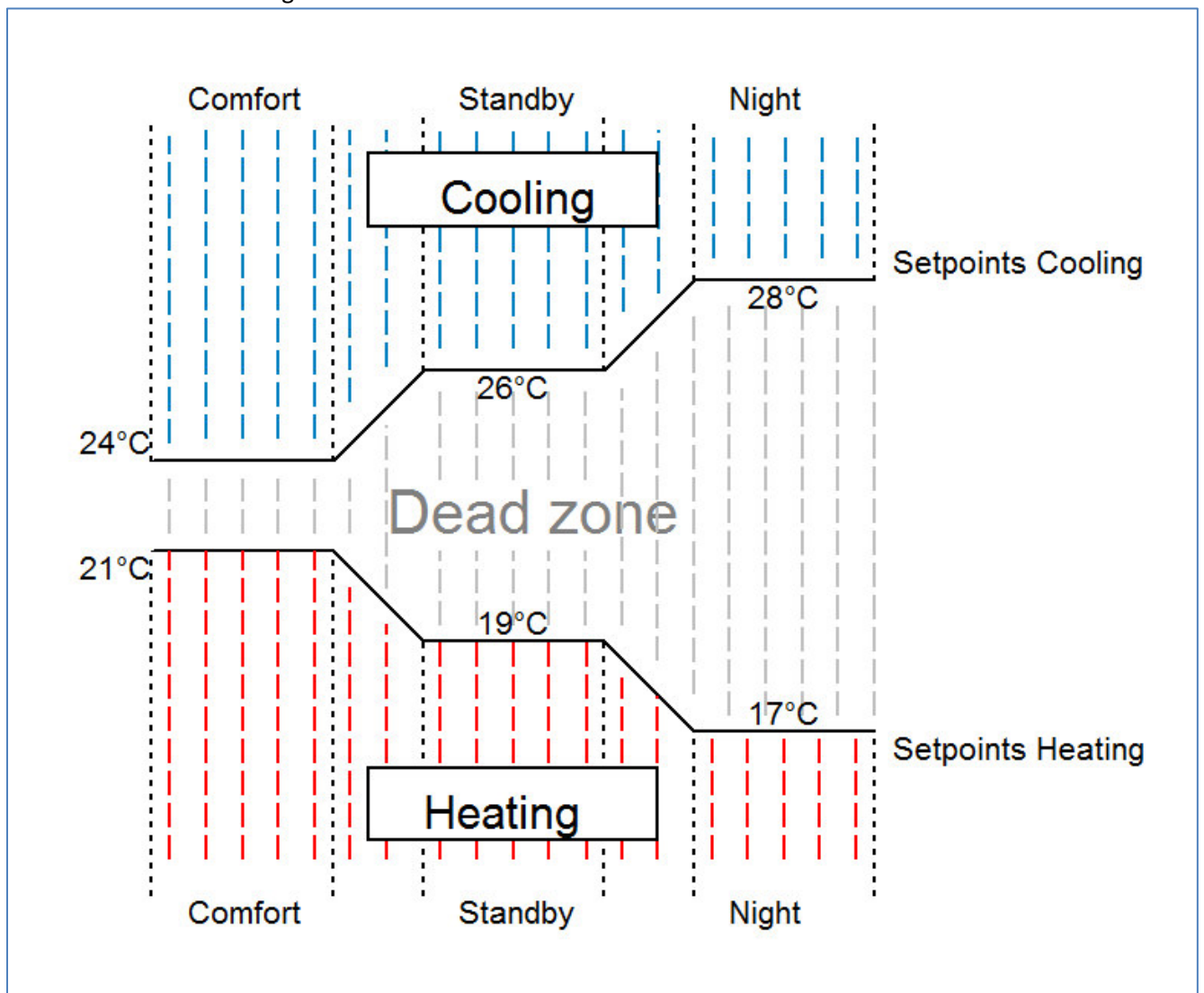

Figure 19: Example dead zone

4.5 Controller settings

4.5.1 Control value

The following settings are available at the ETS-Software:

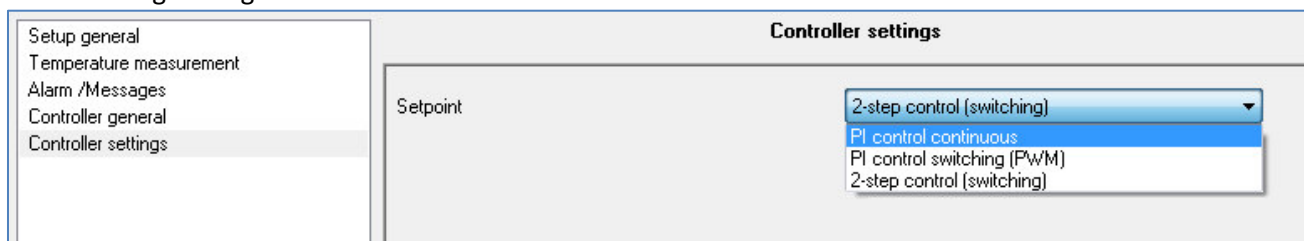

Figure 20: Control value

The following chart shows the dynamic range for this parameter:

ETS-text	Dynamic range [default value]	comment
Control value	<ul style="list-style-type: none"> ▪ PI control continuous ▪ PI control switching (PWM) ▪ 2-step control (switching) 	The control variable defines the used control method.

Table 33: Control value

The controller contains of three different controlling methods, which control the control value. Further parameterization options are dependent to the adjusted control method. The following controller can be chosen:

- PI control continuous [4.5.2 PI control continuous]
- PI control switching (PWM) [4.5.3 PI control switching (PWM)]
- 2-step control (switching) [4.5.4 2-step control (switching)]

The following chart shows the relevant communication objects:

Number	Name	Length	Usage
8	Control value heating	1 Byte/ 1 Bit	controlling of the actuator for heating
8	Control value heating/cooling	1 Byte/ 1 Bit	controlling of the combined actuator for heating and cooling
10	Control value cooling	1 Byte/ 1 Bit	controlling of the actuator for cooling

Table 34: Communication objects control value

According to the adjusted controller type (4.4.1), the control value controls a heating and/or a cooling process. If the control value is chosen as PI control continuous, the communication objects will have the size of 1 Byte, because the object can assume several states. If the control value is chosen as PI control switching or 2-step control, the communication object will have the size of 1 Bit, because the communication object can only assume the states on or off.

4.5.2 PI control continuous

The following settings are available at the ETS-Software (here for controller type heating):

Controller settings	
Setpoint	PI control continuous
Direction of controller	normal
Max value of control value	100%
Heating system	Warm water heating (5 K/150 min.)
Use additional level	No

Figure 21: PI control continuous

The following chart shows the dynamic range for this parameter:

ETS-text	Dynamic range [default value]	comment
Direction of controller	<ul style="list-style-type: none"> ▪ normal ▪ inverted 	indicates the controlling behavior at rising temperature (4.5.5)
Max value of control value	100%; 90%; 80%; 75%; 70%; 60%; 50%; 40%; 30%; 25%; 20%; 10%; 0% [100%]	indicates the output power at maximum amount
Heating system	<ul style="list-style-type: none"> ▪ Warm water heating (5K/150 min) ▪ Underfloor heating (5K/240 min) ▪ Split Unit (4K/90min) ▪ Adjustment via control parameter 	Adjustment of the used heating system Individual parameterization available by "Adjustment via control parameter"
Cooling system	<ul style="list-style-type: none"> ▪ Split Unit (4K/90min) ▪ Cooling ceiling (5K/240 min) ▪ Adjustment via control parameter 	Adjustment of the used cooling system Individual parameterization available by "Adjustment via control parameter"
Proportional range (K)	1K-8K [2K]	By choosing heating/cooling system as "Adjustment via control parameter", the proportional range can be parameterized freely
Reset time (min)	15min – 210 min [150 min]	By choosing heating/cooling system as "Adjustment via control parameter", the reset time can be parameterized freely
Send control value cyclic	Disable, 1 min, 2min, 3min, 4 min, 5min, 10min, 15min, 20min, 30min, 40min, 50min, 60min [Disable]	Activation of cyclic sending of the control value with adjustment of the cyclic time
Use additional level	<ul style="list-style-type: none"> ▪ No ▪ Yes 	Activation of an additional level available, only for heating (4.5.6)

Table 35: PI control continuous

The PI control continuous is a continuous controlling with proportional amount, the Proportional range, and an integral amount, the reset time. The size of the proportional range is indicated in K, whereas the I-amount is indicated in minutes.

The control value is controlled in steps from 0% to the adjusted maximum (have a look at 4.5.2.1 Max value of control value) for the PI-control. A big deviation causes at normal direction, a big control value to eliminate the deviation as fast as possible.

4.5.2.1 Max value of control value

By the setting “Max value of control value” can be adjusted which maximum value the control value can assume. To prevent switching processes at large control values, a maximum can be defined by the setting “Max value of control value”. So the control value cannot exceed this value.

4.5.2.2 Heating/ cooling system

The control parameter (P-amount and I-amount) are adjusted by the setting for the used heating/ cooling system. You can use preset values, which fit to determined heating or cooling systems, or parameterize the proportional range and the reset time freely. The preset values for the corresponding heating or cooling system are based on empirical values and lead often to good controlling results.

By choosing “Adjustment via control parameter”, the proportional range and the reset time can be parameterized freely. This setting requires a good knowledge in the field of control technology.

4.5.2.3 Proportional range

The proportional range describes the P-amount of the controlling. The P-amount produces a proportional increment to the deviation of the control value.

A small proportional range causes a short recovery time of the deviation. The controller reacts thereby almost immediately and sets the control value already at a small deviation almost to the maximum value (=100%). If the proportional range is chosen too small, the system will swing across.

A proportional range of 4K means a control deviation of 4°C causes a control value of 100%. So a control deviation of 1°C will cause a control value of 25%.

The following setting rules can be defined:

- **small proportional range:** swing across possible at change of setpoint; usage at fast systems; small recovery times
- **big proportional range:** almost no danger of swing across; long recovery times, usage at slow systems which need huge amplifications (big heating power etc.)

4.5.2.4 Reset time

The reset time describes the I-amount of the controlling. The I-amount of a controlling causes an integral convergence of the actual value to the setpoint. A short reset time indicates a strong I-amount.

A short reset time causes that the control value approaches fast to the control value, which is set by the proportional range. A big reset time causes a slow approach to this value.

To note is, that a reset time, which is adjusted too small, can cause across swinging. In principle you can say each carrier the system, each bigger the reset time.

The following setting rules can be defined:

- **small reset time:** fast regulating of deviations; usage at fast systems and at places with changing environmental conditions (disturbance variables like draft); danger of swinging across
- **big reset time:** slow regulating of deviations; almost no danger for swinging across; usage at slow systems as underfloor heating

4.6.2.5 Send control value cyclic

The parameter "Send control value cyclic" causes a cyclic sending of the actual control value. The time shifts between two values can be also parameterized.

4.5.3 PI control switching (PWM)

The following settings are available at the ETS-Software (here for controller type heating):

Controller settings	
Setpoint	PI control switching (PWM) ▼
Direction of controller	normal ▼
Max value of control value	100% ▼
Heating system	Warm water heating (5 K./150 min.) ▼
PWM cycletime (min)	10 min ▼
Use additional level	No ▼

Figure 22: PI control switching (PWM)

The PI control switching is a development of the PI control continuous. All settings of the continuous control are also available at the PI control switching. Additional a PWM cycletime can be adjusted (4.5.3.1 PWM cycletime).

The following chart shows the dynamic range for this parameter:

ETS-text	Dynamic range [default value]	comment
Direction of controller	<ul style="list-style-type: none"> ▪ normal ▪ inverted 	indicates the controlling behavior at rising temperature (4.5.5)
Max value of control value	100%; 90%; 80%; 75%; 70%; 60%; 50%; 40%; 30%; 25%; 20%; 10%; 0% [100%]	indicates the output power at maximum amount
Heating system	<ul style="list-style-type: none"> ▪ Warm water heating (5K/150 min) ▪ Underfloor heating (5K/240 min) ▪ Split Unit (4K/90min) ▪ Adjustment via control parameter 	Adjustment of the used heating system Individual parameterization available by "Adjustment via control parameter"

Cooling system	<ul style="list-style-type: none"> ▪ Split Unit (4K/90min) ▪ Cooling ceiling (5K/240 min) ▪ Adjustment via control parameter 	Adjustment of the used cooling system Individual parameterization available by "Adjustment via control parameter"
Proportional range (K)	1K-8K [2K]	By choosing heating/cooling system as "Adjustment via control parameter", the proportional range can be parameterized freely
Reset time (min)	15min – 210 min [150 min]	By choosing heating/cooling system as "Adjustment via control parameter", the reset time can be parameterized freely
Send control value cyclic	Disable, 1 min, 2min, 3min, 4 min, 5min, 10min, 15min, 20min, 30min, 40min, 50min, 60min [Disable]	Activation of cyclic sending of the control value with adjustment of the cyclic time
Use additional level	<ul style="list-style-type: none"> ▪ No ▪ Yes 	Activation of an additional level available, only for heating (4.5.6)
PWM cycletime (min)	5min, 10min, 15min, 20min, 25min, 30min [10min]	describes the whole time off an on-pulse and an off-pulse

Table 36: PI control switching (PWM)

At the pulse width modulation, the controller switches the control value according to the calculated value of the continuous control on and off. Thereby the control watches also the adjusted cycletime. So the control value is converted to a pulse width modulation with only the two conditions "0" and "1".

4.5.3.1 PWM cycletime

The cycletime, „PWM cycletime“, serves the controlling for calculating the length of the on-pulse and the off-pulse. This calculation occurs at the base of the calculated continuous value in percent. One PWM cycle contains the time, which elapses from one switching on point to the other.

Example: If a control value of 75% is calculated and a cycletime of 10min is adjusted, the control value will be switched on for 7,5min and switched off for 2,5min.

In principle you can say each carrier the system, each bigger the cycletime.

4.5.4 2-step control (switching)

The following settings are available at the ETS-Software (here for controller type heating):

Controller settings

Setpoint	2-step control (switching) ▼
Direction of controller	normal ▼
Hysteresis (K)	2,0 K ▼
Use additional level	No ▼

Figure 23: 2-step control (switching)

The following chart shows the dynamic range for this parameter:

ETS-text	Dynamic range [default value]	comment
Direction of controller	<ul style="list-style-type: none"> ▪ normal ▪ inverted 	indicates the controlling behavior at rising temperature (4.5.5)
Hysteresis	0,5K – 5,0K [2,0K]	Setting for the switching off point and the switching on point
Use additional level	<ul style="list-style-type: none"> ▪ No ▪ Yes 	Activation of an additional level possible, only for heating (4.5.6)

Table 37: 2-step control (switching)

The 2-step control is the easiest way of controlling. The controller switches the control value only on and off.

The controller switches the control value (for example at heating) on, when the measured temperature falls below a certain temperature. By exceeding a certain temperature, the control value will be switched off again. The points for switching on and off depend to the current adjusted setpoint and the adjusted hysteresis.

The 2-step control is used in situations, where the control value can only have two conditions and the controlled temperature can alternate a bit more.

4.5.4.1 Hysteresis

The setting of the hysteresis is used for calculating the points of switching on and off. This occurs under consideration of the current adjusted setpoint.

Example: The controller is adjusted as heating with and a basic comfort setpoint of 21°C and a hysteresis of 2K. So the controller switches the control value, at the mode comfort, on at 20°C and off at 22°C.

To note is that a big hysteresis generates big differences of the room temperature. A small hysteresis can generate an almost permanent switching process, because the points for switching on and off are very close to each other. This can generate a fast consumption of the control value.

4.5.5 Direction of controller

The following settings are available at the ETS-Software:

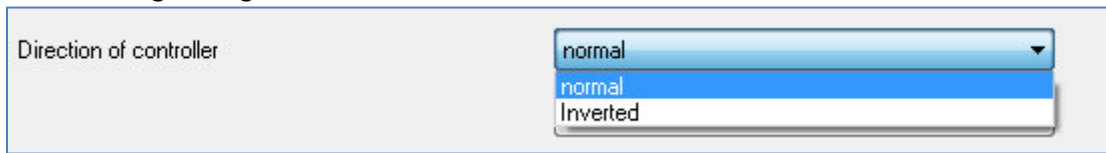

Figure 24: Direction of controller

The direction of the controller describes the behavior of the control value by a changing of the control difference at rising temperature. The control value can react normal or inverted to a rising temperature. The direction of the controller can be adjusted for all control values (PI-control continuous, PI-control switching and 2-Step control).

An inverted control value is for adaption to normally opened valves at the 2-Step control and at the PI-control switching.

An inverted control value means for the single control values, by controller type heating, the following adjustments

- PI-control continuous
The control value falls at raising regular difference and rises at falling regular difference.
- PI-control switching
The ratio between duration of switching on to the whole PWM cycletime raise by falling temperature and falls by raising temperature.
- 2-Step control
The controller switches on at the normal point for switching off and switches off at the normal point for switching on.

4.5.6 Additional level

The following settings are available at the ETS-Software:

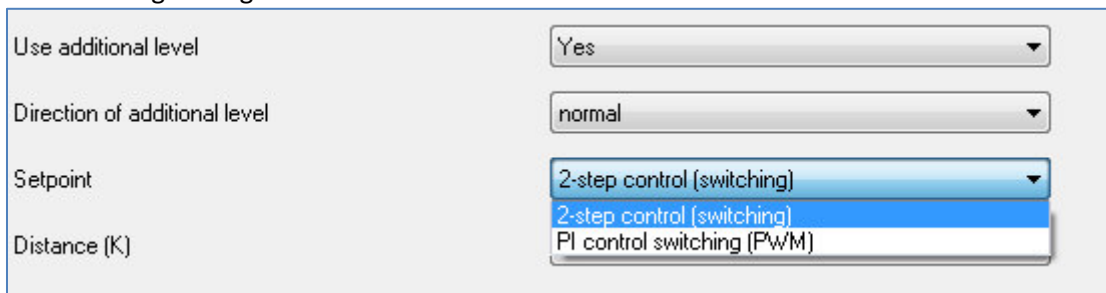

Figure 25: Additional level

The dynamic range for an additional level is shown at the following chart (the setting options are shown, when an additional level is activated):

ETS-text	Dynamic range [default value]	comment
Direction of controller	<ul style="list-style-type: none"> ▪ normal ▪ inverted 	indicates the controlling behavior at rising temperature (4.5.5)
Control value	<ul style="list-style-type: none"> ▪ 2-Step control (switching) ▪ PI control switching (PWM) 	Setting of the used control value
Distance (in K)	1,0K – 10,0K [2,0K]	Distance between the setpoints of the normal controlling and the setpoint for the additional level

Table 38: Additional level

An additional level can only be chosen for heating. The direction of the controller can be chosen for the additional level, too. The control value can be chosen as PI-control switching (PWM) or 2-Step control. So the communication object for the additional level has always the size of 1 Bit.

The distance in K describes the setpoint of the additional level. The adjusted distance is deducted from the setpoint of the basic level; the resulting value is the setpoint for the additional level.

Example: The controller has the operating mode comfort, with the basic comfort setpoint of 21°C. The distance is adjusted as 2,0K. So the setpoint for the additional level is 21°C-2,0K=19,0°C.

An additional level can be used at carry systems to reduce the warm up time. For example can a radiator be used as additional level for reducing the war up time of an underfloor heating.

The following chart shows the relevant communication object:

Number	Name	Length	Usage
9	Control value additional heating	1 Bit	control value for the additional level

Table 39: Communication object additional level

The following illustration shows the combination of the basic level and the additional level:

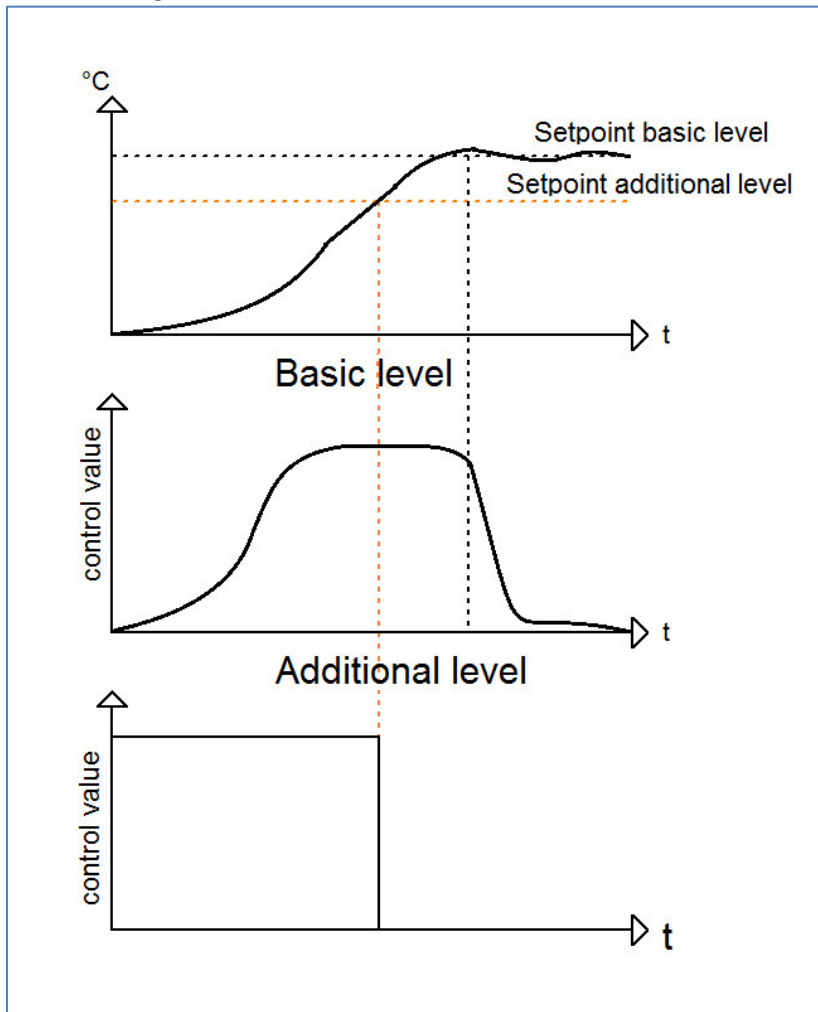

Figure 26: Combination of basic and additional level

4.5.7 Additional settings for heating and cooling

The following settings are available at the ETS-Software:

Controller settings

System	4 Pipe system ▼
Heating cooling switch over	automatically ▼

Figure 27: Heating & Cooling

The following chart shows the dynamic range, when the controller type is adjusted as heating and cooling:

ETS-text	Dynamic range [default value]	comment
System	<ul style="list-style-type: none"> ▪ 2 Pipe system ▪ 4 Pipe system 	Setting for combined or divided heating and cooling circuits
Heating/cooling switch over	<ul style="list-style-type: none"> ▪ automatically ▪ via object 	Selection between manual and automatic switch over

Table 40: Heating & Cooling

When the controller type (4.4.1 Controller type) is chosen as heating and cooling, the upper shown settings are available.

By the setting for the system, the used system can be chosen. When a combined heating and cooling system is used, the setting 2 Pipe system must be chosen. When a divided system for heating and cooling is used, the setting 4 Pipe system must be chosen.

Furthermore it is possible to choose between an automatic and a manual switch over.

4.5.7.1 - 2 Pipe system

At a common pipe system for heating and cooling, only one communication object for the control value is available. Before changing between heating and cooling, a switchover must occur. The control value can also have only one controller (PI-continuous, PI-switching, 2-Step control). Also the direction must be identical for heating and cooling. But the parameter for the heating and cooling process can be defined individually (as described from 4.5.2 to 4.5.4).

The following illustration shows the setting option for a 2 Pipe system:

Controller settings	
System	2 Pipe system ▼
Heating cooling switch over	automatically ▼
Setpoint	PI control continuous ▼
Direction of controller	normal ▼
Settings heating	
Max value of control value	100% ▼
Heating system	Warm water heating (5 K/150 min.) ▼
Use additional level	No ▼
Settings cooling	
Max value of control value	100% ▼
Cooling system	Split unit (4 K / 90 min.) ▼

Figure 28: 2 Pipe system

4.5.7.2 - 4 Pipe system

When a divided pipe system is used, both operations can be parameterized individually. Consequently two communication objects for the control value exist. So it is possible, to control the heating process e.g. via a PI-control continuous and the cooling process e.g. via a 2-step control, because both processes are controlled by different devices. So for every of the both processes are the settings available, which are described from “4.5 controller settings”.

The following illustration shows the setting options for a 4 Pipe system:

Controller settings	
System	4 Pipe system
Heating cooling switch over	automatically
Settings heating	
Setpoint	2-step control (switching)
Direction of controller	normal
Hysteresis (K)	2,0 K
Use additional level	No
Settings cooling	
Setpoint	PI control continuous
Direction of controller	normal
Max value of control value	100%
Cooling system	Split unit (4 K / 90 min.)

Figure 29: 4 Pipe system

4.5.7.3 Switchover heating and cooling

By the setting “heating/cooling switch over” it is possible to adjust whether the controller shall switch automatically or via communication object. At the automatic switchover, the controller evaluates the setpoints and knows because of the adjusted setpoints in which mode the controller is at the moment. When the controller heated before, the controller switches over when the measured temperature rises over the adjusted setpoint for cooling. As long as the controller is at the dead zone between heating and cooling, the heating process remains set, but does not heat as long as the temperature is above the adjusted setpoint for heating.

By choosing the switchover via object, an additional communication object is shown. By this object the switchover can be done. The controller stays as long at the adjusted operating mode until it becomes a signal via the according communication object. As long as the controller is at the heating mode only the setpoint for the heating is watched, also if the controller is, according to its setpoints, already at the cooling mode. A start of the cooling mode is also only possible, when the controller becomes a signal via the communication object.

A “0” switches the heating process on and a “1” switches the cooling process on.

The following chart shows the relevant communication object:

Number	Name	Length	Usage
19	Heating/Cooling switchover	1 Bit	Switchover between heating and cooling 1=heating; 0=cooling

Table 41: Communication object heating and cooling

5 Index

5.1 Register of Illustrations

Figure 1: Exemplary circuit diagram.....	5
Figure 2: SCN-RT1UP.01 Figure 3: SCN-RT1APE.01 Figure 4: SCN-RT1UPD.01.....	5
Figure 5: General settings.....	11
Figure 6: Temperature measurement.....	12
Figure 7: Alarm/Messages.....	14
Figure 8: Setting controller type.....	16
Figure 9: Operating modes & setpoints.....	17
Figure 10: Priority of the operating modes.....	19
Figure 11: Operating mode after reset.....	22
Figure 12: Setpoint offset.....	23
Figure 13: Blocking objects.....	25
Figure 14: Heating/Cooling request objects.....	26
Figure 15: Guiding.....	27
Figure 16: Example Guiding decrement Figure 17: Example Guiding increment.....	28
Figure 18: Dead zone.....	29
Figure 19: Example dead zone.....	30
Figure 20: Control value.....	31
Figure 21: PI control continuous.....	32
Figure 22: PI control switching (PWM).....	35
Figure 23: 2-step control (switching).....	37
Figure 24: Direction of controller.....	39
Figure 25: Additional level.....	39
Figure 26: Combination of basic and additional level.....	41
Figure 27: Heating & Cooling.....	42
Figure 28: 2 Pipe system.....	43
Figure 29: 4 Pipe system.....	44

5.2 List of tables

Table 1: Functional overview	8
Table 2: Communication objects – default settings.....	10
Table 3: General settings.....	11
Table 4: Parameter Temperature measurement	12
Table 5: Communication object temperature value	13
Table 6: Communication objects Min/Max values.....	13
Table 7: Communication objects external sensor	13
Table 8: Parameter Alarm/Messages	14
Table 9: Communication objects alarm.....	15
Table 10: Communication objects messages	15
Table 11: Setting controller type.....	16
Table 12: Operating modes & setpoints.....	17
Table 13: Communication object operating mode comfort.....	18
Table 14: Communication object operating mode night	18
Table 15: Communication object operating mode frost/heat protection	18
Table 16: Priority of the operating modes	19
Table 17: Example switchover of the operating modes via 1 Bit.....	19
Table 18: Hex-Values for operating modes (from Version 1.2).....	20
Table 19: Example operating mode switchover via 1 Byte (from Version 1.2).....	20
Table 20: Hex-Values DPT HVAC Status (from Version 1.2)	20
Table 21: Hex-Values DPT RHCC Status (from Version 1.2).....	21
Table 22: Communication objects for the operating mode switchover	21
Table 23: Operating mode after reset.....	22
Table 24: Setpoint offset	23
Table 25: Communication objects setpoint offset	24
Table 26: Blocking objects	25
Table 27: Communication objects blocking objects.....	25
Table 28: Heating/Cooling request objects.....	26
Table 29: Communication objects heating/cooling request	26
Table 30: Guiding.....	27
Table 31: Communication object guiding.....	28
Table 32: Dead zone	29
Table 33: Control value	31
Table 34: Communication objects control value.....	31
Table 35: PI control continuous.....	32
Table 36: PI control switching (PWM)	36
Table 37: 2-step control (switching).....	37
Table 38: Additional level	40
Table 39: Communication object additional level.....	40
Table 40: Heating & Cooling	42
Table 41: Communication object heating and cooling.....	45

6 Attachment

6.1 Statutory requirements

The above-described devices must not be used with devices, which serve directly or indirectly the purpose of human, health- or lifesaving. Further the devices must not be used if their usage can occur danger for humans, animals or material assets.

Do not let the packaging lying around careless, plastic foil/ -bags etc. can be a dangerous toy for kids.

6.2 Routine disposal

Do not throw the waste equipment in the household rubbish. The device contains electrical devices, which must be disposed as electronic scrap. The casing contains of recyclable synthetic material.

6.3 Assemblage



Risk for life of electrical power!

All activities on the device should only be done by an electrical specialist. The county specific regulations and the applicable EIB-directives have to be observed.

6.4 Controller

Three different controller types can be chosen for the control value. These controller types are described for the heating process by the following illustrations.

6.4.1 2-Step control

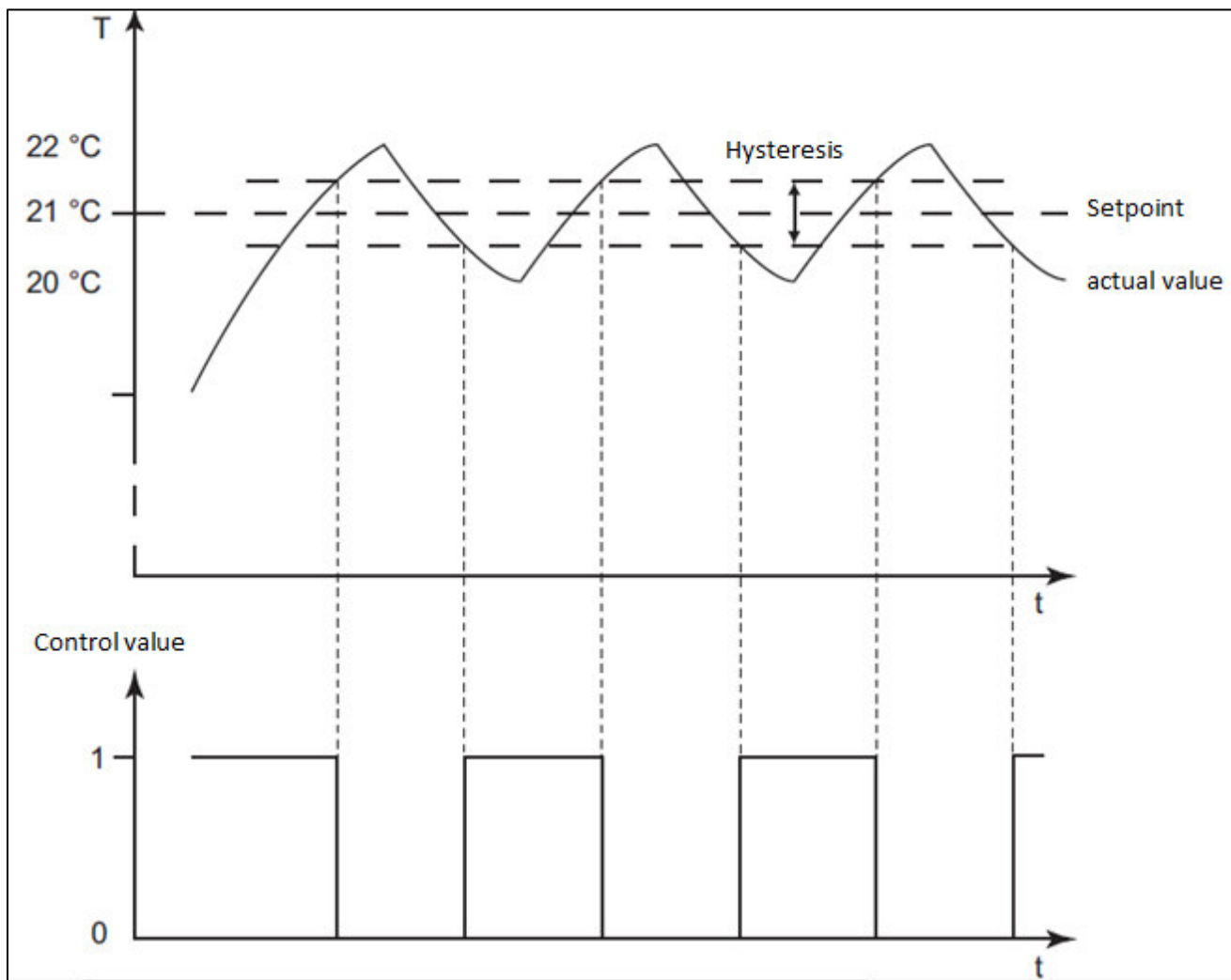

6.4.2 PI-control continuous

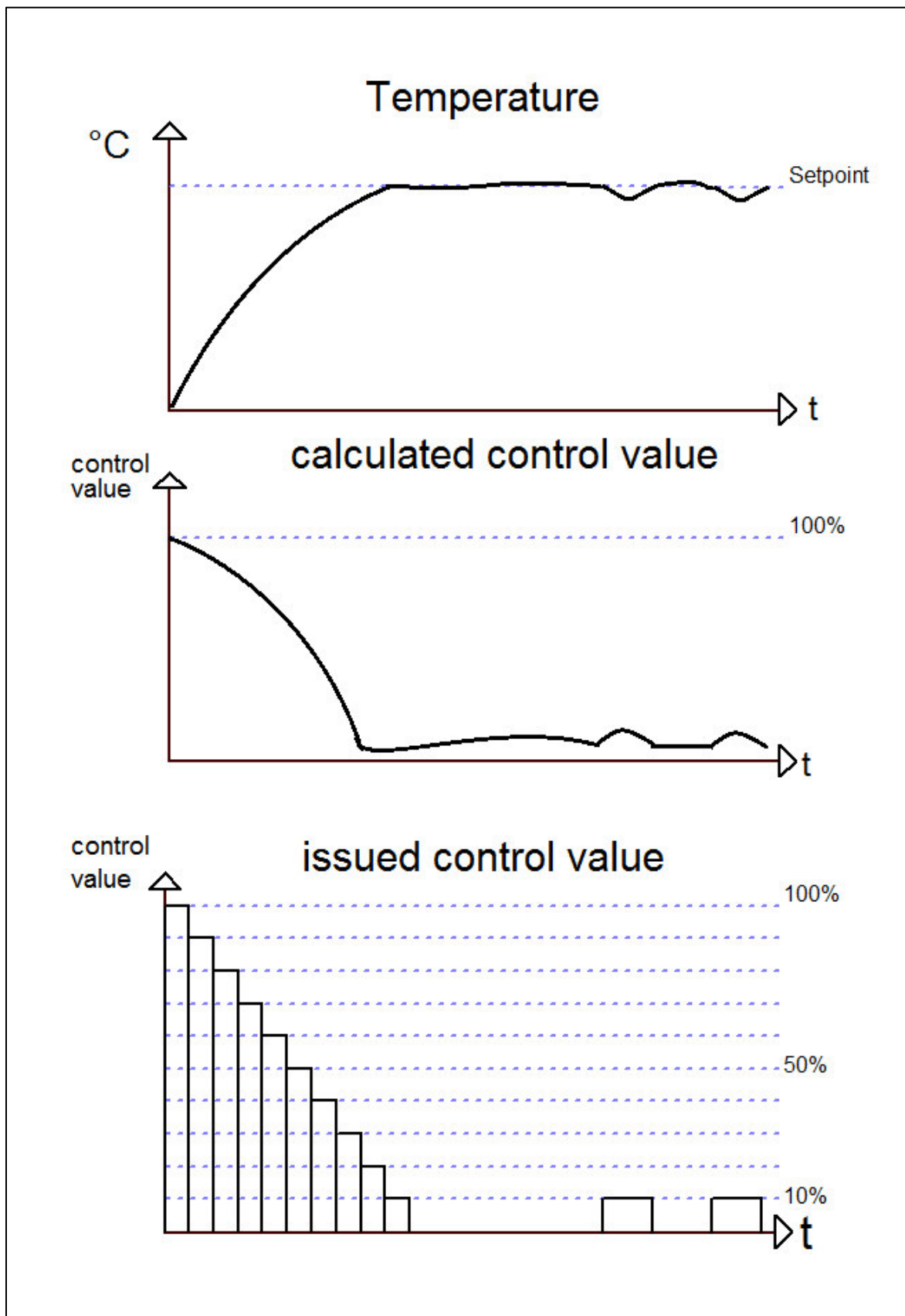

6.4.3 PI-control switching (PWM)

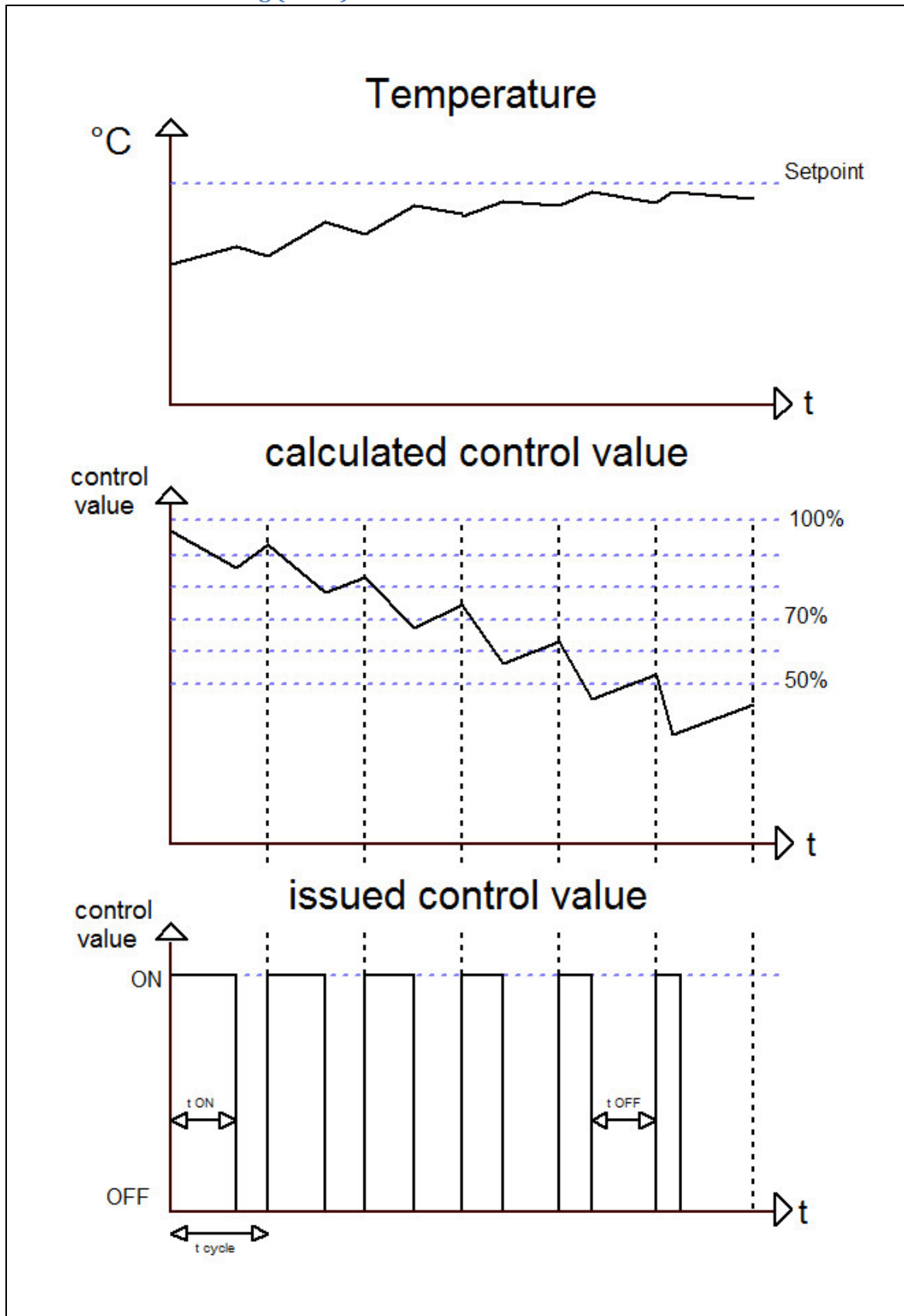

6.5 Direction of controller

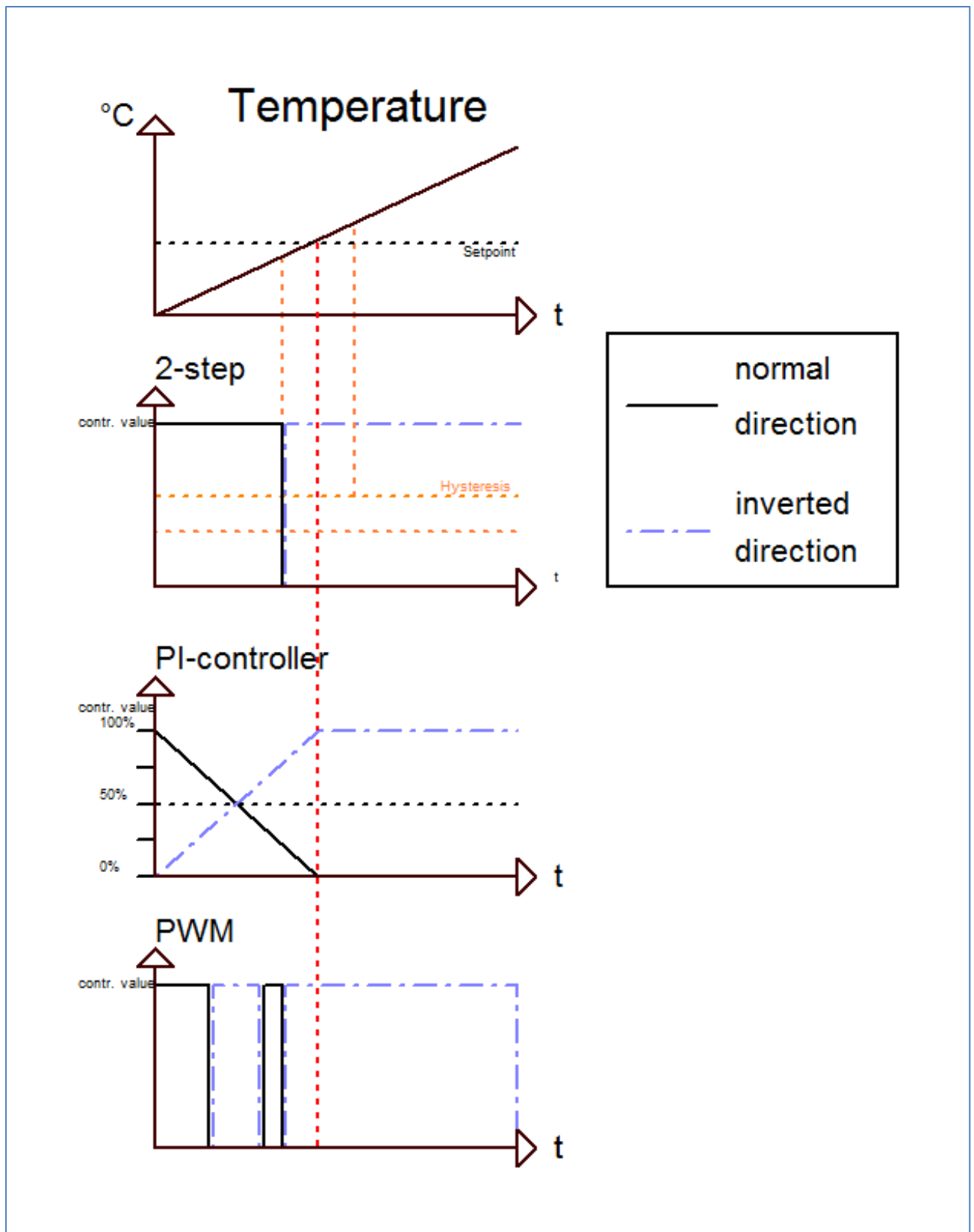

6.6 Datasheet

MDT Room Temperature Controller 1-fold, flush mounted
MDT Room Temperature Controller 1-fold, surface mounted

Version		
SCN-RT1UP.01	Room Temperature Controller 1-fold	Flush mounted, white matt finish, 55mm
SCN-TS1UP.01	Room Temperature Sensor 1-fold	Flush mounted, white matt finish, 55mm
SCN-RT1UPE.01	Room Temperature Controller 1-fach with adjustment knob	Flush mounted, white matt finish, 55mm
SCN-RT1APE.01	Room Temperature Controller 1-fach with adjustment knob	Surface mounted, white matt finish

The MDT Room Temperature Controller is used to control the indoor temperature, it has a working range from -10 to +50°C. The MDT Room Temperature Controller detects the temperature and releases telegrams in dependence on its parameterisation. The characteristic of the MDT Temperature Controller (Two-position, PI and PWM control) can be set in the ETS3/4. The MDT Room Temperature Controller stores the minimum and maximum temperature and releases an alarm telegram if the temperature differs from the programmed limit values. The temperature of the frost protection is parameterizable.

Fits 55mm systems:

- BERKER S1, B1, B3, B7 glass
- GIRA Standard 55, E2, Event, Esprit
- JUNG A500, Aplus
- MERTEN M-Smart, M-Arc, M-Plan

The MDT Room Temperature Controller is a flush mounted device for fixed installations in dry rooms, it is delivered with support ring.

For project design and commissioning of the MDT Room Temperature Controller it is recommended to use the ETS3f/ETS4 or later. Please download the application software at www.mdt.de/Downloads.html

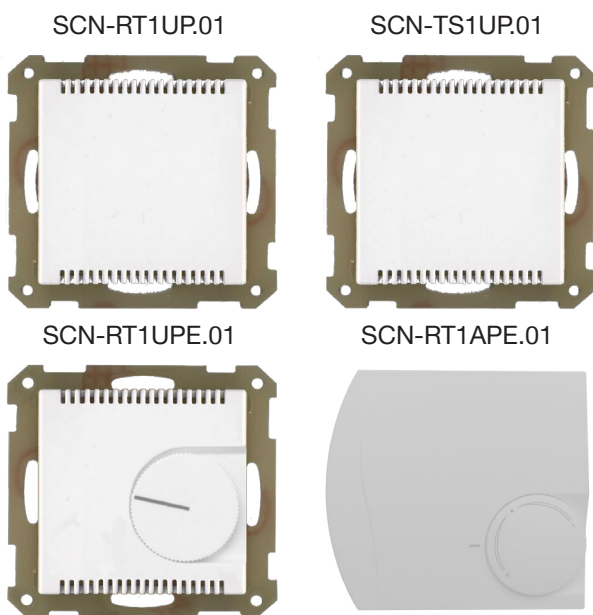

- Production in Germany, certified according to ISO 9001
- Fits all switches with 55mm rocker:
 - BERKER S1, B1, B3, B7
 - GIRA Standard 55, E2, Event, Esprit
 - JUNG A500, Aplus
 - MERTEN M-Smart, M-Arc, M-Plan
- Selectable temperature controller (PI, Two-position, PWM)
- Given value is stored at voltage failure
- Bit/Byte object to set the given value
- For indoor temperature controlling, range -10° to +50°C
- Limit values min/max, Frost protection alarm, Memory for min/max
- Desired value can be given by visualisation, e.g. MDT VisuControl
- Day-, night- and frost protection operation
- Status feedback by HVAC and RHCC status objects
- Operation mode can be set via Bit/Byte objects
- Installation with support ring (Included in delivery)
- Integrated bus coupling unit
- 3 years warranty

Technical Data	SCN-RT1UP.01	SCN-RT1UPE.01	SCN-TS1UP.01	SCN-RT1APE.01
Configuration	RTC	RTC	Temperature sensor	RTC
Number of Channels	1	1	1	1
Measurement range temperature	-10 to +50°C	-10 to +50°C	-10 to +50°C	-10 to +50°C
Permitted wire gauge				
KNX busconnection terminal	0,8mm Ø, solid core	0,8mm Ø, solid core	0,8mm Ø, solid core	0,8mm Ø, solid core
Power supply	KNX bus	KNX bus	KNX bus	KNX bus
Power consumption KNX bus typ.	< 0,25W	< 0,25W	< 0,25W	< 0,25W
Operating temperature range	-10 to +50°C	-10 to +50°C	-10 to +50°C	-10 to +50°C
Enclosure	IP 20	IP 20	IP 20	IP 20
Dimensions (W x H x D)	55mm x 55mm x 13mm	55mm x 55mm x 13mm	55mm x 55mm x 13mm	91mm x 85mm x 26mm

Exemplary circuit diagram SCN-xTxxxx.01

