

ufo lens 100w, 150w, 200w, 240w

COD. 4502, 4503, 4504, 4505, 4506, 4507, 4508

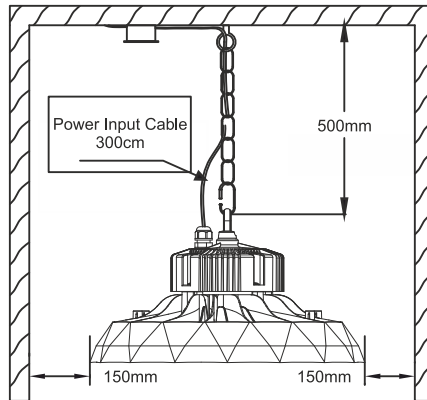
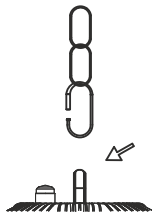
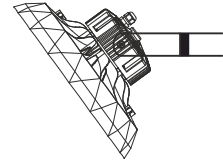
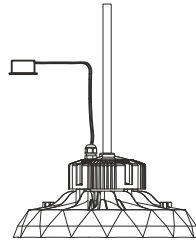
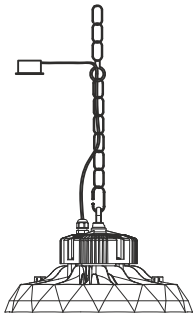

Danger!

Installation by electricians only

LED TYPE SMD

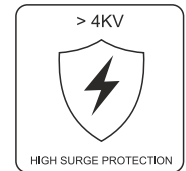

**THE EXTERNAL POWER CORD MUST BE A VDE-CERTIFIED
H05RN-F3X1.0MM2 WATERPROOF CABLE**

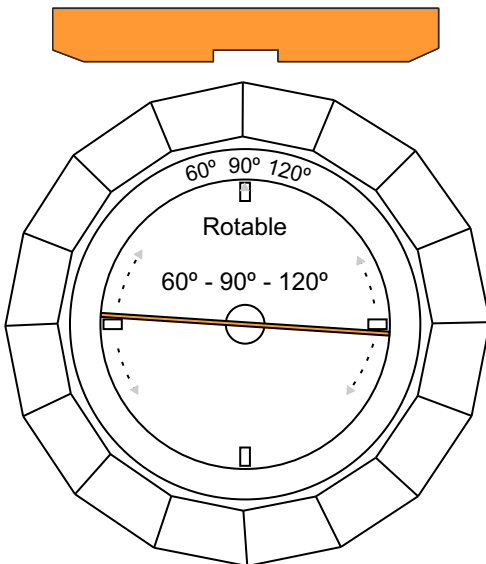

Spannungsbereich 90 ~ 305 Vac, Überspannungsschutz (OVP), Überhitzungsschutz (OTP) und Kurzschlusschutz (SCP).



Voltage range is 90~305 Vac, with over-voltage protection (OVP), over-temperature protection (OTP) and short-circuit protection (SCP).



Rango de voltaje de 90 ~ 305 Vac, protección contra sobretensión (OVP), protección contra sobretemperatura (OTP) y protección contra cortocircuitos (SCP).



Gamme de tension de 90 ~ 305 Vac, protection contre les surtensions (OVP), protection contre la surchauffe (OTP) et la protection contre courts-circuits (SCP).



Campo di tensione di 90 ~ 305 Vac, protezione da sovratensione (OVP), protezione termica (OTP) e cortocircuito (SCP).



ALUMINIUM



IP65

CE



EMC

CB

TÜV Rheinland



160lm/w



RoHS

