



B.E.G. LUXOMAT® PD4-M-2C-C

Installation and Operating Instruction for B.E.G. - Occupancy detector PD4-M-2C-C-SM/FC/FM

1. Mounting preparation

Work on the 230 V mains supply may only be carried out by qualified professionals or by instructed persons under the direction and supervision of qualified skilled electrical personnel in accordance with electrical regulations.

Disconnect supply before installing!

The device is not suited for safe disconnection of the mains supply.

When in Master/Slave mode of operation, the Master-appliance must always be installed at the location where there is least daylight.

2a. Installation LUXOMAT® PD4-M-2C-C-SM

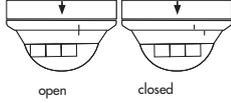

CAUTION:
For maximum sensitivity the detector, lens- and corridor-axis must match

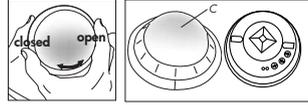

The detector must be installed on a solid and level surface. The circular cover ring must be removed prior to assembly. To do this, twist the lens anti-clockwise through approximately 5° and lift off.

Having connected up the wires in accordance with regulations, secure the detector with 2 screws. After installation replace the lens and lock (turn clockwise). Mains to be connected.

2b. Installation LUXOMAT® PD4-M-2C-C-FC

A circular opening of diameter 68 mm must first of all be produced in the ceiling

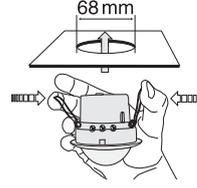

Having connected up the cables in accordance with regulations, the detector is inserted into the opening as shown in the drawing opposite and fixed into position with the assistance of the spring clip.

2c. Installation LUXOMAT® PD4-M-2C-C-FM

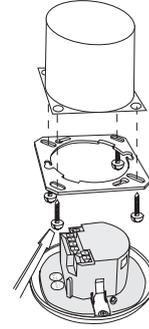

The detector can be installed in conventional inlet-sockets mounted on the ceiling. The assembly plate enclosed must be stripped off prior to installation and secured to the ceiling using 4 screws.

Having connected up the cables in accordance with regulations, the detector can be placed in position as shown in the drawing opposite and, applying a little pressure, can then be locked into position with the assistance of the spring clips.

(For connections please see pt. 2!)

3a. Hardware configuration SM

Position LED's

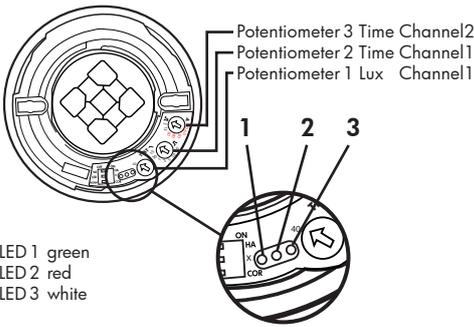

LED 1 green
LED 2 red
LED 3 white

3b. Hardware configuration FC

Position LED's and potentiometers

LED 1 green
LED 2 white
LED 3 red

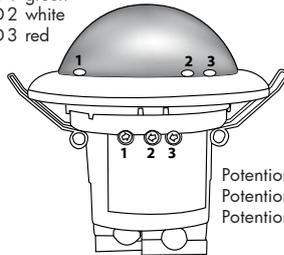

Potentiometer 1 Lux Channel1
Potentiometer 2 Time Channel1
Potentiometer 3 Time Channel2

3c. Hardware configuration FM

Position LED's and potentiometers

LED 1 green
LED 2 white
LED 3 red

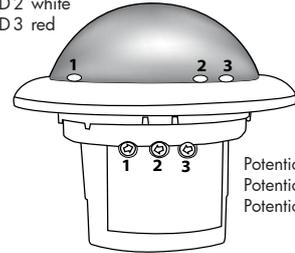

Potentiometer 1 Lux Channel1
Potentiometer 2 Time Channel1
Potentiometer 3 Time Channel2

4a. Position potentiometers DIP-Switch SM

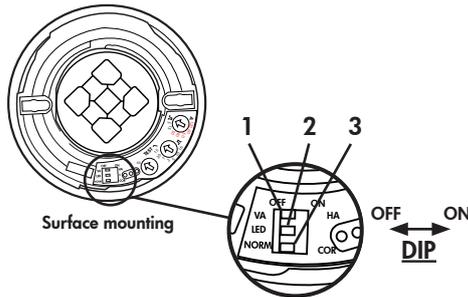

- DIP 1 Fully automatic/semi automatic mode
- DIP 2 LED ON/OFF
- DIP 3 Change between corridor mode and standard mode

The DIP switch settings are overridden using the remote control.

4b. Position DIP-Switch FC

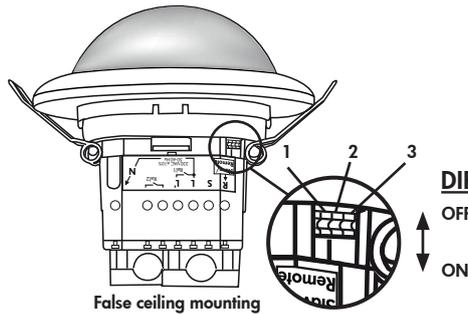

- DIP 1 Fully automatic/semi automatic mode
- DIP 2 LED ON/OFF
- DIP 3 Change between corridor mode and standard mode

The DIP switch settings are overridden using the remote control.

4c. Position DIP-Switch FM

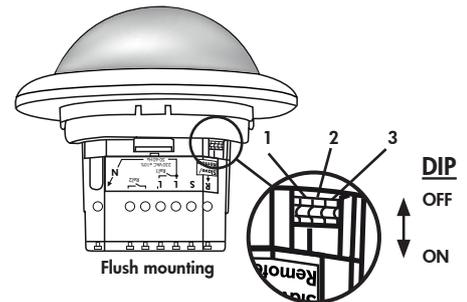

- DIP 1 Fully automatic/semi automatic mode
- DIP 2 LED ON/OFF
- DIP 3 Change between corridor mode and standard mode

The DIP switch settings are overridden using the remote control.

5. DIP switch functions

DIP-switch	ON	OFF
1	Semi automatic mode	Fully automatic mode
2	LED OFF	LED ON
3	Corridor mode	Standard mode

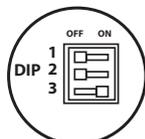

Corridor function: After deactivation by an external push button, the detector switches off and returns to automatic mode after 5 sec.

The DIP settings are enabled again by:

- Adjusting the DIP switches when closed
- Reset with test sun setting at the potentiometers
- Reset when open

6. Putting into operation / Settings

Self test cycle

After an initial 60-second self-test cycle, the LUXOMAT® PD4-M-2C-C is ready for operation.

Potentiometer 1 - Adjustment twilight-switch for channel 1 "Light"



The switch-on value for the light can be set at between 10 and 2000 Lux. Using the potentiometer, the luminance set points can be set as desired.

Symbol ☾: Night operation

Symbol ☀: Day/Night operation

Determining the current brightness

Set potentiometer 2 to the „Test“ setting. The green LED lights up permanently as soon as the value set at the potentiometer "Lux" drops below the current measured brightness..



Potentiometer 2 - Adjustment follow-up time channel 1 "Light"

Symbol TEST: Test mode, reacts on motion only. Every movement switches on the light for a period of 2 seconds, switching it off for a period of 2 seconds. The time can be set infinitely variably at between 15 sec. and 16 minutes.



Potentiometer 3 - Follow-up time for appliance-control

The time can be set infinitely variably at between 5 minutes and 120 minutes. After 15 minutes the switch-on delay is activated. This is around 5 min. If there are not detected any further movements within this period, the switch-on delay starts again.

Symbol \square : Impulse = 2,5 sec.

Symbol A: Alarm impulse = 2 sec.

Alarm impulse

In order to set off an alarm impulse, at least 3 movements within 9 sec. have to be detected.

The potentiometer settings are overridden using the remote control.

Pulse spacing PD-Slave



2 or 9 seconds can be set for the pause between 2 pulses sent to the master. The setting can be made with activated (☀) or deactivated (☾) LED indicator.

For devices with a separate slave input, 2 sec. can be set.

7. Reset and default settings

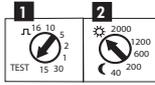

1. Default settings

If the potentiometers are in the "Test" and "Sun" position and the detector is unprogrammed, the factory program is activated: 500 lux and 10min and corridor operation mode active.

2. Reset

If both potentiometers are returned to the "Test" and "Sun" setting from any other position, a reset is executed. All values programmed with the remote control are deleted.

8. Putting into operation of the remote control IR-PD-2C (optional)

Check Battery:

Open battery compartment by pressing the plastic springs together and removing the battery-holder.

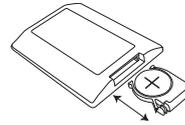

Caution: Settings with remote control supersede the settings by potentiometers.

Option: Remote control IR-PD-2C



Folie IR-PD-2C-S



IR-PD-2C - 92475



Wall bracket for remote control

An adhesive film for the surface of the IR-PD-2C-S is included with the device. If required, this can be used for any B.E.G. remote control with 27 keys.

In order to benefit from the whole range of functions of the PD4-M-2C-C, please order separately the remote control IR-PD-2C.

9. Settings by remote control IR-PD-2C

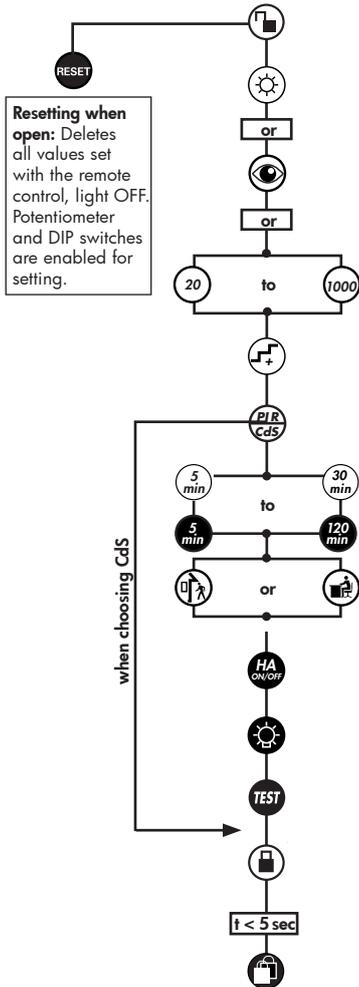

Unlocking device - Activation of the programming mode

Daytime operation, detector only activated by motion

Automatic reading in the current light value as new luminance set point

Luminance set point for channel 1
20 - 1000 Lux

Increase the current light level by
20 resp 50 Lux

Change between motion detector and photo electric switch

Follow-up time ch1 (light)/
ch 2 (HVAC) 5 - 30 min. resp.
120 min. or impulse
(switch-on delay ch 2:5 min.)

Detection sensitivity reduced or normal

Change between fully automatic
and semi automatic mode (HA)

Light ON/OFF

LED ON/OFF (by holding down the push button)

Locking device - Exit programming mode
If there is not reaction for about 3 minutes the programming mode will be deactivated.

White LED flashes

Permanent protection against sabotage

10. Key functions in closed state



Permanent protection against sabotage

This function blocks the unit permanently. This operating mode can only be activated during the period of 5 seconds (white LED flash) after pressing the "lock" button. The procedure for leaving this mode is as follows:

1. Switch off the current
2. Apply current for 31 - 59 seconds
3. Switch of the current again
4. Apply current, wait for selftest cycle
5. Open detector



Light ON/OFF during the detection of motion plus follow-up time;
Activation of the 12 h-ON/OFF-function by holding down the push button



Activation/Deactivation of the test function

After 3 minutes the test mode will be automatically closed.



Switches channel off and is immediately active again, exits all timers, interruption of light measurement



Confirmation



Changes to "open" state

11. Explanation of the remote control button functions

11a. In the initialisation period

- 12 h Light ON/OFF (party function)**
Activated by "Light" - push button
- Deactivated by "Reset" - push button (default)

- Corridor function**
Activated by "outside" - push button
- Deactivate by "inside" - push button (default)

- Forced shutdown**
Activated by "sun" - push button
- Deactivate by "moon" - push button (default)

11b. In opened state

- This push button opens the detector and the following functions can then be programmed.

Attention: The detector is closed automatically:

- after every voltage recovery
- after 3 minutes

- The state changes to "closed".
In the first 5 seconds, the white LED flashes every 0.5 seconds. During this time, sabotage protection can be activated.

The device distinguishes between 2 procedures:

- **Reading in with lighting switched on:**
The switch-on value is determined automatically.

Determining the switch-on value:

1. Press the "eye" push button
2. Switch off the light (2 seconds later)
3. Read in the brightness
4. Switch-on value = Read brightness

- **Reading in with lighting switched off:**

When the push button is pressed, the current brightness is specified as the switch-on value. The switch-off value is determined automatically.

- 20
1000
If the brightness has been modified, the switch-off threshold is recalculated.

- Each time the push button is pressed, the device increases the current switch-on value in increments of 20 lux for a current switch-on value of < 100 lux and in increments of 50 lux for a current switch-on value of > 100 lux.

- Standard sensitivity for most applications
- Reduced sensitivity for outdoor applications

- When the pulse function of channel 1 is active, a pulse of 1 sec. is generated every 9 sec. If the pulse function is activated via remote control, the pause between 2 pulses can be modified. After activating the function via the "Pulse" push button, select the desired time within 5 sec.:

$$\left(\frac{5}{\text{min}}\right) = 9 \text{ sec.}, \left(\frac{10}{\text{min}}\right) = 10 \text{ sec.}, \left(\frac{15}{\text{min}}\right) = 15 \text{ sec.}, \left(\frac{30}{\text{min}}\right) = 30 \text{ sec.}$$

- The impulse function of channel 2 depends only on motion! After each movement the HVAC channel is activated for 2.5 sec.; time delay starts afterwards for 9 sec.

- The "Test" push button can be used to set the LED ON/OFF function. To do this, hold down the push button for 3 sec.
Please note that in the open state and in test mode, the LED indicators are always ON.

Twilight switch function (CdS)

- If the CdS function is active, the detector acts as a simple twilight switch. Only the brightness can be set in this mode. Movements are no longer indicated by the red LED.

Push button acknowledgement:

Each push of a button is indicated by lamp acknowledgement and by the white LED.

"Light ON" status: OFF/ON (approx. 0.5 sec. each)
"Light OFF" status: ON/OFF (approx. 0.5 sec. each)

12. Switch-off threshold brightness

1. If the switch-on threshold has been modified by the potentiometer or remote control, the switch-off threshold stored in the EEPROM is deleted and is then recalculated on the next activation.

Determining the switch-off value

1. Switch on for 5 min. with dark and motion
2. Light OFF for 2 sec.
3. Internal calculation of the switch-off value

2. If the eye push button is pressed, the switch-off threshold is recalculated. See also Remote control → Eye section

3. Switch-off delay

If the determined switch-off threshold is exceeded during operation, the detector only switches off after a delay of approx. 15 minutes. This compensates for any brief fluctuations in the brightness.

13a. Behaviour of external push button/IR "Light"

The "Corridor" and "Light ON/OFF" functions are mutually exclusive. If both are activated, the detector performs the corridor function.

The behaviour when the push button is pressed is defined as follows:

Corridor function activated

Light ON:

Push button pressed briefly: Light OFF → Active after 5 sec.
Push button held down: Light OFF → Active after 5 sec.

Light OFF:

Push button pressed briefly: Light ON as long as motion + Lag time
Push button held down: Light ON as long as motion + Lag time

13b. Behaviour of external push button/IR "Light"

12 h Light ON/OFF activated

Light ON:

Push button pressed briefly: Light OFF → Active after 5 sec.
Push button held down: 12 h OFF

Light OFF:

Push button pressed briefly: Light ON as long as motion + Lag time
Push button held down: 12 h ON

12 h Light ON/OFF deactivated

Light ON:

Push button pressed briefly: Light OFF as long as motion + Lag time
Push button held down: Light OFF as long as motion + Lag time

Light OFF:

Push button pressed briefly: Light ON as long as motion + Lag time
Push button held down: Light ON as long as motion + Lag time

13c. Behaviour of external push button/IR "Forced shutdown"

Forced shutdown active

Light OFF:

Light OFF: Push button pressed briefly: Light ON for approx. 30 min., then forced shutdown if the set brightness is still exceeded.

14. Other functions

Activation of light for 12 h via mains interruption

1. Interrupt current
2. Apply current for 2 to 5 sec.
3. Interrupt current again
4. Apply current
5. Detector is now ON for 12 h

Exiting sabotage

1. Interrupt current
2. Apply current for 30 to 60 sec.
3. Interrupt current again
4. Apply current
5. Detector is in simple closed state

230 V AC permanently at the slave input

If 230 V AC is applied at the slave input for longer than 10 sec., the light is switched on permanently. When the 230 V is removed, the light is switched off and automatic mode is activated.

230 V AC for 1 - 3 sec. at push button connection S

If 230 V AC is applied for 1 - 3 sec. at push button connection S, this is interpreted as a slave signal at slave connection R. This ensures that the detector is compatible with previous versions.

15. Fully automatic and semi automatic mode

(see functions IR-PD-2C)

Fully automatic operation

In this operating mode, the lighting switches automatically on and off for increased comfort, depending on presence and brightness. Channel 1 switches on in the event of motion if "dark" is detected.

Semi automatic operation

In this operating condition, in order to gain increased savings, the lighting is energized only after being manually switched on. Switch-off takes place automatically or manually.

The semi automatic mode basically behaves like the fully automatic one. However, the difference is that switching-on must always be carried out manually!

As many (NO-contact) buttons as desired can be wired in parallel on the "S" button input (ON/OFF).

Triggering in semi automatic mode: If the detector switches off in semi automatic mode (lag timer elapsed), the detector is switched on again within 10 sec. by motion (despite semi-automatic mode).

16. Range of Coverage

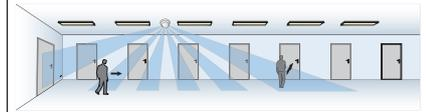
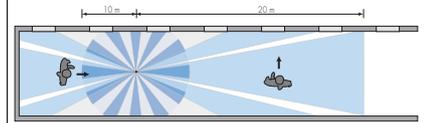
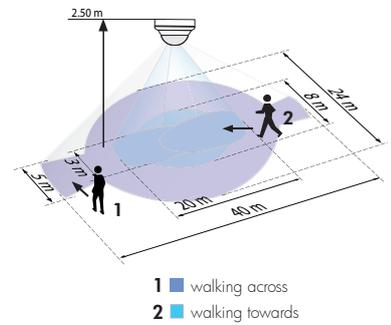

PD4-M-2C-C

17. Exclude sources of interferences

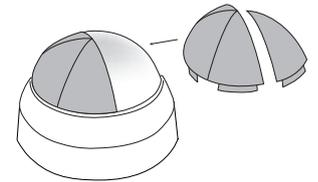

SM

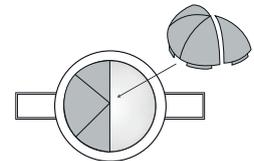

FC

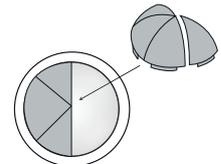

FM

In case the sensing area of the LUXOMAT® PD4-M-2C-C is too large or areas are being covered that should not be monitored, the range can be reduced or limited through use of the enclosed masking clips.

18. Article / Part nr. / Accessory

Typ	SM	FC	FM
PD4-M-2C-C (Master)	92440	92143	92443
PD4-S-C (Slave)	92442	92444	92445

LUXOMAT® Remote control:
IR-PD-2C (incl. wall bracket)

92475

Accessory:

BSK Ball basket guard

92199

19. Technical data PD4-Master-2C

Sensor and power supply in one case
Power supply: 230V~ ±10%
Power consumption: < 1W
Ambient temperature: -25°C to +50°C
Degree of protection / class: SM=IP54 FC/FM=IP20/II
Settings: Potentiometer, DIP-switch and by remote control

Light values:
 20 - 1000 Lux (with remote control)
 10 - 2000 Lux (with potentiometer)
Extension of the detection area: with Slave-devices
Area of coverage: circular 360°
Range of coverage Ø H 2,50m / T = 18°C:
 frontal 20m / tangential 40m
Recommended height for mounting: 2.40 - 2.60m

Light measurement:
 mixed light, daylight + artificial light

• Channel 1 for light control

Type of contact: NOC/with pretravel tungsten contact

Contact load: 2300 W cos φ=1 / 1150 VA cos φ=0.5, μ-Contact

Time-settings:
 15 sec. - 15 min./ test with potentiometer
 5 min. - 30 min./ test with remote control

• Channel 2 for control devices (only reacts on motion)

Contact load: 230V~, 3 A cos φ=1, μ-Contact

Time-settings: 5 min. - 120 min. with time delay of 5 min. for follow-up time > 15 min./ Alarm impulse

Dimensions H x Ø [mm]:

PD4-M-2C-C SM FC FM
 76 x 101 97 x 103 84 x 97

Visible portion when built into ceiling FC: 34 x 10 mm

Technical data PD4-Slave

Power supply: 230V~ ±10%

Impulse output: Optocoupler max. 2W

Impulse duration: 2 sec. or 9 sec

Dimensions: see above

CE **Declaration of Conformity:** The product complies with the low voltage recommendation 2006/95/EC and the EMV recommendation 2004/108/EC.

20. Wiring diagram

Standard operation Master/Slave

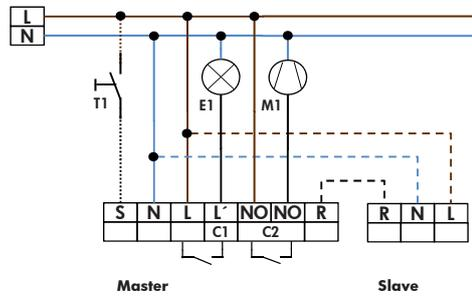

M1 = HVAC function

Optional

T1 = NO-button for semi automatic mode;
 Extension of the detection area with Slave-devices

21. PD4-M-2C-C-SM - Connections

Wiring diagram
 PD4-M-2C-C-SM

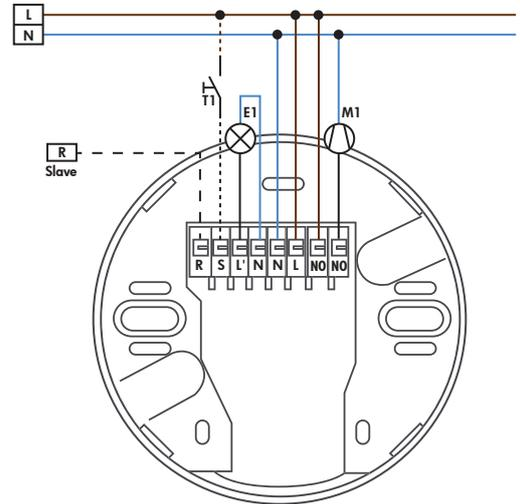

21. PD4-M-2C-C-FC - Connections

Wiring diagram
 PD4-M-2C-C-FC

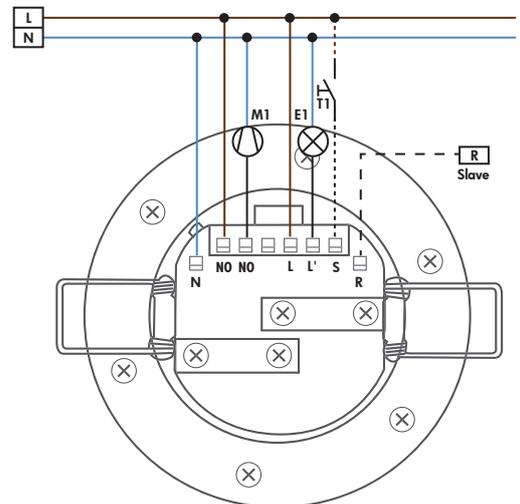

21. PD4-M-2C-C-FM - Connections

Wiring diagram
 PD4-M-2C-C-FM

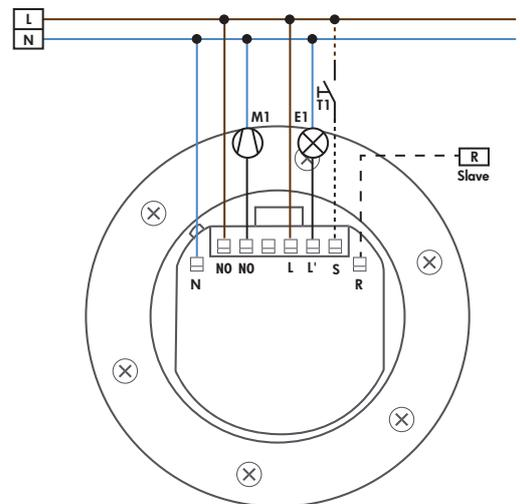

22. LED function displays

LED function indicators after each mains recovery (60 sec. initialisation period)			
Operating state	LED function indicators		
Factory program active	White, red and green flash in quick succession for 10 sec., then initialisation indicators, see below		
Double-locked	white and green shines for 5 sec. all 20 sec., afterwards initialising notification		
	Indicator unprogrammed	Indicator programmed	Indicator also when forced shutdown is activated
Standard mode	Red flashes	Red flashes quickly	Every 5 sec., 4 x white, red and green in quick succession
12 h ON/OFF active	Red and green flash	Red and green flash quickly	Every 5 sec., 4 x white, red and green in quick succession
Corridor active	Red and white flash	Red and white flash quickly	Every 5 sec., 4 x white, red and green in quick succession
12 h ON/OFF & corridor active	Red, green and white flash	Red, green and white flash quickly	Every 5 sec., 4 x white, red and green in quick succession
CdS active	-	Red and white flash	Then <u>no</u> red LED for motion detection

LED function indicators during operation	
Process	LED function indicators
Motion detection	Red flashes on each detected movement
Semi-automatic mode active	White is ON
Impulse active	Red and green flash one time all 4 sec.
Corridor active	White ON 1 sec. and OFF 4 sec.
Corridor and semi-automatic mode active	White ON 4 sec. and OFF 1 sec.
Too bright detected	Green flashes
Light measurement active	Green flashes once every 10 sec.
12 h ON/OFF function active	Red and green flash alternately
Duration ON active (by slave)	Red flashes quickly
IR command	White flashes once
IR command „Open“ and sabotage active	White and green flash once slowly