

unexLED.com

LED-LÖSUNGEN, BERATUNG UND PRODUKTE

Unex Dakota AG · Flüelastrasse 12 · CH-8048 Zürich

BETRIEBSANLEITUNG FÜR ZAKY LED

OPERATING MANUAL FOR ZAKY LED

MODE D'EMPLOI POUR ZAKY LED

ISTRUZIONI DI FUNZIONAMENTO PER ZAKY LED

116-059-70 / 3000K



220V-240V
~50/60Hz



LED
2x10W

IP65



CE

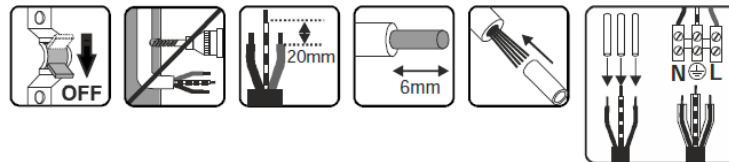

DEU Die Montage und Inbetriebnahme darf nur von autorisiertem Fachpersonaldurchgeführt werden (Elektroinstallateur). Die Leuchte dient ausschliesslich der Beleuchtung und ist entsprechend den Errichtungsbestimmungen zu installieren. Eine andere Nutzung oder ein anderer Einbau gilt als nicht „bestimmungsgemäss“.

Achtung! Während der Verdrahtung und Installation der Leuchten und Versorgungsgeräte immer spannungslos arbeiten. Nichtbeachten kann zur Zerstörung der LED-Module führen. **Bei Defekt zurück an Hersteller.** Montageanleitung muss aufbewahrt werden. Technische Änderungen vorbehalten.

FRA Le montage et la mise en service ne peuvent être effectués que par du personnel spécialisé autorisé (installateur électrique). Le luminaire sert uniquement à éclairer et doit être installé conformément aux dispositions d'édification. Une autre utilisation ou intégration est considérée comme «non conforme aux dispositions».

Attention! Toujours travailler hors tension lors du câblage et de l'installation des luminaires et unités d'alimentation. Le non-respect de cette consigne peut entraîner la destruction des modules à LED. **Retourner au fabricant en cas de défaut.** L'instruction de montage doit être conservée. Sous réserve de modifications.

ITA Montaggio e messa in funzione possono essere effettuati solo da personale specializzato autorizzato (elettoinstallatori). Il proiettore serve esclusivamente a scopo di illuminazione e deve essere installato secondo le disposizioni di montaggio. Un altro utilizzo o un'altra modalità di incasso sono considerati "non conformi".

Attenzione! Lavorare sempre in assenza di tensione mentre si cablano e si installano gli apparecchi e le unità di alimentazione. In caso contrario i moduli LED possono andare distrutti! **In caso di guasto rispedire il proiettore al produttore.** Le istruzioni di montaggio devono essere conservate. I dati tecnici possono subire modifiche senza preavviso.

ENG Installation and commissioning may only be carried out by authorised technical personnel (electrical fitters). The luminaire is designed solely for lighting and is to be installed according to the installation instructions. Any other use or any other installation is considered to be improper.

Caution! Make sure that the luminaires and power supply units are always disconnected from the main supply during wiring and installation work. Otherwise, the LED modules may be destroyed. **Return to manufacturer if defects are found.** Assembly instructions must be kept. Subject to technical change without notice.

1.

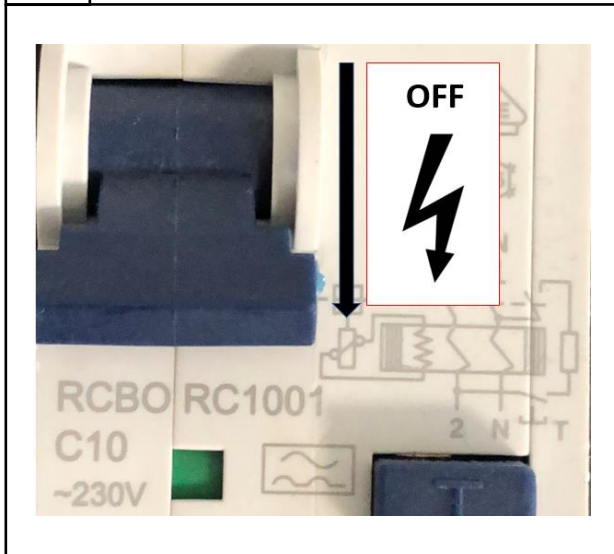

2.

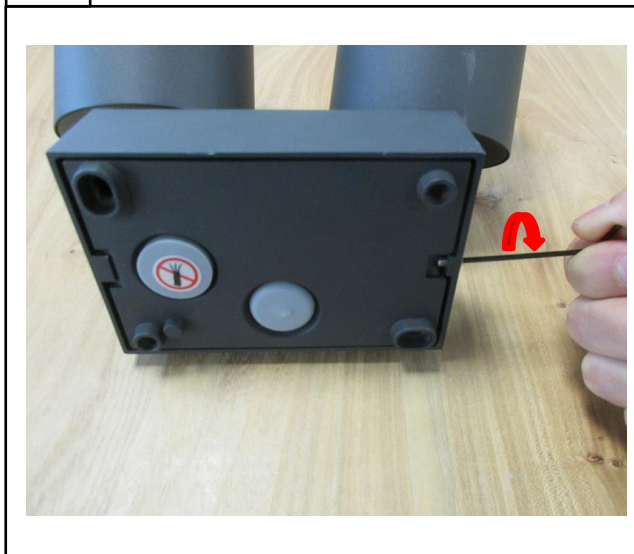

3.

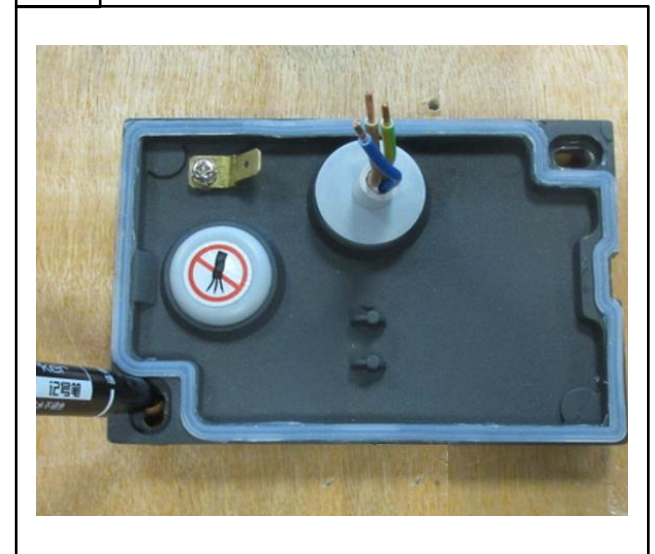

4.

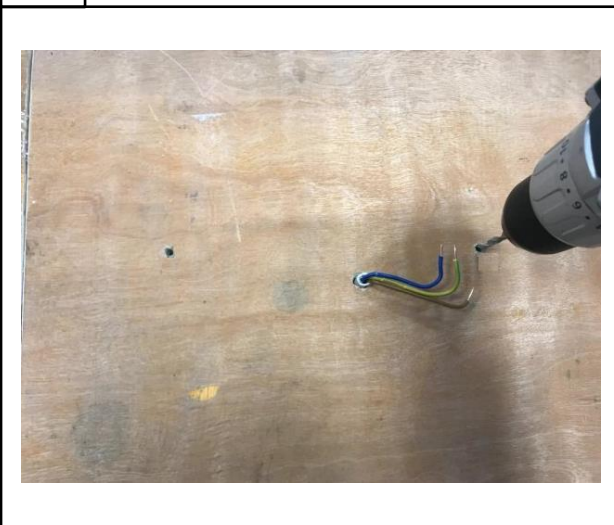

5.

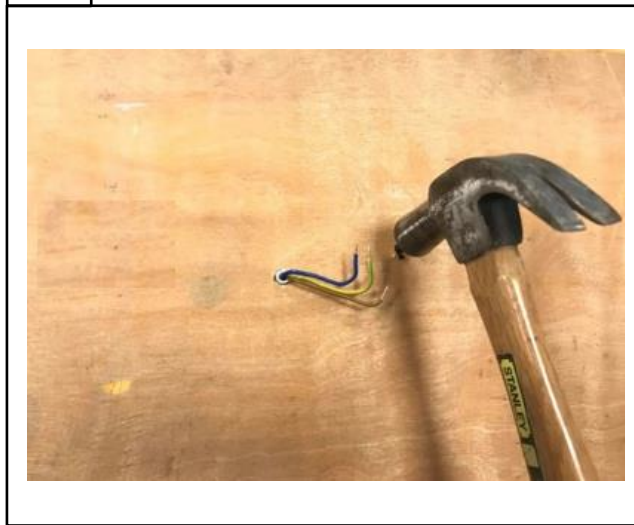

6.



Technische Änderungen vorbehalten, Sous réserve de modifications, Modifiche tecniche riservate, Reserve technical changes,
29.01.2019 © Unex Dakota AG, Flüelastrasse 12, CH-8048 Zürich, Schweiz, Tel: +41 44 404 22 22

7.



8.

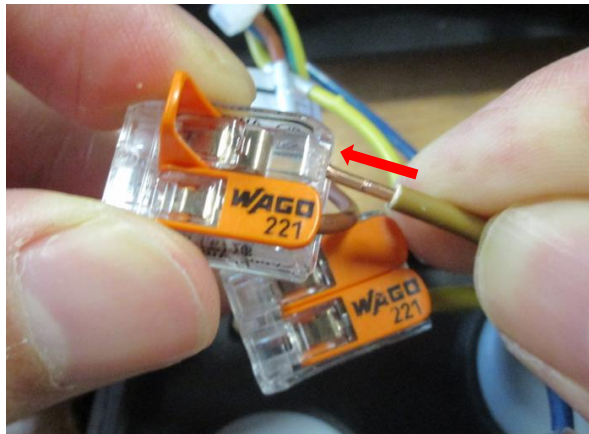

9.

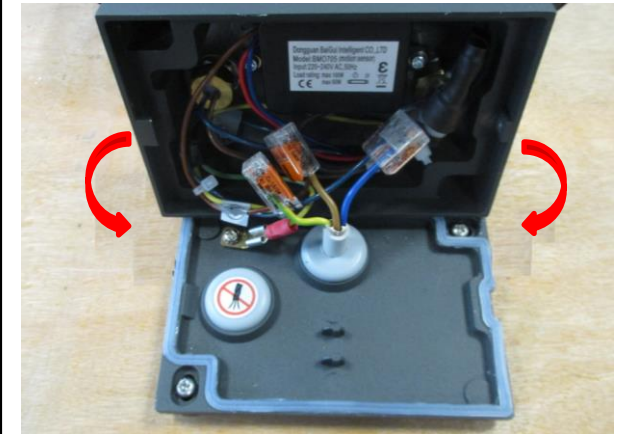

10.

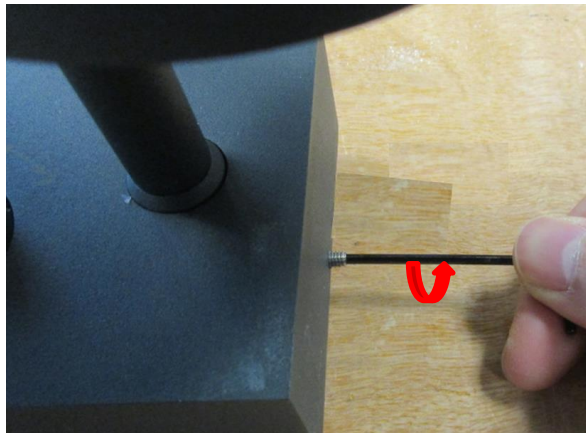

11.



12.



8s...12 min

3... 1000 LUX

Technische Änderungen vorbehalten, Sous réserve de modifications, Modifiche tecniche riservate, Reserve technical changes,
 29.01.2019 © Unex Dakota AG, Flüelastrasse 12, CH-8048 Zürich, Schweiz, Tel: +41 44 404 22 22

13.

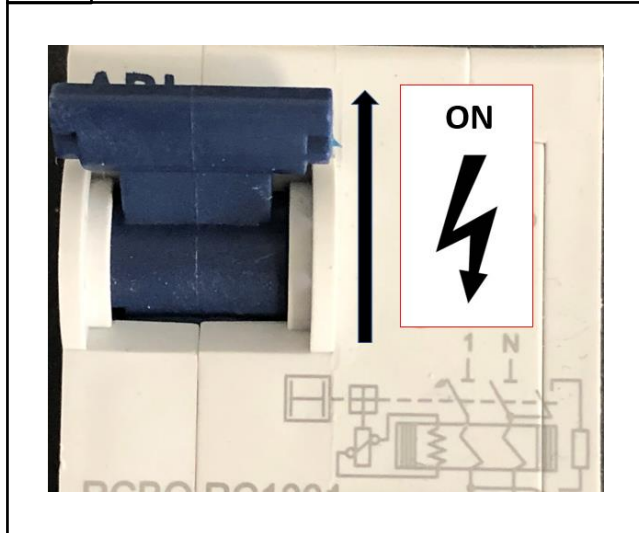

14.



Reinigung und Pflege | Nettoyage et entretien | Cura e pulizia | Cleaning and care

DE Reinigung nur mit trockenem oder feuchtem Mikrofaser Tuch.

FR Nettoyage seulement avec chiffon microfibre sec ou humide.

IT Pulire solo con un panno in microfibra asciutto o umido.

EN Only use dry or moist microfiber cloth for cleaning.

*Technische Änderungen vorbehalten,
Sous réserve de modifications,
Modifiche tecniche riservate,
Reserve technical changes,
29.01.2019 © Unex Dakota AG
AGB's / CGV / Sales conditions: www.unexLED.ch*